

SCHRAUBEN- VEREINZELNER



Tools & Service

Schöffner

Features of Automatic Screw / Bolt Feeders

Automatic screw feeders make use of a horizontal rail system. Supporting a wide range of materials and shapes, these units accommodate diverse workstyles and workpiece dimensions. The unique mechanism and advanced technology hugely contribute to the efficiency of your production line.

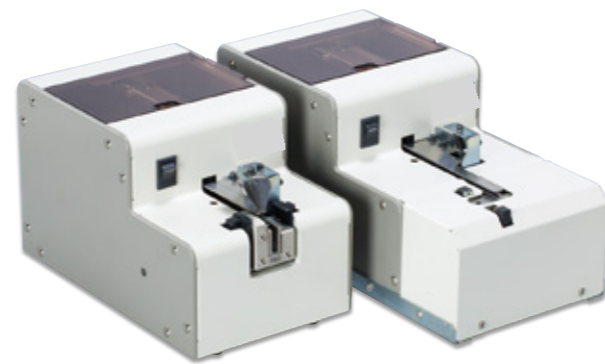

High-Speed and Smooth



Fixed Point Take Out



Fixed Quantity Take Out



Also supports screws with washers or special formats

Horizontal rail realizes the smooth feed of numerous types of special screws, among them those with washers and with short under-head length.



Normal screw

With washer

Nut

Special parts

Other key features

- Easy to handle and operate: simply install once to get up and running. All you have to do is push the power switch.
- Adding screws is a snap. Simply insert in bulk in the scooping chamber.
- Takes 5 seconds with a single hex wrench to swap and accommodate the screw diameter changes (NJ/NSB type). Simply loosen the rail-tightening screws, swap in a new rail, and adjust the position while tightening the screws back into place.
- In the event that too many screws are inserted or have become clogged, the unit automatically cuts the power to the drive motor and shuts off.



Compatible to line changes for adjustments to screw diameter and shape Supporting QC and productivity improvements

Automatic screw feeders dramatically increase the speed of screw tightening work. Designed with ease of use in mind, and employing the world's first rail-swappable mechanism, these devices let you work with screws of varying diameters and formats. Even when changing workpiece entails different screw diameters, all you need to do is swap in a new rail. No need to replace the feed mechanism itself, which means reduction of equipment costs. Horizontal rail mechanism offers speedy and stable screw feeding. Highly versatile design and ease of use drive the high efficiency of screw tightening work.



Horizontal rail provides stable, orderly array of screws

Unlike gravity-based feed mechanisms, this one uses a vibration to convey screws in a horizontal rail. Does away with problems like screw clogging and stably feeds even screws with washers attached.

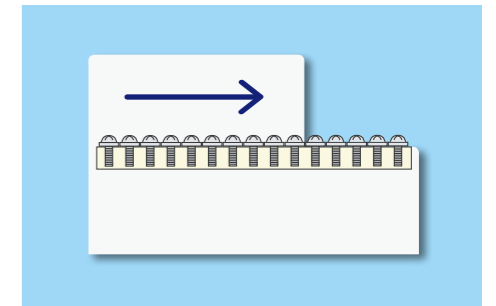

Average screw feed time is 2 per second

Achieve a three- to fivefold increase in working speed based on traditional manual work. Average screw take out of 2 per second greatly improves working efficiency.

Makes work easier

Now you can tighten screws with one hand, improving the stability and efficiency of assembly work.

Supports standard bits from various screwdriver manufacturers

No need to attach a specialized bit to electric screwdrivers. Immediately use standard bits you are accustomed to using. Conveys magnetized bits perpendicularly along the V-shaped groove of the bit guide, engaging the screw head and allowing it to be caught by simply pulling it close. Supports suction-style screwdrivers.

Accommodate different screw diameters by simply swapping rails

Simply swapping in the rail for a given screw diameter offers support for numerous screw types. For example, NSB models support up to 8 screw diameters in a single device.

Some models require exchanging parts in addition to swapping the rail.

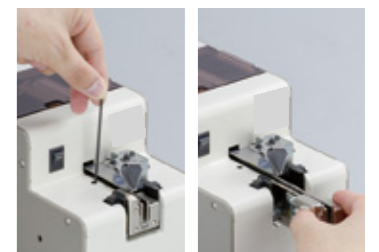

Selection Process

1 Select by use

First, select your use from "manual," "robotic," and "fixed quantity take out."

2 Select by workpiece diameter

Select models based on the diameter of workpiece you use (as indicated by ●).

3 Select by workpiece length (based on the longest ones)

Select models based on the length of the workpiece—under-head length for feeders, and total length for screw hoppers.

4 Select by workpiece material

Select models based on the material of the workpiece.

Please have a look at the product page.

List of Models

1	2																3	4	Capacity	Take out type	Drive method	Supported screw hopper	Features	Pages			
	Application	Series name	Exterior appearance	Model name	Supported screw and bolt size (by workpiece diameter)																				Supported screw/bolt Maximum under-head length	Supported materials	
				S0.5 ~S1.0	M1.0	M1.2	M1.4	M1.7	M2.0	M2.3	M2.6	M3.0	M3.5	M4.0	M5.0	M6.0	M8.0										
Manual	NJ		NJ-23						●	●	●	●							18mm	Rail + bit guide A	Cam (not adjustable)	NJ-80 / T-510J / RHP-160J / *MHP-80J	-	5 page			
			NJC-23						●	●	●	●							25mm				With counter				
			NJL-23						●	●	●	●							18mm				-				
			NJ-45											●	●	●	●	Special	25mm				With counter				
			NJC-45												●	●	●	●					-				
	NSB		NSB		●	●	●	●	●	●	●	●	●						20mm	Rail + bit guide B	Cam (screw adjustable)	SR-80 / T-510S / *MHP-80S	-	7 page			
			NSBC		●	●	●	●	●	●	●	●	●										With counter				
	NSBI		NSBI		●	●	●	●	●	●	●	●	●						16mm	Rotating escaper + bit guide B	Solenoid (volume adjustment)	None	-	14 page			
			SS-12		●	●	●	●	●	●	●	●	●										-				
	SS		SS-23																25mm	Rail + bit guide C	Solenoid (volume adjustment)	None	-	15 page			
			SS-23																				-				
	SSI-M		SSI-12M		●	●	●	●	●	●	●	●	●						25mm	Rotating escaper + bit guide B	Solenoid (volume adjustment)	None	-	11 page			
SSI-23M																		-									
OM-26M		OM-26M							●	●	●	●	●	●	●	●	●	25mm	Rotating escaper + bit guide A	Solenoid (volume adjustment)	RHP-160M / *MHP-80M	-	19 page				
		OM-26M (T063)																				Remaining quantity sensor (optional)					
LS-HM		LS25-HM																25mm	Rotating escaper + bit guide D	Solenoid (volume adjustment)	None	Remaining quantity sensor (optional)	19 page				
		LS50-HM																50mm				-					
Robotic	NJR		NJR-23						●	●	●	●						18mm	Slide	Cam (not adjustable)	NJ-80 / T-510J / RHP-160J / *MHP-80J	-	5 page				
			NJRL-23						●	●	●	●						25mm				-					
			NJR-45												●	●	●	Special				18mm		-			
			NJRL-45															Special				25mm		-			
	NSR		NSR		●	●	●	●	●	●	●	●	●						20mm	Slide	Cam (screw adjustable)	SR-80 / T-510S / *MHP-80S	-	7 page			
			NSRI		●	●	●	●	●	●	●	●	●										Rotating escaper		-		
	SSI-R		SSI-12R		●	●	●	●	●	●	●	●	●						16mm	Rotating escaper	Solenoid (volume adjustment)	None	-	15 page			
			SSI-23R																				-				
	OM-26R		OM-26R							●	●	●	●	●	●	●	●	●	25mm	Rotating escaper	Solenoid (volume adjustment)	RHP-160M / *MHP-80M	-	11 page			
			OM-26R (T063)																				Remaining quantity sensor				
	LS-HR		LS25-HR																25mm	Rotating escaper	Solenoid (volume adjustment)	None	Remaining quantity sensor (optional)	19 page			
			LS50-HR																50mm				-				
MSF		MSF	●															5mm	Rotating escaper	Solenoid (volume adjustment)	None	-	13 page				
Fixed quantity take out	FM-36		FM-36															25mm	Lever	Cam (not adjustable)	NJ-80F / T-510F / RHP-160F / *MHP-80F	-	17 page				
			FME-36																					Communication functionality			
	LV		LV25																25mm	Lever Miscellaneous	Solenoid (volume adjustment)	None	Remaining quantity sensor (optional)	19 page			
LV50																		50mm	-								

*For the screw hopper, the compatible length of the screw may differ from that of the feeder it is combined with. Please check their compatibility before use.
*Depending on the shape of the screw, the screw hopper may not be compatible with it.

*MHP-80 is compatible only with iron screws (due to the use of a magnet).

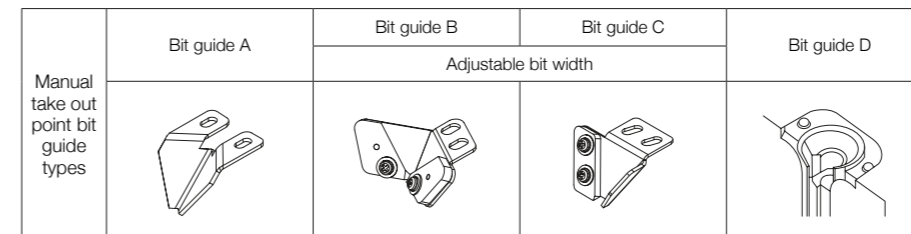
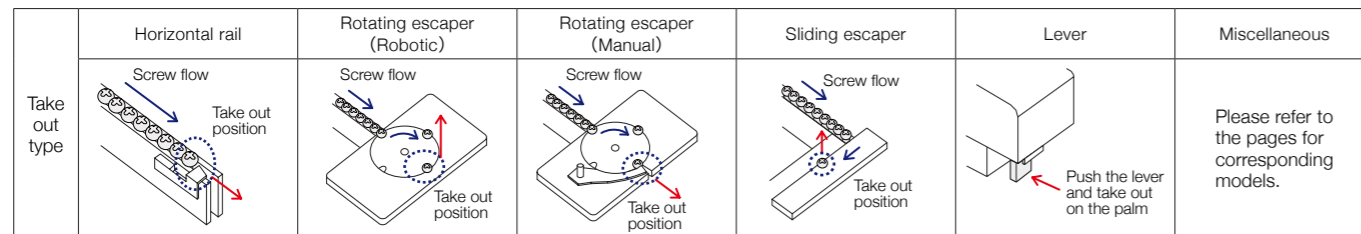

Index

Features

P 1 Features of Automatic Screw / Bolt Feeders

Selecting Models and the Model List

P 3 Selection Process / List of Models

P 4 Index

Product Lineup

P 5 **NJ/NJR Series**
All-around Screw Feeder

P 7 **NSB/NSR Series**
Versatile Screw Feeder

P 9 **NSBI/NSRI Series**
Versatile Screw Feeder

P 11 **OM-26M/OM-26R Series**
High-speed and High-capacity Iron Screw Feeder

P 13 **MSF Series**
Micro-screw Feeder

P 14 **SS Series**
Slim Screw Feeder

P 15 **SSI-M/SSI-R Series**
Slim Screw Feeder

P 17 **FM Series**
Fixed Quantity Count / External Configuration Type Screw Feeder

P 19 **LS/LV/LF Series**
Large Longneck Screw Feeder

P 21 **BS Series**
Pneumatic Screw Feeder

P 23 **Screw Hopper**

FAQ

P 25 FAQ

Signals obtained from signal line

Automatic screw feeder AC adapter plug formats

NJ / NJR Series All-around Screw Feeder

Supports a wider screw diameter than the NSB/NSR series and has greater capacity, making it even more useful.

Supported screw diameter M2.0 ~ M5.0	Supported screw under-head length Longest: 18 / 25mm	Capacity About 150 cc	Non-ferrous materials: supported
---	---	--------------------------	----------------------------------

*For details, please refer to each product's specifications section.

Manual	NJ-23	NJ-45	NJL-23	NJL-45	NJC-23	NJC-45
Robotic	NJR-23	NJR-45	NJRL-23	NJRL-45		

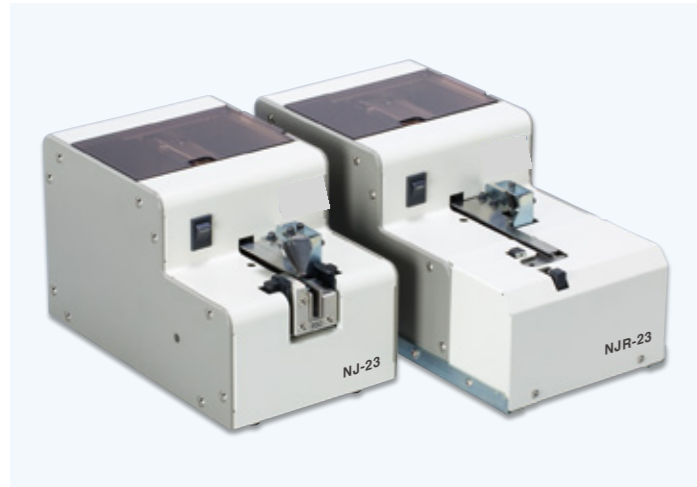

Supports standard bits from various screwdriver manufacturers

- Bit screwdrivers
- Suction screwdrivers

Large stock

Supports a stock of 150cc.

Special screws supported

Allows you to stably feed SW screws or those with washers.

Long-running operation when combined with screw hopper

Use a screw hopper for long-running unmanned operation.

Smooth screw feeding

- Provides ongoing, timely feed of screws to match robot operations.
- The NJ type allows for sending out the screw take-out signal through an external outlet.
- The NSR type allows for the sending out of a signal to notify whether a screw is present at a screw take-out point through an external outlet.



NJ Series: Swap rail set (passing plate, rail)

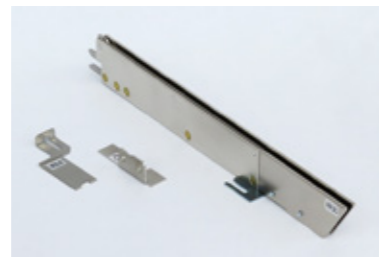

NJR Series: Swap rail set (passing plate, escaper, rail)



*NJ Series: Swap rail set (retainer plate for countersunk screws)

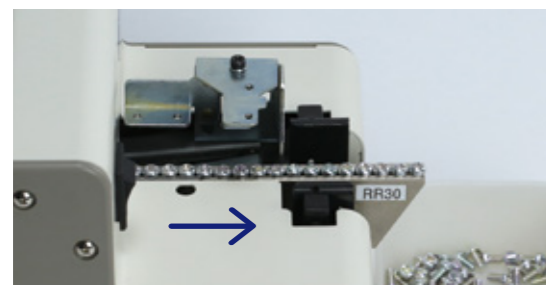

Sample applications / NJ + RR (rail for robotic devices)

Swap rails in/out.

This single unit supports a wide range of screws. For example, the NJ-23 supports four types of screw in a single unit. Allows for adjusting the angle of rail inclination based on the screw being used.

Example usage of combining NJ and RR rails

Use as a horizontal feeder for continuous feed to robotic devices. If you are seeking the same functionality in a different model, please contact us.

*If you are looking for equivalent parts for other models, please inquire.

Manual Type



NJ-23 NJ-45

NJL-23 NJL-45

Robotic Type

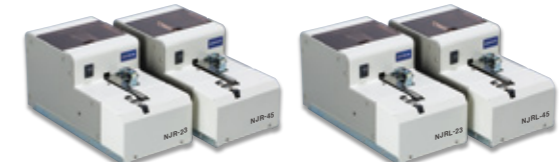

NJR-23 NJR-45

NJRL-23 NJRL-45

With a Counter



NJC-23 NJC-45

Product type

Supported screw diameter (mm)	Main component type					Swap rail set type				
	NJ Series	NJL Series	NJR Series	NJRL Series	NJC Series	NJ Series	NJL Series	NJR Series	NJRL Series	NJC Series
2.0	NJ-2320	NJL-2320	NJR-2320	NJRL-2320	NJC-2320	R20SET	RL20SET	RR20SET	RRL20SET	R20SET
2.3	NJ-2323	NJL-2323	NJR-2323	NJRL-2323	NJC-2323	R23SET	RL23SET	RR23SET	RRL23SET	R23SET
2.6	NJ-2326	NJL-2326	NJR-2326	NJRL-2326	NJC-2326	R26SET	RL26SET	RR26SET	RRL26SET	R26SET
3.0	NJ-2330	NJL-2330	NJR-2330	NJRL-2330	NJC-2330	R30SET	RL30SET	RR30SET	RRL30SET	R30SET
3.5	NJ-4535	NJL-4535	NJR-4535	NJRL-4535	NJC-4535	R35SET	RL35SET	RR35SET	RRL35SET	R35SET
4.0	NJ-4540	NJL-4540	NJR-4540	NJRL-4540	NJC-4540	R40SET	RL40SET	RR40SET	RRL40SET	R40SET
5.0	NJ-4550	NJL-4550	NJC-4550	NJRL-4550	NJC-4550	R50SET	RL50SET	RR50SET	RRL50SET	R50SET

Model Diagrams

Full diagrams of each model can be downloaded from our website.

NJ Series

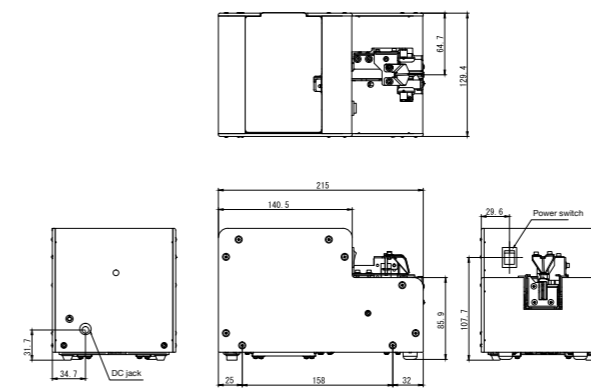

NJR Series

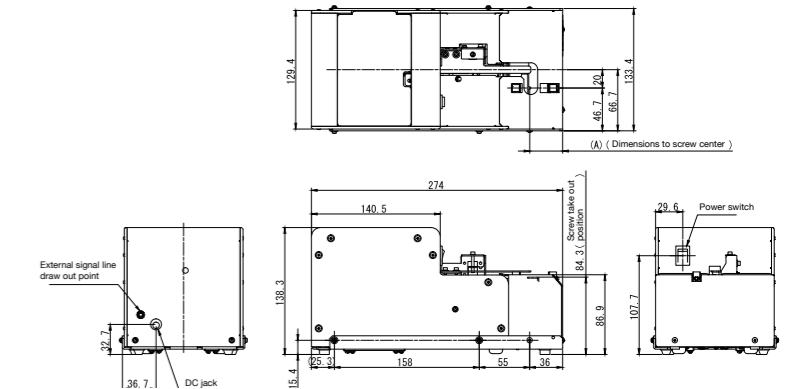

Specifications

Model name	NJ-23	NJ-45	NJL-23	NJL-45	NJR-23	NJR-45	NJRL-23	NJRL-45	NJC-23	NJC-45
Exterior dimensions	134(W)×215(D)×139(H)				134(W)×274(D)×139(H)				134(W)×215(D)×139(H)	
Volume (including the rail)	Approx. 3.7kgf				Approx. 4.4kgf				Approx. 3.7kgf	
Power	AC100V ~ 240V DC15V 1A AC adapter									
Drive motor	DC brush motor									
Overload protection/recovery circuit	○	○	○	○	○	○	○	○	○	○
External signal line	○	○	○	○	○	○	○	○	○	○
Brush overload protection mechanism	○	○	○	○	○	○	○	○	○	○
Yield time	-	-	-	-	Approx. 1.5sec				-	-
Supported screw diameter	φ 2.0~φ 3.0	φ 3.5~φ 5.0	φ 2.0~φ 3.0	φ 3.5~φ 5.0	M2.0~M3.0	M3.5~M5.0	M2.0~M3.0	M3.5~M5.0	M2.0~M3.0	M3.5~M5.0
Supported screw under-head length	Up to 18 mm in length		Up to 25 mm in length		Up to 18 mm in length		Up to 25 mm in length		Up to 18 mm in length	
Screw capacity	Approx. 150cc									
Accessories and bundled items	Instruction manual, AC adapter, hex wrench, adjusting screwdriver, earth wire									

NSB / NSR Series Versatile Screw Feeder

Swapping rails allows you to accommodate various screw diameters with a single unit. Almost no screw is incompatible.

Supported screw diameter M1.0 ~ M3.0	Supported screw under-head length Longest: 20mm	Capacity About 80cc	Non-ferrous materials: supported
---	--	------------------------	----------------------------------

Manual	NSB NSBC
Robotic	NSR



⊕ Screws are moved smoothly, and durability has been improved dramatically

- < Improved screw chamber >
Reduces strain on the motor for more efficient screw alignment.
- < Adjustable rail angle >
Allows for adjusting the angle of rail inclination based on the screw being used.
- < Amplitude adjustment >
Allows for calibrating amplitude based on the type of screw being used.
- < No side-to-side vibration >
Alleviates side-to-side rail vibration to achieve smooth screw conveyance.

⊕ Other Key Features

- Compact size does not take up space.
- Use a screw hopper for high-capacity stock of screws.
- The NSR type features a screw take out point with a signal notifying whether a screw is present.
- The NSB type allows for sending out the signal of screw take out through an external outlet.

■ A single unit supports 8 different screw diameters.

- The NSB type supports 8 types of screw diameters by simply swapping rails. (Supports 8 types—from M1.0 to M.30—by default)
- The NSR type supports this through simply swapping the rail and escaper. Clean up oil and other stains easily by removing rail from behind.



NSB rail



NSR rails and escapers

■ One-touch rail swap

Swapping rails is also easy. Also allows you to easily swap rails based on changes in screw diameter. (NSB type)



Manual Type



NSB

Robotic Type



NSR

With a Counter



NSBC

Product type

Supported screw diameter (mm)	Main component type			Swap rail set type		
	NSB Series	NSR Series	NSBC Series	NSB Series	NSR Series	NSBC Series
1.0	NSB-10	NSR-10	NSBC-10	SR10SET	SRR10SET	SR10SET
1.2	NSB-12	NSR-12	NSBC-12	SR12SET	SRR12SET	SR12SET
1.4	NSB-14	NSR-14	NSBC-14	SR14SET	SRR14SET	SR14SET
1.7	NSB-17	NSR-17	NSBC-17	SR17SET	SRR17SET	SR17SET
2.0	NSB-20	NSR-20	NSBC-20	SR20SET	SRR20SET	SR20SET
2.3	NSB-23	NSR-23	NSBC-23	SR23SET	SRR23SET	SR23SET
2.6	NSB-26	NSR-26	NSBC-26	SR26SET	SRR26SET	SR26SET
3.0	NSB-30	NSR-30	NSBC-30	SR30SET	SRR30SET	SR30SET

Model Diagrams

Full diagrams of each model can be downloaded from our website.

NSB Series

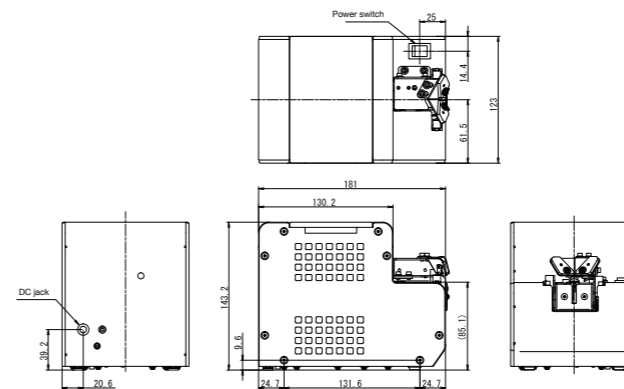

NSR Series

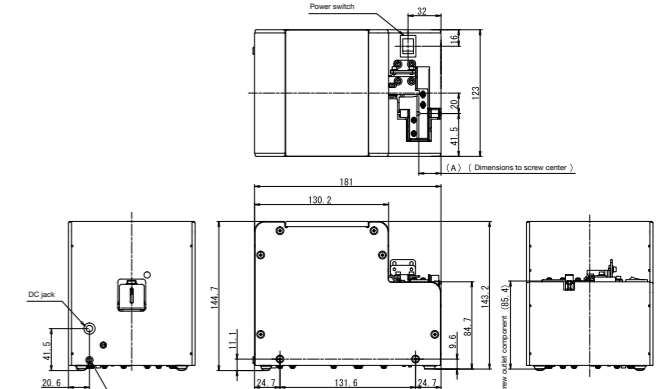

Specifications

Model name	NSB	NSR	NSBC
Exterior dimensions	123(W)×181(D)×145(H)		
Volume (including the rail)	Approx. 2.9kgf	Approx. 3.0kgf	Approx. 2.9kgf
Power	AC100V ~ 240V DC15V 1A AC adapter		
Drive motor	DC brush motor		
Overload protection/recovery circuit	○	○	○
External signal line	○	○	○
Escaper electric break function	-	○	-
Yield time	-	Approx. 1.5sec	-
Supported screw diameter	M1.0 ~ M3.0		
Supported screw under-head length	Up to 20 mm in length		
Screw capacity	Approx. 80cc		
Accessories and bundled items	Instruction manual, AC adapter, hex wrench, adjusting screwdriver, 0.35 mm gauge plate, earth wire	Instruction manual, AC adapter, hex wrench, adjusting screwdriver, earth wire	Instruction manual, AC adapter, hex wrench, adjusting screwdriver, 0.35 mm gauge plate, earth wire

NSBI / NSRI Series Versatile Screw Feeder

High-precision, High-speed,
and High-durability

Supported screw diameter M1.0 ~ M3.0	Supported screw under-head length Longest: 20mm	Capacity About 80cc	Non-ferrous materials: supported
---	--	------------------------	----------------------------------

*For details, please refer to each product's specifications section.

Manual NSBI
Robotic NSRI NSRI-B (With Brushless Motor)

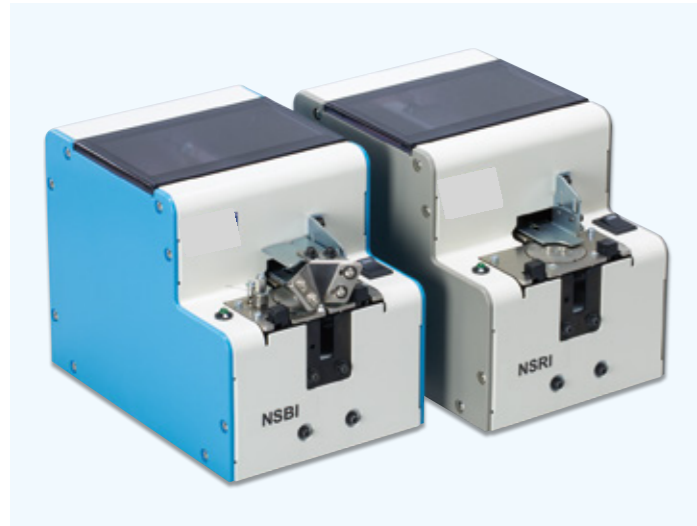

⊕ Features a rotary escaper

Separates screws one at a time, ensuring they do not intersect for smooth take out.

⊕ Special screws supported

Allows you to stably feed SW screws or those with washers.

⊕ Dramatic improvements in motor durability

NSRI-B: includes a brushless motor. The motor now has a greatly improved lifecycle. (3x greater)

⊕ Flexible support for line changes

Supports screws of varying diameters. Easy installation: simply set into place, and the portable size lets you adapt to line or workpiece changes.



NSRI-B robotic device installation example

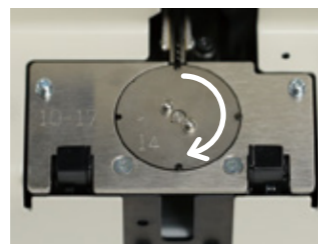

Rotating escaper

NSRI-B robotic device installation example

- Easy installation—simply drop into place. Makes maintenance and replacement easy.
- NSRI/NSRI-B: screw take out point features a signal notifying whether the screw is at the take out point.

Escaper

- < Rotating escaper allows for high-speed screw supply >
- Accurately separates screws and supplies them at high speed.
- < Supports low profile screws >
- By default, supports up to 0.35mm (or 0.2mm by special order) low profile screws.
- Separates screws one at a time, ensuring they do not clog at the take out outlet.

Manual Type



NSBI

Robotic Type



NSRI

With Brushless Motor

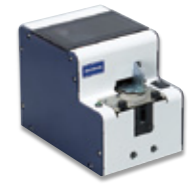

NSRI-B

Product type

Supported screw diameter (mm)	Main component type			Swap rail set type		
	NSBI Series	NSRI Series	NSRI-B Series	NSBI Series	NSRI Series	NSRI-B Series
1.0	NSBI-10	NSRI-10	NSRI-10B	BI10SET	RI10SET	RI10SET2
1.2	NSBI-12	NSRI-12	NSRI-12B	BI12SET	RI12SET	RI12SET2
1.4	NSBI-14	NSRI-14	NSRI-14B	BI14SET	RI14SET	RI14SET2
1.7	NSBI-17	NSRI-17	NSRI-17B	BI17SET	RI17SET	RI17SET2
2.0	NSBI-20	NSRI-20	NSRI-20B	BI20SET	RI20SET	RI20SET2
2.3	NSBI-23	NSRI-23	NSRI-23B	BI23SET	RI23SET	RI23SET2
2.6	NSBI-26	NSRI-26	NSRI-26B	BI26SET	RI26SET	RI26SET2
3.0	NSBI-30	NSRI-30	NSRI-30B	BI30SET	RI30SET	RI30SET2

Model Diagrams

Full diagrams of each model can be downloaded from our website.

NSBI Series

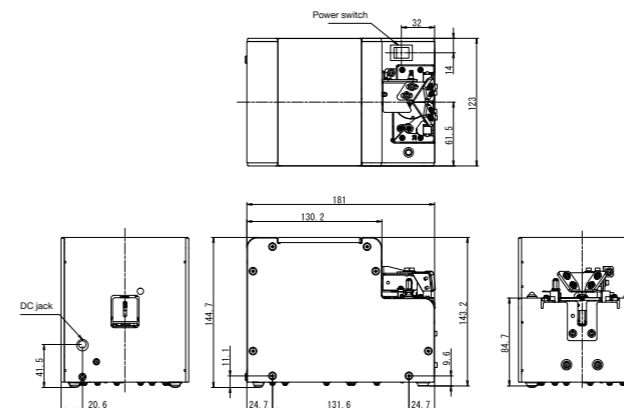

NSRI Series

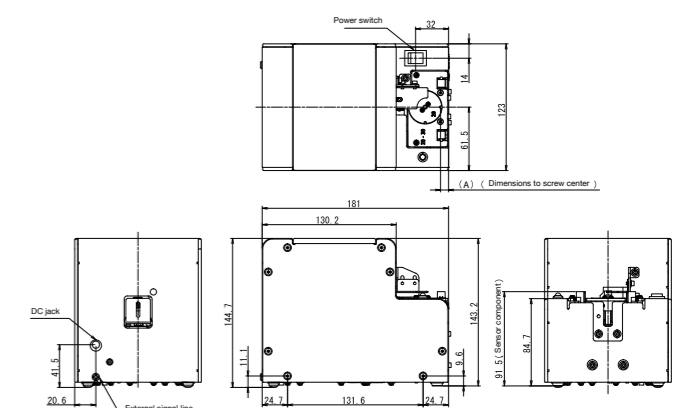

Specifications

Model name	NSBI	NSRI	NSRI-B
Exterior dimensions	123(W)×181(D)×145(H)		
Volume (including the rail)	Approx. 3.0kgf		
Power	AC100V ~ 240V DC15V 1A AC adapter		
Drive motor	DC brush motor · Stepper motor		DC brushless motor · Stepper motor
Overload protection/recovery circuit	<input type="checkbox"/>	<input type="checkbox"/>	<input type="checkbox"/>
External signal line	<input type="checkbox"/>	<input type="checkbox"/>	<input type="checkbox"/>
Escaper S-shape controlling function	<input type="checkbox"/>	<input type="checkbox"/>	<input type="checkbox"/>
Escaper rotation time lag adjustment function	-	-	<input type="checkbox"/>
Yield time	Approx. 0.9sec		
Supported screw diameter	M1.0 ~ M3.0		
Supported screw under-head length	Up to 20 mm in length		
Screw capacity	Approx. 80cc		
Accessories and bundled items	Instruction manual, AC adapter, hex wrench, adjusting screwdriver, earth wire		

OM-26M / OM-26R Series High-speed and High-capacity Iron Screw Feeder

High-capacity model: 300cc
(only supports iron screws)

Supported screw diameter M2.0 ~ M6.0	Supported screw under-head length Longest: 25mm	Capacity About 300cc	For iron screws
---	--	-------------------------	-----------------

*For details, please refer to each product's specifications section.

Manual	OM-26M
Robotic	OM-26R OM-26RB (With Brushless Motor)



- ⊕ Features a rotary escaper**
Separates screws one at a time, ensuring they do not intersect for smooth take out.
- ⊕ Supports standard bits from various screwdriver manufacturers**
 - Bit screwdrivers
 - Suction screwdrivers
- ⊕ Large capacity: 300 cc**
Supports a stock of 780 M3.0x12mm washer faced screws.
- ⊕ Special screws supported**
Allows you to stably feed SW screws or those with washers.
- ⊕ Dramatic improvements in motor durability**
OM-26RB: equipped with a brushless motor. The motor now has a greatly improved lifecycle. (3x greater)

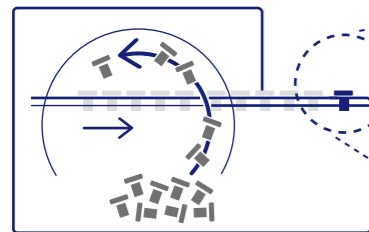

Magnetically conveys screws along rail for a stable feed.

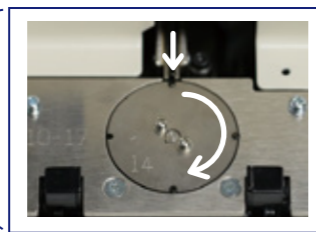

Rotating escaper

High-capacity screw stock (4x that of the NSB type)
Magnetically conveys screws along rail for a stable feed. Design prevents screws from getting stuck. The rotating escaper also isolates screws one at a time in order to prevent take out errors.

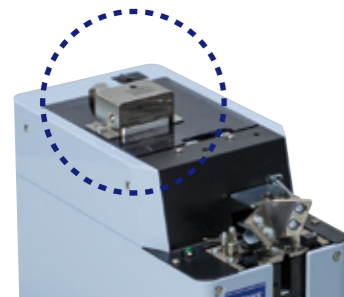

Optional: quantity sensor
OM-26R/M screw quantity sensor (TKA09452)
This is a screw quantity sensor (TKA09452) intended for use with the OM-26R/M Series Automatic Screw Feeder. Combine with the OM-26R/M in order to detect when the screw stock is low and send a signal. Please contact us regarding quantity sensors for other products.

Manual Type



OM-26M

Robotic Type



OM-26R

With Brushless Motor



OM-26RB

Product type

Supported screw diameter (mm)	Main component type			Swap rail set type		
	OM-26M Series	OM-26R Series	OM-26RB Series	OM-26M Series	OM-26R Series	OM-26RB Series
2.0	OM-26M20	OM-26R20	OM-26RB20	OMM20SET	OMR20SET	OMR20SET2
2.3	OM-26M23	OM-26R23	OM-26RB23	OMM23SET	OMR23SET	OMR23SET2
2.6	OM-26M26	OM-26R26	OM-26RB26	OMM26SET	OMR26SET	OMR26SET2
3.0	OM-26M30	OM-26R30	OM-26RB30	OMM30SET	OMR30SET	OMR30SET2
3.5	OM-26M35	OM-26R35	OM-26RB35	OMM35SET	OMR35SET	OMR35SET2
4.0	OM-26M40	OM-26R40	OM-26RB40	OMM40SET	OMR40SET	OMR40SET2
5.0	OM-26M50	OM-26R50	OM-26RB50	OMM50SET	OMR50SET	OMR50SET2
6.0	OM-26M60	OM-26R60	OM-26RB60	OMM60SET	OMR60SET	OMR60SET2

Model Diagrams

Full diagrams of each model can be downloaded from our website.

OM-26M Series

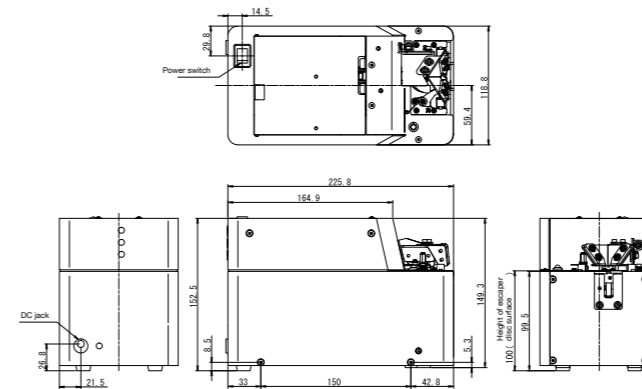

OM-26R Series

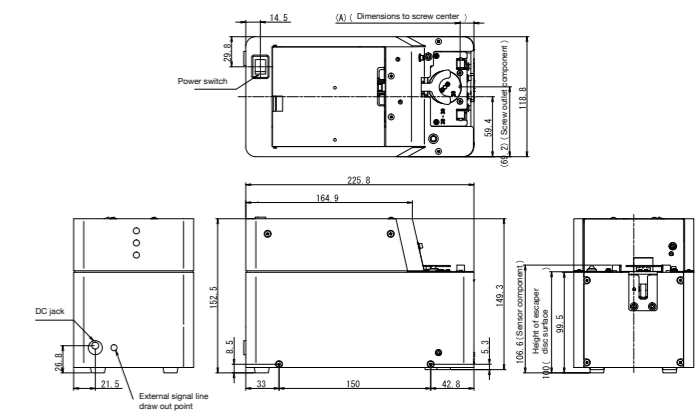

Specifications

Model name	OM-26M	OM-26R	OM-26RB
Exterior dimensions	119(W)×226(D)×152(H)		
Volume (including the rail)	Approx. 3.1kgf		
Power	AC100V ~ 240V DC15V 1A AC adapter		
Drive motor	DC brush motor · Stepper motor		DC brushless motor · Stepper motor
Overload protection/recovery circuit	○	○	○
External signal line	○	○	○
External signal line (remaining quantity sensor)	Optional		
Escaper S-shape controlling function	○	○	○
Escaper rotation time lag adjustment function	-	-	○
Yield time	Approx. 0.8sec		
Supported screw materials	Iron only		
Supported screw diameter	M2.0 ~ M6.0		
Supported screw under-head length	Up to 25 mm in length		
Screw capacity	Approx. 300cc		
Accessories and bundled items	Instruction manual, AC adapter, hex wrench, adjusting screwdriver, earth wire		

MSF Series Micro-screw Feeder

Supports screws as small as S0.5

Supported screw diameter M0.5 ~ M1.0	Supported screw under-head length Longest: 5mm	Capacity About 15cc	Non-ferrous materials: supported
---	---	------------------------	----------------------------------

*For details, please refer to each product's specifications section.

Robotic MSF

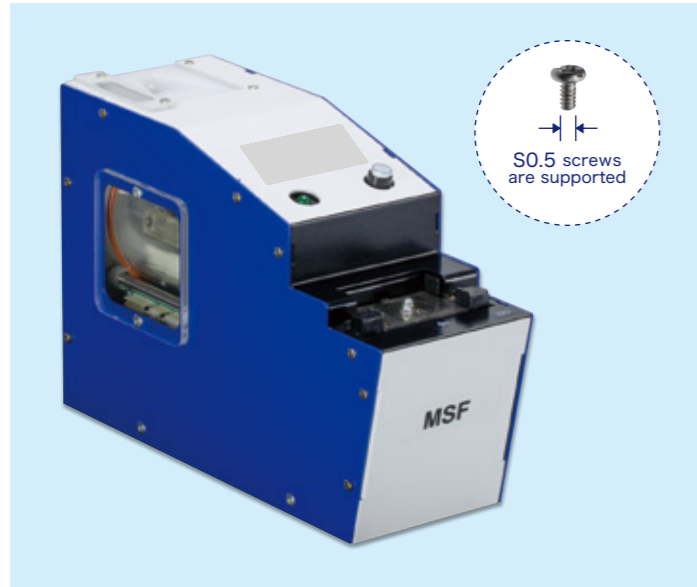

⊕ Accurately and reliably isolates tiny screws

Rotating escaper isolates even tiny screws one by one.

⊕ Space-saving slim design

Compact, 70mm-wide design saves space.

⊕ Simple installation

Easy installation—just set in place.

Example of installation for a robotic device

- Easy installation—simply drop into place. Makes maintenance and replacement easy.
- Screw take out point features a signal notifying whether the screw is at the take out point.
- Rotating escaper ensures accurate screw feed.



Specifications

Model name	MSF
Exterior dimensions	71(W)×194(D)×132(H)
Volume (including the rail)	Approx. 2kgf
Power	AC100V ~ 240V DC15V 1A AC adapter
Drive motor	DC brush motor · Stepper motor
External outlet terminal	○
Supported screw diameter	S0.5 ~ S1.0
Supported screw under-head length	1 ~ 5mm
Screw capacity	Approx. 15cc
Accessories and bundled items	Instruction manual, AC adapter, hex wrench, adjusting screwdriver, earth wire

Product type

Supported screw diameter (mm)	Main component type MSF Series
0.5	MSF-05
0.6	MSF-06
0.7	MSF-07
0.8	MSF-08
1.0	MSF-10

Model Diagrams

Full diagrams of each model can be downloaded from our website.

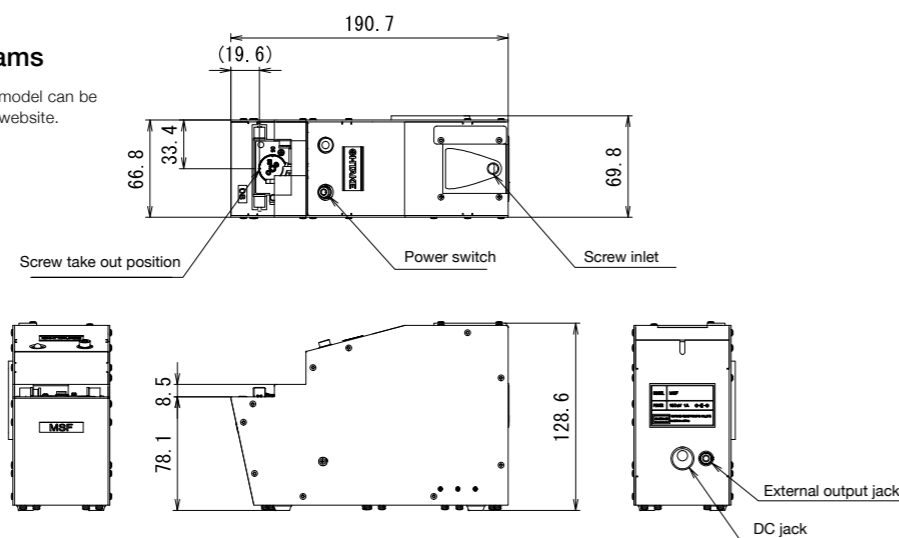

*Please inquire prior to placing an order.

SS Series Slim Screw Feeder

Super thin 55mm width is ideal for cell work

Supported screw diameter M1.0 ~ M3.0	Supported screw under-head length Longest: 16mm	Capacity About 40cc	Non-ferrous materials: supported
---	--	------------------------	----------------------------------

*For details, please refer to each product's specifications section.

Manual S-12 SS-23



⊕ Slim design that allows them to be installed next to each other.

In just half the width of the NJ/NS Series, you can fit two units for the space of a single NSB.

⊕ Supports low profile screws

Adjust sensor to support up to 0.25mm screw heads. (factory setting: 0.5mm)

⊕ Adjustable screw conveyor speed

Calibrate amplitude and frequency to achieve the ideal feed speed.

Space-saving for cell works and multiple screw-tightening work



Specifications

Model name	SS-12	SS-23
Exterior dimensions	55(W)×205(D)×143(H)	
Volume (including the rail)	Approx. 2.4kgf	
Power	AC100V ~ 240V DC15V 1A AC adapter	
Drive motor	DC brush motor	
Overload protection/recovery circuit	○	○
Supported screw diameter	M1.0 ~ M2.0	M2.3 ~ M3.0
Supported screw under-head length	Up to 16 mm in length	
Screw capacity	Approx. 40cc	
Accessories and bundled items	Instruction manual, AC adapter, hex wrench, adjusting screwdriver, earth wire	

Product type

Supported screw diameter (mm)	SS Series	
	Main component type	Swap rail set type
1.0	SS-1210	WR10
1.2	SS-1212	WR12
1.4	SS-1214	WR14
1.7	SS-1217	WR17
2.0	SS-1220	WR20
2.3	SS-2323	WR23
2.6	SS-2326	WR26
3.0	SS-2330	WR30

Model Diagrams

Full diagrams of each model can be downloaded from our website.

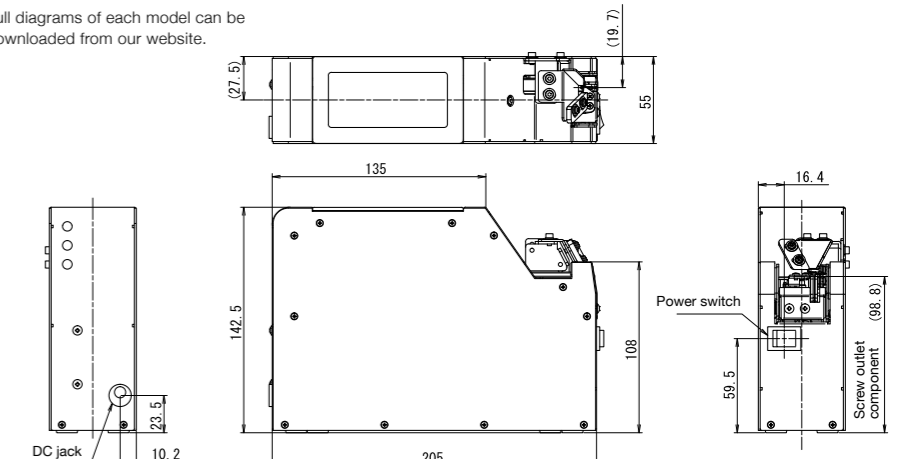

SSI-M / SSI-R Series Slim Screw Feeder

Compact size supports a wide range of assembly workflows and fits anywhere

Supported screw diameter M1.0 ~ M3.0	Supported screw under-head length Longest: 16mm	Capacity About 40cc	Non-ferrous materials: supported
---	--	------------------------	----------------------------------

*For details, please refer to each product's specifications section.

Manual SSI-12M SSI-23M
Robotic SSI-12R SSI-23R



Space-saving slim design

Compact, 65mm-wide design saves space.

Stable rail movement without clog

Horizontal rail system prevents screws from clogging or overlapping, achieving stable feed.

Integrated output designed for use with general counters

Send take out signal from output jack to connect a general-purpose counter.

Rear part description



SSI rear part

Frequency
Amplitude
Timer

Calibrate screw feed speed by frequency and vibration

Escaper

- < Rotating escaper allows for high-speed screw supply >
- Accurately separates screws and supplies them at high speed.
- < Supports low profile screws >
- By default, supports up to 0.35mm (or 0.2mm by special order) low profile screws.
- Separates screws one at a time, ensuring they do not clog at the take out outlet.

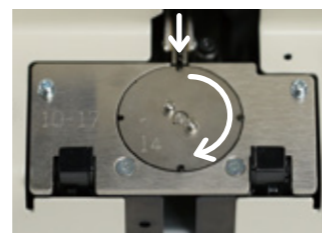

Rotating escaper

Manual Type



SSI-12M SSI-23M

Robotic Type



SSI-12R SSI-23R

Product type

Supported screw diameter (mm)	Main component type		Swap rail set type	
	SSI-M Series	SSI-R Series	SSI-M Series	SSI-R Series
1.0	SSI-12M10	SSI-12R10	SIM10SET	SIR10SET
1.2	SSI-12M12	SSI-12R12	SIM12SET	SIR12SET
1.4	SSI-12M14	SSI-12R14	SIM14SET	SIR14SET
1.7	SSI-12M17	SSI-12R17	SIM17SET	SIR17SET
2.0	SSI-12M20	SSI-12R20	SIM20SET	SIR20SET
2.3	SSI-23M23	SSI-23R23	SIM23SET	SIR23SET
2.6	SSI-23M26	SSI-23R26	SIM26SET	SIR26SET
3.0	SSI-23M30	SSI-23R30	SIM30SET	SIR30SET

Model Diagrams

Full diagrams of each model can be downloaded from our website.

SSI-M Series

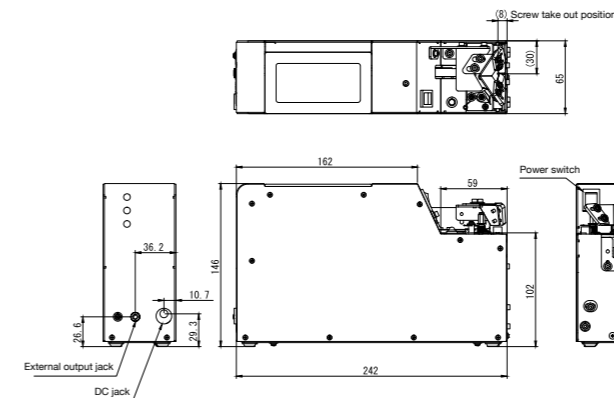

SSI-R Series

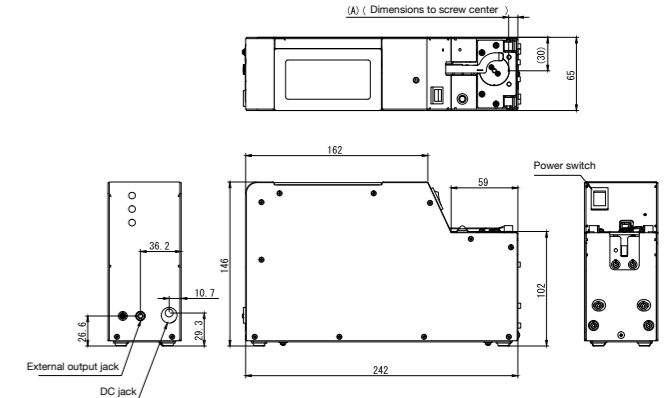

Specifications

Model name	SSI-12M	SSI-23M	SSI-12R	SSI-23R
Exterior dimensions	65(W)×242(D)×146(H)			
Volume (including the rail)	Approx. 3.3kgf		Approx. 3.2kgf	
Power	AC100V ~ 240V DC15V 1A AC adapter			
Drive motor	DC brush motor · Stepper motor			
Overload protection/recovery circuit	○	○	○	○
External outlet terminal	○	○	○	○
Escaper S-shape controlling function	○	○	○	○
Yield time	Approx. 0.9sec			
Supported screw diameter	M1.0 ~ M2.0	M2.3 ~ M3.0	M1.0 ~ M2.0	M2.3 ~ M3.0
Supported screw under-head length	Up to 16 mm in length			
Screw capacity	Approx. 40cc			
Accessories and bundled items	Instruction manual, AC adapter, hex wrench, adjusting screwdriver, earth wire			

FM Series

Fixed Quantity Count / External Configuration Type Screw Feeder

Accurately feeds the set number of screws

Supported screw diameter M3.0 ~ M6.0	Supported screw under-head length Longest: 25mm	Capacity About 150cc	Non-ferrous materials: supported
---	--	-------------------------	----------------------------------

*For details, please refer to each product's specifications section.

Fixed-quantity take out FM-36 FME-36
(External Configuration)



⊕ Accurately feeds the number of screws input to counter

Set between 1 and 99. Accurately counts and expels the number you set.

⊕ Stable rail movement without clog

Horizontal rail system prevents screws from clogging or overlapping, achieving stable feed.

⊕ Flexibly supports line changes

Supports screws of varying diameters. Easy installation: simply set into place, and the portable size lets you adapt to line or workpiece changes.

⊕ Long-running operation when combined with screw hopper

FM unit supports 150cc; add screw hopper for additional 400-1600cc stock.

Counter

- Set of 0-99
- Intervals: 0-9999
- Exterior take out signal
- Power outage memory protection feature



Fixed quantity take out with nut support

By special order, we can consider the fixed quantity nut take out model. Please do not hesitate to contact us.



Connect to unit for variable take out quantity (FME-36)

Change the fixed screw feed quantity using a PLC of a variety of manufacturers.

*The PLC interface (NEX-PLC) is exclusively for use with the FME-36.

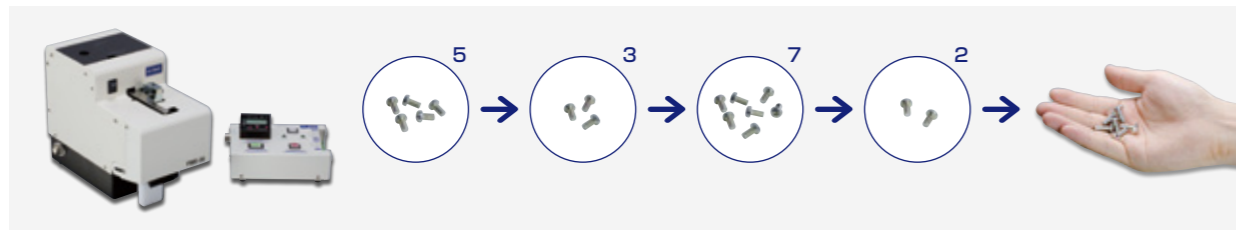

Fixed-quantity take out



FM-36

Fixed-quantity take out with PLC support

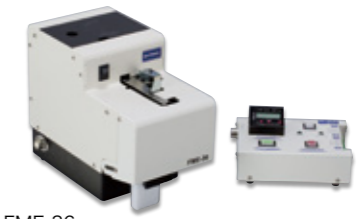

FME-36

Product type

Supported screw diameter (mm)	Main component type		Swap rail set type
	FM Series	FME Series	FM/FME Common across the series
3.0	FM-3630	FME-3630	FR30SET
3.5	FM-3635	FME-3635	FR35SET
4.0	FM-3640	FME-3640	FR40SET
5.0	FM-3650	FME-3650	FR50SET
6.0	FM-3660	FME-3660	FR60SET

Model Diagrams

Full diagrams of each model can be downloaded from our website.

FM-36 Series

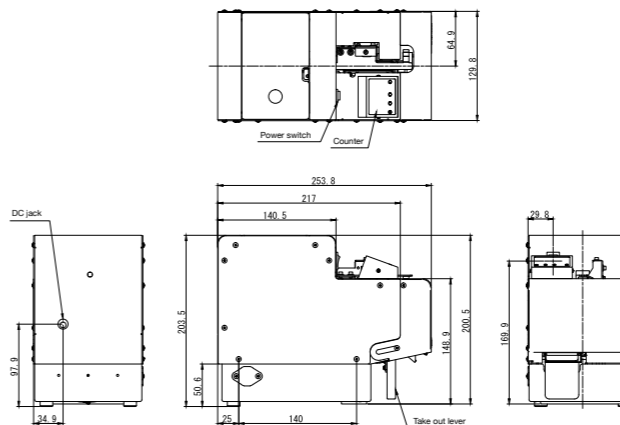

FME-36 Series

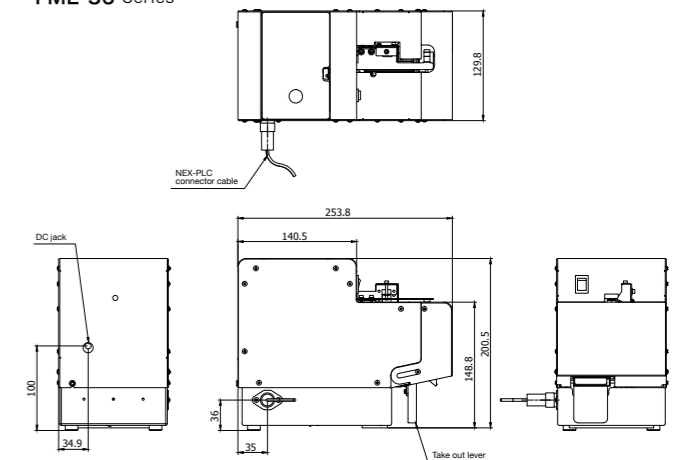

Specifications

Model name	FM-36	FME-36
Main component exterior dimensions	130(W)×254(D)×201(H)	
Main component volume (including the rail)	Approx. 6.0kgf	
Main component power supply	AC100V ~ 240V DC15V 1A AC adapter	
Drive motor	DC brush motor	
Overload protection/recovery circuit	○	
External signal line	○	
Brush overload protection mechanism	○	
Number configuration	99 maximum	127 maximum
Supported screw diameter	M3.0 ~ M6.0	
Supported screw under-head length	Up to 25 mm in length	
Screw capacity	Approx. 150cc	
Accessories and bundled items	Instruction manual, AC adapter, hex wrench, adjusting screwdriver, earth wire	
Extension box exterior dimensions	-	155(W)×113(D)×44(H)
Extension box power supply	-	AC100V ~ 240V DC24V 1.9A AC adapter

*Note that some screw sizes may not support take out of 99 units.

LS / LV / LF Series Large Longneck Screw Feeder

Supports screws and bolts with a diameter of up to M8.0 and an under-head length of 50mm. Ideal for feeding screws and bolts for automotive assembly, construction, and renovation applications.

Supported screw diameter M3.0 ~ M8.0	Supported screw under-head length Longest: 25/50mm	Capacity About 1000/1300cc	For iron screws
---	---	-------------------------------	-----------------

*For details, please refer to each product's specifications section.

Manual	LS25-HM LS-50HM
Robotic	LS25-HR LS-50HR
Fixed-quantity take out	LV25 LV50 LF50



⊕ Large capacity

High-capacity stock: between 1000–1300cc

⊕ We are equipped to support a range of needs

Comes with six patterns that you can select based on the type of workpiece and intended use. (Please refer to the suggested take out patterns)

⊕ Rivet supported

Fixed-quantity alignment of rivet is supported. As there is no need for reorientation of rivet in hand, it greatly improves work efficiency.

Supports screws and bolts of 3.0mm–8.0mm diameters

Achieve a stable, horizontal feed even for large workpieces. Configure up to 999 pieces. No need to check screw quantity each time.



Suggested take out patterns

Manual



LS25-HM / LS50-HM

Robotic

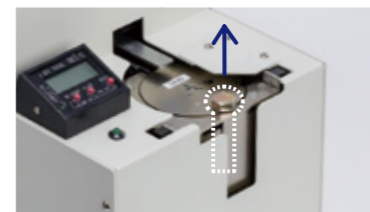

LS25-HR LS-50HR

Lever take out



LV25-S LV50-S

Fixed quantity



LV25-H/ LV50-H

Feed fixed quantity to box



LV25-B/ LV50-B

Feed fixed quantity to rail



LF50

Manual Type



LS25-HM LS-50HM

Robotic Type



LS25-HR LS-50HR

With a Counter



LV25-S LV50-S



LV25-B LV50-B



LV25-H LV50-H



LF50

Product type

Supported screw diameter (mm)	Main component type					
	LS-HM Series		LS-HR Series		LV Series	
	Up to under-head length of 25mm	Up to under-head length of 50mm	Up to under-head length of 25mm	Up to under-head length of 50mm	Up to under-head length of 25mm	Up to under-head length of 50mm
3.0	LS25-HM30	LS50-HM30	LS25-HR30	LS50-HR30	LV25-30	LV50-30
3.5	LS25-HM35	LS50-HM35	LS25-HR35	LS50-HR35	LV25-35	LV50-35
4.0	LS25-HM40	LS50-HM40	LS25-HR40	LS50-HR40	LV25-40	LV50-40
5.0	LS25-HM50	LS50-HM50	LS25-HR50	LS50-HR50	LV25-50	LV50-50
6.0	LS25-HM60	LS50-HM60	LS25-HR60	LS50-HR60	LV25-60	LV50-60
8.0	LS25-HM80	LS50-HM80	LS25-HR80	LS50-HR80	LV25-80	LV50-80

Supported screw diameter (mm)	Main component type
	LF Series
2.0	LF50-20
2.2	LF50-22
2.6	LF50-26

Model Diagrams

Full diagrams of each model can be downloaded from our website.

LS-HM Series

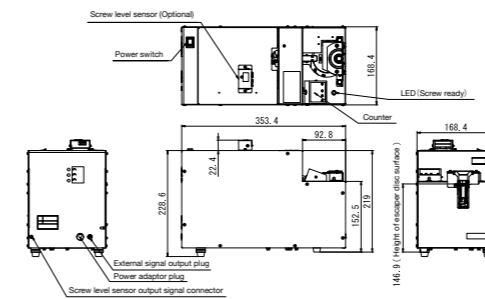

LS-HR Series

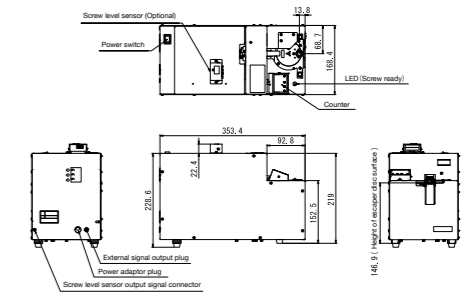

LV Series

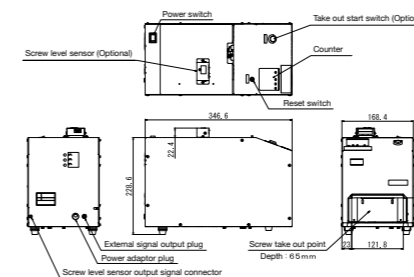

LF Series

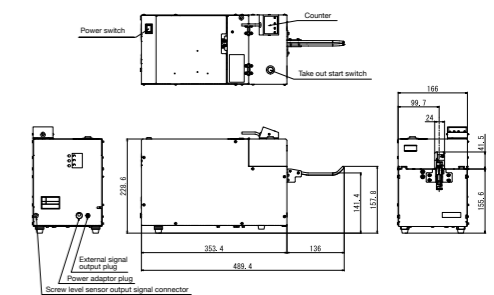

Specifications

Model name	LS25-HM	LS50-HM	LS25-HR	LS50-HR	LV-25	LV-50	LF-50
Exterior dimensions	169(W)×354(D)×229(H)				169(W)×347(D)×229(H)		169(W)×354(D)×229(H) Front rail protruding part : 136mm
Volume (including the rail)	Approx. 15kgf						
Power	AC100V ~ 240V DC15V 1A AC adapter						
Drive motor	DC brushless motor · DC brush motor						
Overload protection/recovery circuit	○	○	○	○	○	○	○
External outlet terminal	○	○	○	○	○	○	○
Safety function	Stopping operation when the cover of stock chamber is open						
Supported screw diameter	M3.0 ~ M8.0		M3.0 ~ M8.0		M3.0 ~ M8.0		φ 2 ~ φ 2.6 (with record)
Supported screw under-head length	Up to 25 mm in length	Up to 50 mm in length	Up to 25 mm in length	Up to 50 mm in length	Up to 25 mm in length	Up to 50 mm in length	Up to 25 mm in length
Screw capacity	Approx. 1300cc	Approx. 1000cc	Approx. 1300cc	Approx. 1000cc	Approx. 1300cc	Approx. 1000cc	Approx. 1000cc
Accessories and bundled items	Instruction manual, AC adapter, hex wrench, adjusting screwdriver, earth wire						

*Please inquire prior to placing an order. You are required to check the work bit you are using.

BS Series Pneumatic Screw Feeder

Pneumatically feeds screws to their destination in an instant

Supported screw diameter M2.0 ~ M6.0	Supported screw under-head length Longest: 12 / 14 / 25 mm	Capacity About 80 ~ 1300cc	For iron screws Non-ferrous materials: supported
---	---	-------------------------------	---

*For details, please refer to each product's specifications section.

Manual	BS-D
Robotic	BS(S) BS(L) BS-P BS-R
Fixed-quantity take out	BS-C

*BS-P irrespective of material / Other models only for iron screw



Use air pressure to convey screws to distant locations

Brings screws right to you using air pressure, dramatically improving work efficiency.

*The default hose is 2.5 meters long, and it requires air tubing to be installed.

Space-saving and high-capacity in one model

Separating the screw feed from take out points allows for a space-saving design.

Four types based on different needs

BS (for manual and robotic) : pneumatically feeds screw in response to an external signal.

BS-R (robotic take out) : sliding unit conveys screws to screwdriver pneumatically, greatly cutting down on yield time.

BS-C (fixed quantity bulk take out) : takes out the quantity set with the counter and allows for removal by simply pulling the lever.

BS-D (fixed quantity single take out) : takes out the number of screws and bolts you set one at a time next to your hand.

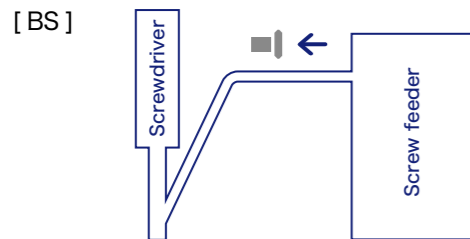

- Screws are pneumatically fed by request through an external signal.
- Screws are fed to the screwdriver's Y pipe with the screw side at the front.
- It is compatible with the screwdriver of screw-tightening robots and manual screw-tightening screwdrivers.

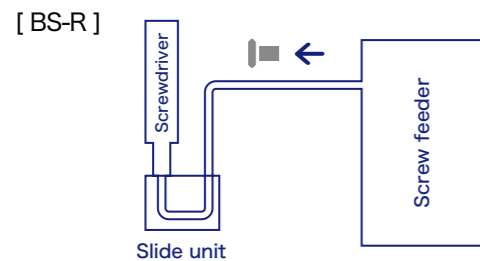

- Screws are pneumatically fed by request through an external signal.
- By placing the screw-feeding part of the slide unit near the screwdriver, it can shorten the time it takes to feed screws to the screwdriver.
- Screws are fed with the screw-head side at the front.
- It is compatible with screw-tightening robots.

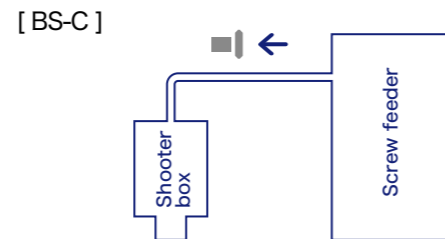

- Screws of fixed quantity are taken out in bulk.
- The screw feeder can be placed outside the work space, saving more space for work.
- With fixed quantity take out, it can contribute to preventing screw tightening being forgotten.

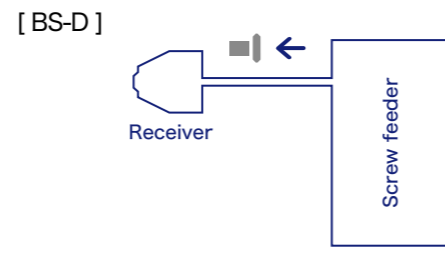

- Fixed quantity screws are taken out one at a time.
- The screw feeder can be placed outside the work space, saving more space for work.
- It feeds the screw next to the hand doing the screw-tightening work.
- With fixed quantity take out, it can contribute to preventing screw tightening being forgotten.

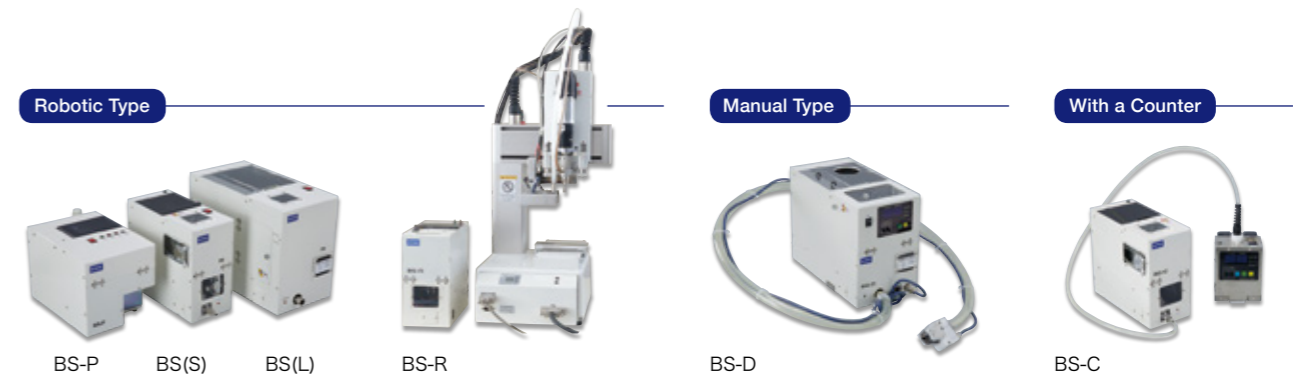

Product type

Supported screw diameter (mm)	Main component type					
	BS Series		BS-R Series	BS-D Series	BS-C Series	
	Scooping chamber capacity: approx. 280cc	Scooping chamber capacity: approx. 1300cc	-	-	Scooping chamber capacity: approx. 280cc	Scooping chamber capacity: approx. 1300cc
2.0	BS-S20	BS-L20	BS-R20	-	BS-CS20	BS-CL20
2.3	BS-S23	BS-L23	BS-R23	-	BS-CS23	BS-CL23
2.6	BS-S26	BS-L26	BS-R26	-	BS-CS26	BS-CL26
3.0	BS-S30	BS-L30	BS-R30	BS-D30	BS-CS30	BS-CL30
3.5	BS-S35	BS-L35	BS-R35	BS-D35	BS-CS35	BS-CL35
4.0	BS-S40	BS-L40	BS-R40	BS-D40	BS-CS40	BS-CL40
5.0	BS-S50	BS-L50	BS-R50	BS-D50	BS-CS50	BS-CL50
6.0	BS-S60	BS-L60	-	BS-D60	BS-CS60	BS-CL60

Model Diagrams

Full diagrams of each model can be downloaded from our website.

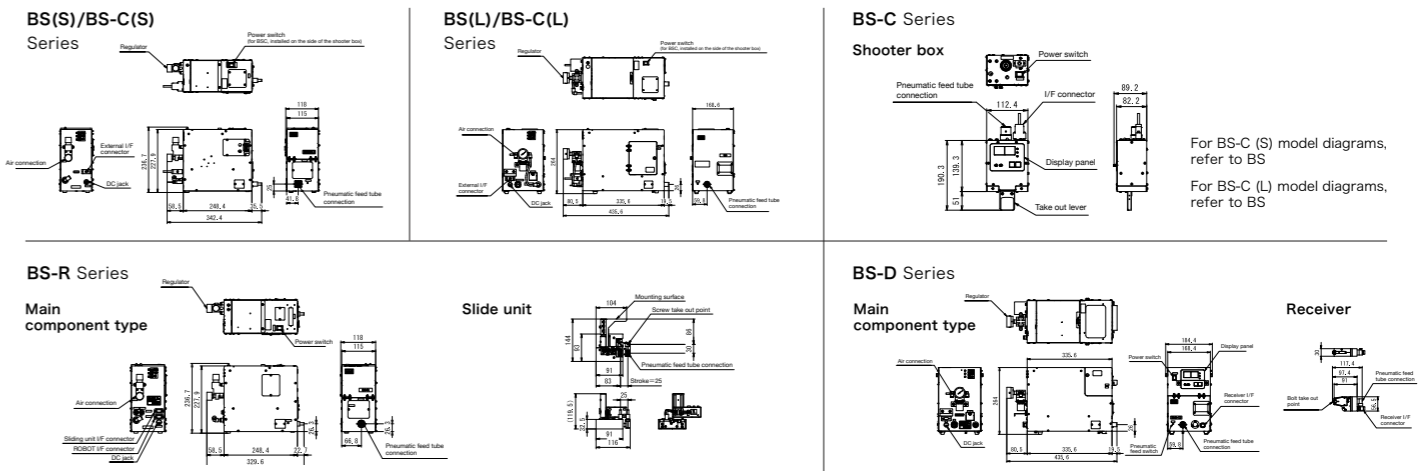

Specifications

Model name	BS-S	BS-L	BS-CS	BS-CL	BS-D	BS-P	BS-R
Exterior dimensions	118(W)×310(D)×237(H)	169(W)×436(D)×270(H)	118(W)×310(D)×237(H)	169(W)×436(D)×270(H)	169(W)×436(D)×270(H)	175(W)×304(D)×186(H)	118(W)×310(D)×237(H)
Volume (including the rail)	Approx. 4kgf	Approx. 10kgf	Approx. 5kgf	Approx. 12kgf	Approx. 12kgf	Approx. 4kgf	Approx. 4.6kgf
Power	AC100V ~ 240V DC15V 1A AC adapter						
Air	0.5MPa MAX 400L / min						
Drive motor	DC brushless motor						
Pneumatic screw feeding direction							
Overload protection/recovery circuit	○	○	○	○	○	○	○
External interface	○ (D-SUB 9pin)	○ (D-SUB 9pin)	-	-	-	○ (D-SUB 9pin)	○ (D-SUB 9pin)
Yield time	M6X25/3M Approx. 2 seconds by tube					Approx. 1.2sec	Approx. 1.5sec
Supported screw diameter	M2.0 ~ M6.0				M3.0 ~ M6.0	M1.0 ~ M3.0	M2.0 ~ M5.0
Supported screw under-head length	Up to 25 mm in length				Up to 10 ~ 25mm in length	Up to 12 mm in length	Up to 14 mm in length
Supported total length of screw	Length / head diameter = 1.3 or more						
Screw capacity	Approx. 280cc	Approx. 1300cc	Approx. 280cc	Approx. 1300cc	Approx. 1300cc	Approx. 80cc	Approx. 280cc
Accessories and bundled items	Instruction manual, AC adapter, hex wrench, adjusting screwdriver, earth wire, Pneumatic feed tube (2.5M)						
Accompanying unit	-	-	Shooter box Form : 113(W)×82(D)×140(H) Capacity: Approx. 20 for M6X25		Receiver Form : 30(W)×52(D)×120(H)		Slide unit Form : 116(W)×144(D)×120(H)

*Please inquire prior to placing an order.

Enables Long-running Screw Feeding

Screw Hopper

A sensor detects a screw stock to automatically feed the optimal amount of screws. Use this to make operation management easier.

Supported screw diameter M1.0 ~ M6.0	Supported screw length (total) Longest: 18 / 25 mm	Capacity About 400 ~ 1600cc	For iron screws Non-ferrous materials: supported
---	---	--------------------------------	---

*For details, please refer to each product's specifications section.



SR-80 / NJ-80 Rear-attaching Impeller Style Model

- Easy installation—simply line up next to the screw feeder. It will not take up space on the upper surface.
- Super compact model fits anywhere yet has room for a screw stock of 800cc.
- Use the timer to set the impeller operation time.

Product type

SR-80 model Model number	Supported screw feeder	NJ-80 model Model number	Supported screw feeder
SR-80	NSB / NSR / NSBI / NSRI / NSRI-B	NJ-80	NJ / NJR
		NJ-80F	FM-36 / FME-36

Stock capacity based on the diameter and length of the screw for 800cc:
M2.3x5, approx. 20,000; M3.0x6, approx. 5,600



T-510 Conveyor Style, Surface Mounting Model

- Easy installation—simply align on top of the screw feeder.
- Does not take up floor space; allows you to add more stock vertically.
- Use the timer to set conveyor belt operation time.

Product type

T-510 model Model number	Supported screw feeder
T-510S	NSB / NSR / NSBI / NSRI / NSRI-B
T-510J	NJ / NJR
T-510F	FM-36 / FME-36

Stock capacity based on the diameter and length of the screw for 400cc:
M2.3 x5, approx. 10,000; M3.0 x6, approx. 2,800

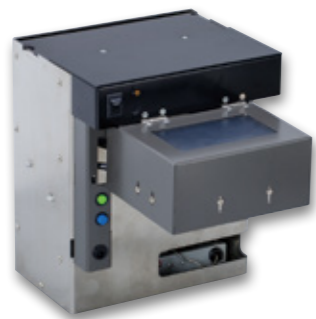

RHP-160 Side and Rear Attaching High-Capacity Impeller Style Model

- Easy installation—simply line up next to the screw feeder.
- Supports a screw stock of approximately 1600cc.
- Use the timer to set the impeller operation time.

Product type

RHP-160 model Model number	Supported screw feeder
RHP-160J	NJ / NJR
RHP-160F	FM-36 / FME-36
RHP-160M	OM-26M / OM-26R / OM-26RB



MHP-80 Magnetic Style, Rear Attaching Model

- Easy installation—simply line up next to the screw feeder. Even supports long screws.
- Magnets are used to feed and convey screws.
- Use the timer to set the magnet operation time.

Product type

MHP-80 model Model number	Supported screw feeder
MHP-80S	NSB / NSR / NSBI / NSRI / NSRI-B
MHP-80J	NJ / NJR
MHP-80F	FM-36 / FME-36
MHP-80M	OM-26M / OM-26R / OM-26RB

Model Diagrams

Full diagrams of each model can be downloaded from our website.

SR-80 Model

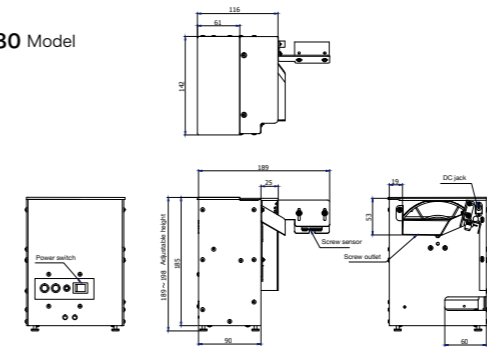

RHP Model

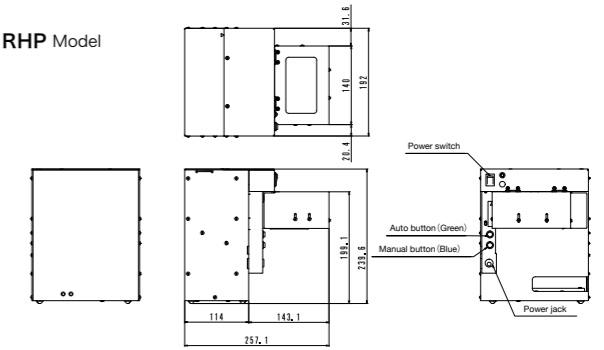

NJ-80 Model

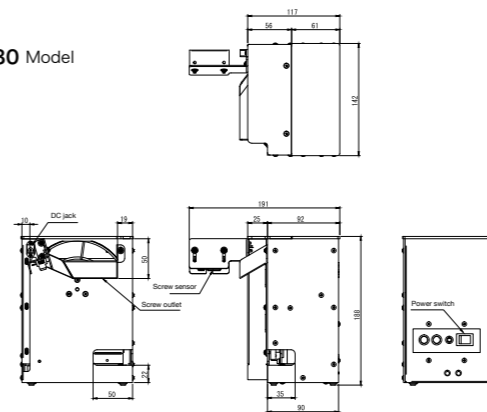

MHP Model (MHP-80M)

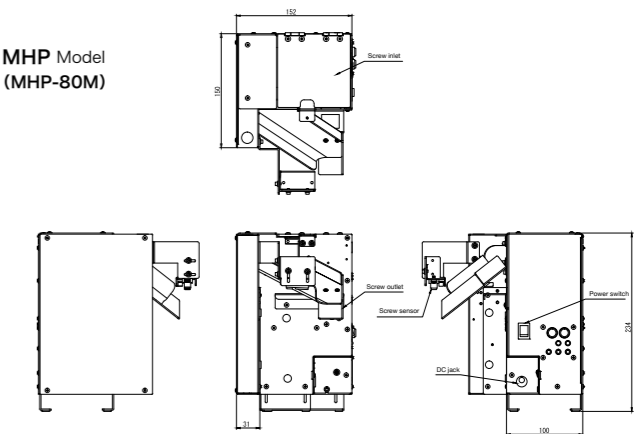

T510 Model

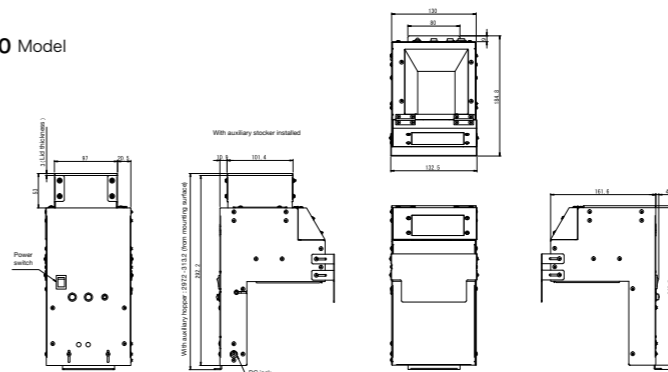

Specifications

Model name	NJ-80	SR-80	T-510	RHP-160	MHP-80
Exterior dimensions	142(W)×191(D)×188(H)	142(W)×191(D)×189~198(H)	130(W)×171(D)×245(H) With auxiliary stocker installed 295(H)	192(W)×237(D)×240(H)	156(W)×150(D)×212(H)
Volume (including the rail)	Approx. 2.9kgf		Approx. 3.1kgf	Approx. 5.5kgf	Approx. 2.9kgf
Power	AC100V DC12V 0.5A AC adapter			AC100V ~ 240V DC15V 1A AC adapter	
Drive motor	DC brush motor				
External signal line (remaining quantity sensor)	-	-	○	-	○ (Optional)
Safety function	-	-	-	Stopping operation when the cover of stock chamber is open	-
Supported screw materials	-		-	-	Iron only
Supported screw diameter	M2.0 ~ M6.0		M1.0 ~ M6.0	M2.0 ~ M6.0	
Supported total length of screw	Up to 18 mm in length		Up to 25 mm in length		
Screw capacity	Approx. 800cc		Main component : Approx. 400cc auxiliary stocker : Approx. 400cc	Approx. 1600cc	Approx. 800cc
Accessories and bundled items	Instruction manual, AC adapter, Screw splash-proof cover / mounting plate, attaching screws (only for T-510F)		Instruction manual, auxiliary stocker, AC adapter, hex wrench, Screw (nominal length 2.6 x 5), External signal line / mounting plate, attaching screws (only for T-510F)	Instruction manual, AC adapter, hex wrench / mounting plate, attaching screws (only for RHP-160F)	Instruction manual, AC adapter, Screw splash-proof cover, adjusting screwdriver / mounting plate, attaching screws (only for MHP-80F)

FAQ

Q Can I increase screw capacity for the screw feeder?	You can add a screw hopper to add capacity of 400–1600cc.
Q Self-tapping screws are not working as intended. Why?	One possible cause is that M3.5 tolerance screws are intermingled with M3.0 tapping screws. If handling workpieces with large differences in screw tolerance, select a product based on the maximum screw and bolt diameter.
Q I want to use a hexagon socket head cap bolt.	If you are considering a hexagon socket head cap bolt, please inquire at our dealer before placing an order.
Q Can I have model diagrams?	They can be downloaded from our website.
Q Do you support special screw and bolt shapes?	If you are considering a device for a specialized screw or bolt, please print out the Special Order Form from our website, complete it, and submit it to one of our dealers.
Q Can I have extra parts for maintenance?	To purchase extra parts, please contact the dealer where you purchased the product.
Q How can I fix a feeder for a robotic device?	This is described in the product manual available on our website.
Q I want to know more about options.	Please refer to our website.

Signals obtained from signal line

- Manual models : Signal of the screw take out can be obtained.
- Robotic models : Signal of whether there is a screw in the screw take out point can be obtained.
- Fixed quantity take out models : Signal of feed completion for set number of screws can be obtained.

For customers seeking repairs



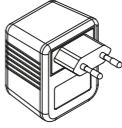

Print out a repair request form from our website, complete it, and submit it to the dealer where you purchased the product. Include the repair request form with your item to be repaired. If you do not have a printer, please include the details indicated on the right on a piece of paper.

- Product name
- Serial number (on reverse)
- Company name, address, contact person name and department, telephone number, fax number
- Problem (in detail)
- Context in which it is used (type of screws, etc.)

Automatic screw feeder AC adapter plug formats

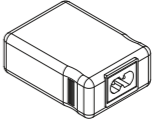
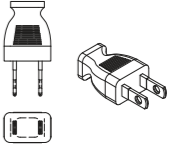
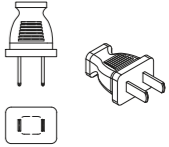
Model	DC voltage	Adapter model	AC cord types	(Representative) countries supported	Selection method	Adapter plug shape
Screw hopper	DC12V	AD-1200 500DJ	100V adapter	Japan	Flat 2-pin with holes	PSE (Japan) certified power adapter (100V AC) 
		YL41-12000 500D	230 V adapter	EU countries other	Round 2-pin	CE (EU) certified power adapter (230V AC) 

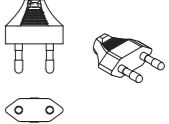
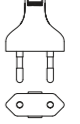
*For 12V DC, adapter and AC cord are one unit. Customers are required to make other preparations themselves.

Model	DC voltage	Adapter model	AC cord types	AC cord format	(Representative) countries supported	Selection method	Adapter plug shape	Power cord
All models other than screw hopper	DC15V	U I 315 -15	PSE cord	K427B1 VK183 BB-P-00	Japan Mexico Brazil other	Flat 2-pin with holes		PSE (Japan) certified (100V AC) 
			CCC cord	K207D1 H4193 BB-3C	China Thailand Taiwan Malaysia Vietnam US Brazil other	Flat 2-pin without holes		CCC (China) certified (220V AC) 
			KC cord	K427B1 VK183 BB-P-00	Korea	Round 2-pin		KC (Korea) certified (220V AC) 
			CE cord	K13071 H4183 BB-M	EU countries Argentina Indonesia India Vietnam other	Round 2-pin		CE (EU) certified (250V AC) 

*For 15V DC, adapter and AC are separate.

im Vertrieb von:

Schäffner GmbH
Geschäftsbereich Tools & Service
73430 Aalen
Tel.: 07361/969659
post@schaeffner-tools.de
www.schaeffner-tools.de