

Steckschlüssel und Bits für Industriewerkzeuge Saltus / Rotation



Große Bandbreite an Steckschlüsseln und Bits von Saltus für den Industrieinsatz

Leistungsvergleiche zeigen, dass Steckschlüssel und Bits aus dem Saltus-Programm die erste Wahl auf dem Markt sind. Ob ein kleiner 4-mm-Halfmoonbit zur Montage hochmoderner Smartphones oder eine 2½"-Steckschlüssel zur Herstellung und Wartung von Windenergieanlagen, bei Atlas Copco findet sich alles. Darüber hinaus bieten wir auch ein umfassendes Sortiment an Steckschlüsseln und Bits für die Automobilproduktion an, die sich durch eine hohe Robustheit und Langlebigkeit auszeichnen.

Wenn Sie also Steckschlüssel und Bits suchen, dann sind Sie bei uns genau richtig. Auf diesen Seiten werden über 2400 hochwertige Saltus-Produkte vorgestellt. Sie wurden entwickelt, um Ihre Montagevorgänge zu optimieren und Ihre Produktivität zu steigern – und liegen für den Versand direkt ab Lager bereit.

Neuigkeiten im vorliegenden Katalog

- Alle benötigten Informationen an einem Ort und ein noch umfassenderes Sortiment.
- ROTACTION: Das Thema Sicherheit der Anwender spielt in den Werken unserer Kunden eine immer größere Rolle. Um den Arbeitsschutz für die Anwender zu verbessern, haben wir unser Angebot an ROTACTION-Produkten nahezu verdreifacht.
- Erweitertes Angebot an Steckschlüsseln mit Führung und Bits für Druckluftwerkzeuge.
- Erweitertes Angebot an Bits für Montagewerkzeuge im unteren Drehmomentbereich.
- Spezielle Steckschlüssel für Radmontagesysteme.
- Drehmomentempfehlungen für die einzelnen Steckschlüssel und Bits (siehe grundlegende Produktinformationen am Ende des Katalogs).

Falls Sie in diesem Standardkatalog das Gesuchte nicht finden, entwickeln wir gern eine auf Ihre Bedürfnisse abgestimmte Lösung für Sie.



Atlas Copco



Lieferung aus unserem Werk in Schweden – hohe Qualität zum Termin

Für die Produktion von Steckschlüsseln und Bits aus dem Saltus-Programm verfügt Atlas Copco über ein eigenes Werk im schwedischen Tierp. Viele Arbeitsgänge wie die Wärmebehandlung werden hier in Eigenregie ausgeführt, sodass wir die volle Kontrolle über unsere Produktion ausüben und eine hohe Qualität unserer Produkte garantieren können. Durch diese Kontrolle sind wir auch in der Lage, unsere Lieferversprechen einzuhalten.

Mehrwert durch maßgeschneiderte Lösungen
In unserem Kompetenzzentrum ist eine eigene Abteilung für den technischen Kundendienst, die Produktentwicklung und die Produktionssteuerung zuständig.

Sollten Sie im vorliegenden Katalog nicht das Passende für Ihre Montageanforderungen finden, dann entwickelt diese Abteilung in enger Zusammenarbeit mit Ihnen eine optimale, perfekt an Ihre Bedürfnisse angepasste Lösung.

Mit ihren reichhaltigen Erfahrungen in der Entwicklung von Sonderwerkzeugen für schwierige oder ungewöhnliche Montageanwendungen können unsere Fachleute für Sie eine Lösung erarbeiten, die nicht nur Ihre Anforderungen erfüllt, sondern auch zur Optimierung Ihrer Produktion und damit zur Wertschöpfung Ihres Unternehmens beiträgt.

Entwicklung der Lösungen für die Zukunft
Darüber hinaus arbeiten unsere Fachleute für Steckschlüssel und Bits kontinuierlich an der Entwicklung neuer, innovativer Produkte und Lösungen, um die Anforderungen für zukünftige Schraubvorgänge zu erfüllen.

Teilen Sie uns mit, welche Herausforderungen an Ihren Montagelinien bestehen – wenden Sie sich mit Ihrer Anfrage an Ihren Vertreter von Atlas Copco vor Ort.





SALTUS 4027016533-1979

SALTUS 4027016534-10mm AK

SALTUS 4027016534-10mm AK

SALTUS 4027016534-10mm AK

SALTUS 4027016532-13mm AK

4027016534-10mm AK

A close-up photograph of a yellow power tool handle. The handle is cylindrical and has a textured grip. At the bottom left, there is a small circular opening. The handle is connected to a silver metal shaft. The background is blurred, showing other tools and a white surface. A central blue circle contains the text 'Integriertes ROTACTION-Konzept'. Three white circles with black text are connected to the central circle by thin white lines. The labels point to the bottom opening, the main handle body, and the silver shaft.

Integriertes
ROTACTION-
Konzept

Steck-
schlüssel

Steckschlüssel
Abdeckung

Verläng-
erung

ROTACTION – die professionelle Lösung von Atlas Copco für sichere Schraubvorgänge

Mit dem hochmodernen und wegweisenden ROTACTION-Konzept reagiert Atlas Copco auf die wachsende Nachfrage aus dem Montagebereich nach Werkzeugen, die den Arbeitsschutz verbessern und keine Spuren auf dem Werkstück hinterlassen.

Die Kombination von frei drehenden Hülsen und neu entwickelte Abdeckungen für die Anschlüsse „Werkzeug-zu-Steckschlüssel“ und „Verlängerung-zu-Steckschlüssel“ verbessert die Bediener-sicherheit erheblich.

ROTACTION ist für viele der elektrischen Montagewerkzeuge von Atlas Copco erhältlich.

Abgedeckte ROTACTION-Steckschlüssel sorgen für:

- Besseren Arbeitsschutz
- Geringere Gefahr von Kratzern und Schäden an lackierten Oberflächen
- Geringe Reibung
- Hohe Abriebfestigkeit
- Gute Zugänglichkeit der Verbindungen durch geringen Außendurchmesser

Das ROTACTION-Sortiment umfasst:

- Verschiedene Steckschlüssel, Bithalter und Steckschlüsseinsätze mit neuen, frei drehenden Steckschlüssel-Abdeckungen
- Verschiedene Verlängerungen mit rotierenden Steckschlüssel-Abdeckungen
- Steckschlüsselabdeckungen zum Überbrücken von Lücken zwischen Verlängerung und Steckschlüssel (siehe S. 137)
- Edelstahl-Schutzringe zum Schließen der Lücke zwischen Winkelkopfwerkzeugen und Steckschlüssel bzw. Verlängerung (siehe S. 137)

Zusätzlich zu der breiten Palette von Standardprodukten können auch kundenspezifische Lösungen verwirklicht werden.



Edelstahl-
Schutzringe

4027-0000-00

Inhalt

Wing-shank Ø 4 mm Antrieb	8
Halfmoon Ø 4 mm Antrieb	11
Antrieb 1/4", Sechskant, Form C	16
Antrieb 1/4", Sechskant, Form E	22
Antrieb 5/16", Sechskant, Form C	35
Antrieb 7/16", Sechskant, Form E	38
Vierkantantrieb 1/4"	44
Vierkantantrieb 3/8"	55
Vierkantantrieb 1/2"	81
Vierkantantrieb 5/8"	106
Vierkantantrieb 3/4"	108
Vierkantantrieb 1"	119
Vierkantantrieb 1,1/2"	125
Vierkantantrieb 2,1/2"	127
Stehbolzen-Einziehwerkzeug	129
Stift- und O-Ring-Sets	132
Steckschlüssel Abeckungen und Schutzringe für ROTACTION...	133
Umfassendes Angebot an Hold-and-Drive-Werkzeugen (HAD) und Zubehör	138
Grundlegende Produktinformationen	140



Motor Vehicle Industry and
million vehicles produced
benchmark for many other
continuous need for new
electric and hybrid cars
new lightweight materials

Wing-shank Ø 4 mm Antrieb





Wing-shank Ø 4 mm Antrieb 8

Bits, für Innensechskant-Schrauben.....	9
Bits, für Torx®-Schrauben	9
Bits, für TorxPlus®-Schrauben.....	9
Bits, für Phillips-Schrauben	10
Bits, für Pozidriv-Schrauben.....	10
Bits, für Schlitz-Schrauben	10
Bithalter, Sechskantantrieb Form E, für Bits mit Wing-shank Ø 4 mm.....	10



Bits, für Innensechskant-Schrauben



		Länge L mm	max. Drehmoment Nm	Bestell- nummer
mm	mm			
Wing-shank Ø 4	1,5	60	0,67	4023 0002 60
Wing-shank Ø 4	2	60	1,6	4023 0002 61
Wing-shank Ø 4	2,5	60	3,1	4023 0002 62
Wing-shank Ø 4	3	60	5,3	4023 0002 63



Bits, für Torx®-Schrauben



		Länge L mm	max. Drehmoment Nm	Bestell- nummer
mm				
Wing-shank Ø 4	T1	40	0,07	4023 0002 52
Wing-shank Ø 4	T2	40	0,1	4023 0002 53
Wing-shank Ø 4	T3	40	0,18	4023 0002 54
Wing-shank Ø 4	T4	40	0,26	4023 0001 90
Wing-shank Ø 4	T5	60	0,36	4023 0001 91
Wing-shank Ø 4	T6	60	0,64	4023 0001 92
Wing-shank Ø 4	T8	60	1,8	4023 0001 93
Wing-shank Ø 4	T10	60	3,2	4023 0001 94

Bits, für TorxPlus®-Schrauben





		Länge L mm	max. Drehmoment Nm	Bestell- nummer
mm				
Wing-shank Ø 4	4IP	60	0,31	4023 0002 10
Wing-shank Ø 4	5IP	60	0,43	4023 0002 11
Wing-shank Ø 4	6IP	60	0,78	4023 0002 12
Wing-shank Ø 4	8IP	60	2,2	4023 0002 13
Wing-shank Ø 4	10IP	60	3,8	4023 0002 14

Torx®, Torx Plus® sind eingetragene Warenzeichen von Acument Intellectual Properties, LLC.



Bits, für Phillips-Schrauben



		Länge L mm	max. Drehmoment Nm	Bestell- nummer
mm				
Wing-shank Ø 4	PH00	40	0,4	4023 0002 56
Wing-shank Ø 4	PH0	40	0,7	4023 0002 57
Wing-shank Ø 4	PH1	40	2,7	4023 0002 58
Wing-shank Ø 4	PH2	40	7,2	4023 0002 59



Bits, für Pozidriv-Schrauben



		Länge L mm	max. Drehmoment Nm	Bestell- nummer
mm				
Wing-shank Ø 4	PZ0	60	0,7	4023 0002 03
Wing-shank Ø 4	PZ1	60	2,7	4023 0002 04
Wing-shank Ø 4	PZ2	60	7,2	4023 0002 55

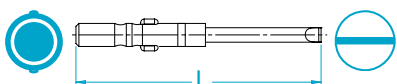

Bits, für Schlitz-Schrauben

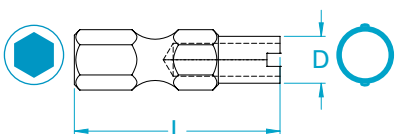

		Länge L mm	max. Drehmoment Nm	Bestell- nummer
mm	mm			
Wing-shank Ø 4	0,3x2	40	0,25	4023 1327 03
Wing-shank Ø 4	0,3x2,5	40	0,32	4023 1327 04

Bithalter, Sechskantantrieb Form E, für Bits mit Wing-shank Ø 4 mm



		Ø Abtrieb D mm	Länge L mm	Gewicht g	Bestell- nummer
Zoll	mm				
1/4	Wing-shank Ø 4	5,7	25	4	4220 0105 00

Halfmoon Ø 4 mm Antrieb

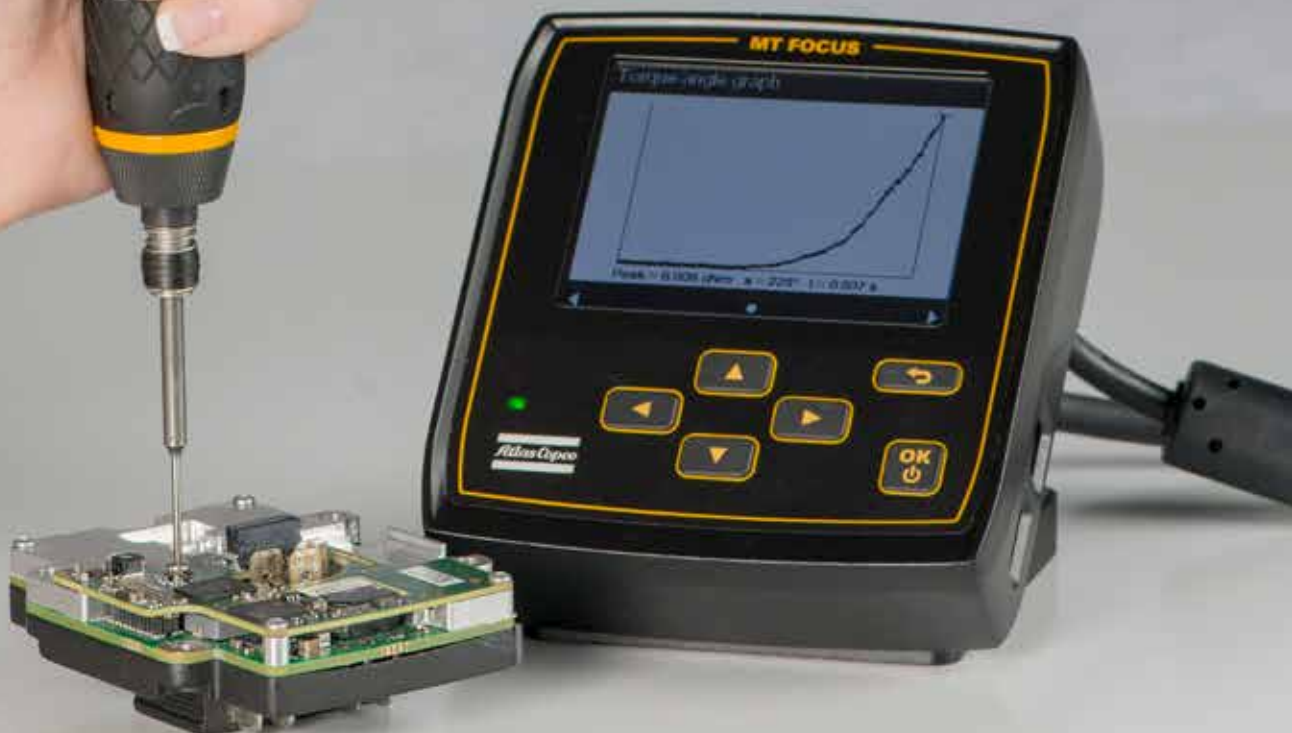

Halfmoon Ø 4 mm Antrieb 11

Bits, für Innensechskant-Schrauben.....	12
vcBits, für Torx®-Schrauben	12
Bits, für TorxPlus®-Schrauben.....	13
Bits, für Phillips-Schrauben	13
Bits, für Pozidriv-Schrauben.....	14
Bits, für Schlitz-Schrauben	14
Steckschlüssel, Sechskant.....	14
Bithalter, Halfmoon Ø 4 mm Antrieb, für Bits mit Sechskant Form C, mit Magnet	15



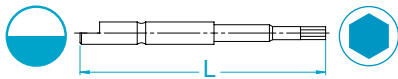

Bits, für Innensechskant-Schrauben



		Länge L mm	max. Drehmoment Nm	Bestell- nummer
mm	mm			
Halfmoon Ø 4	1,5	44	0,67	4023 0002 41
Halfmoon Ø 4	2	44	1,6	4023 0002 42
Halfmoon Ø 4	2,5	44	3,1	4023 0002 43
Halfmoon Ø 4	3	44	5,3	4023 0002 44

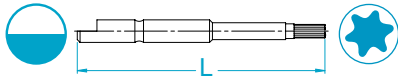

Bits, für Torx®-Schrauben



		Länge L mm	max. Drehmoment Nm	Bestell- nummer
mm				
Halfmoon Ø 4	T1	44	0,07	4023 0002 32
Halfmoon Ø 4	T2	44	0,1	4023 0001 06
Halfmoon Ø 4	T3	44	0,18	4023 0001 08
Halfmoon Ø 4	T3	64	0,18	4023 0001 09
Halfmoon Ø 4	T4	44	0,26	4023 0001 20
Halfmoon Ø 4	T4	64	0,26	4023 0001 21
Halfmoon Ø 4	T5	44	0,36	4023 0001 22
Halfmoon Ø 4	T5	64	0,36	4023 0001 23
Halfmoon Ø 4	T6	44	0,64	4023 0001 24
Halfmoon Ø 4	T6	64	0,64	4023 0001 25
Halfmoon Ø 4	T8	44	1,8	4023 0001 26
Halfmoon Ø 4	T8	64	1,8	4023 0001 27
Halfmoon Ø 4	T10	44	3,2	4023 0001 28
Halfmoon Ø 4	T10	64	3,2	4023 0001 29

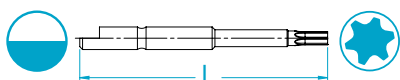

Bits, für TorxPlus®-Schrauben



		Länge L mm	max. Drehmoment Nm	Bestell- nummer
mm				
Halfmoon Ø 4	2IP	44	0,11	4023 0002 35
Halfmoon Ø 4	3IP	44	0,2	4023 0002 36
Halfmoon Ø 4	4IP	44	0,31	4023 0001 30
Halfmoon Ø 4	4IP	64	0,31	4023 0001 31
Halfmoon Ø 4	5IP	44	0,43	4023 0001 32
Halfmoon Ø 4	5IP	64	0,43	4023 0001 33
Halfmoon Ø 4	6IP	44	0,78	4023 0001 34
Halfmoon Ø 4	6IP	64	0,78	4023 0001 35
Halfmoon Ø 4	8IP	44	2,2	4023 0001 36
Halfmoon Ø 4	8IP	64	2,2	4023 0001 37
Halfmoon Ø 4	10IP	44	3,8	4023 0001 38
Halfmoon Ø 4	10IP	64	3,8	4023 0001 39

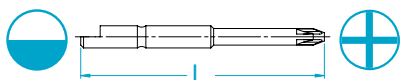

Bits, für Phillips-Schrauben



		Länge L mm	max. Drehmoment Nm	Bestell- nummer
mm				
Halfmoon Ø 4	PH00	44	0,4	4023 0001 12
Halfmoon Ø 4	PH00	64	0,4	4023 0001 13
Halfmoon Ø 4	PH0	44	0,7	4023 0001 14
Halfmoon Ø 4	PH0	64	0,7	4023 0001 15
Halfmoon Ø 4	PH1	44	2,7	4023 0001 16
Halfmoon Ø 4	PH1	64	2,7	4023 0001 17
Halfmoon Ø 4	PH1	90	2,7	4023 0001 18
Halfmoon Ø 4	PH2	44	7,2	4023 0002 30
Halfmoon Ø 4	PH2	64	7,2	4023 0002 31

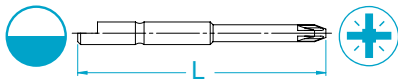

Bits, für Pozidriv-Schrauben



		Länge L mm	max. Drehmoment Nm	Bestell- nummer
mm				
Halfmoon Ø 4	PZ0	44	0,7	4023 0002 26
Halfmoon Ø 4	PZ0	64	0,7	4023 0002 27
Halfmoon Ø 4	PZ1	44	2,7	4023 0002 28
Halfmoon Ø 4	PZ1	64	2,7	4023 0002 29

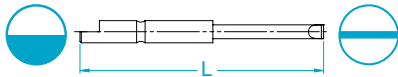

Bits, für Schlitz-Schrauben



		Länge L mm	max. Drehmoment Nm	Bestell- nummer
mm	mm			
Halfmoon Ø 4	0,3x2	44	0,25	4023 0002 37
Halfmoon Ø 4	0,3x2,5	44	0,32	4023 0002 38
Halfmoon Ø 4	0,4x3	44	0,56	4023 0002 39
Halfmoon Ø 4	0,5x4	44	0,77	4023 0002 40

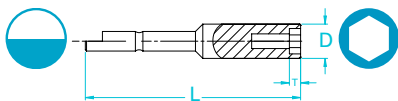

Steckschlüssel, Sechskant

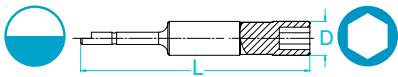

		Ø Abtrieb D mm	Länge L mm	Tiefe T mm	Gewicht g	max. Drehmoment Nm	Bestell- nummer
mm	mm						
Halfmoon Ø 4	2,3	4	44	2	1	2,5	4023 0002 45
Halfmoon Ø 4	2,5	4	44	2	2	3	4023 0002 46
Halfmoon Ø 4	3	5	44	2	4	4,4	4023 0002 47
Halfmoon Ø 4	4	7	44	2	7	7,3	4023 0002 48
Halfmoon Ø 4	4,5	7	44	2,3	6	8,8	4023 0002 49
Halfmoon Ø 4	5	8	44	2,6	8	11	4023 0002 50
Halfmoon Ø 4	5,5	8	44	3	7	12	4023 0002 51

Bithalter, Halfmoon Ø 4 mm Antrieb, für Bits mit Sechskant Form C, mit Magnet



		Ø Abtrieb D mm	Länge L mm	Gewicht g	Bestell- nummer
mm	Zoll				
Halfmoon Ø 4	1/4	11,1	75	32	4023 0002 15

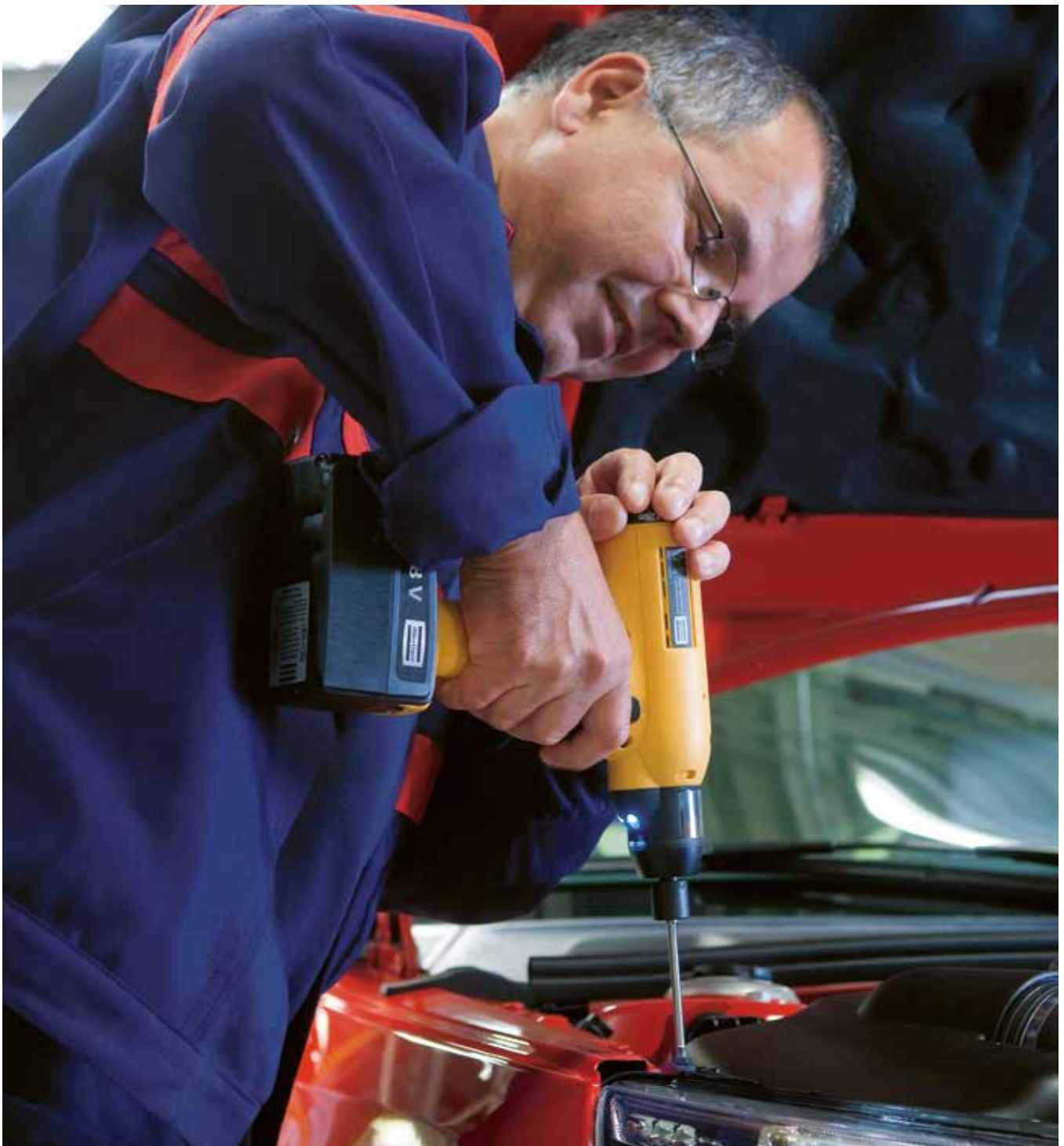



1/4" Sechskant Antrieb, Form C

1/4" Sechskant Antrieb, Form C 16

Bits, für Innensechskant-Schrauben.....	17
Bits, für Torx®-Schrauben	17
Bits, für Torx®-Schrauben (manipulationssicher)	17
Bits, für TorxPlus®-Schrauben.....	18
Bits, für Phillips-Schrauben.....	18
Bits, für Pozidriv-Schrauben.....	18
Bithalter, Halfmoon Ø 4 mm Antrieb, für Bits mit Sechskant Form C mit Magnet	19
Bithalter, Sechskantantrieb Form E, für Bits mit Sechskant Form C	19
Bithalter, Sechskantantrieb Form E, für Bits mit Sechskant Form C mit Magnet..	19
Bithalter, Sechskantantrieb Form E, für Bits mit Sechskant Form C mit Magnet, ROTACTION.....	20
Bithalter, Vierkantantrieb, für Bits mit Sechskant Form C	20
Bithalter, Vierkantantrieb, für Bits mit Sechskant Form C, ROTACTION.....	20
Bithalter, Vierkantantrieb, für Bits mit Sechskant Form C mit Magnet.....	21
Bithalter, Vierkantantrieb, für Bits mit Sechskant Form C mit Magnet, ROTACTION.....	21
Schnellwechselfutter, Vierkantantrieb, für Bits mit Sechskant Form C.....	21

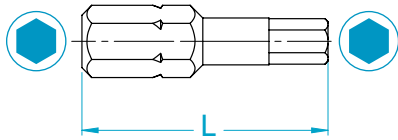
Bits, für Innensechskant-Schrauben



		Länge L mm	max. Drehmoment Nm	Bestell- nummer
Zoll	mm			
1/4	2	25,4	1,6	4023 1318 00
1/4	2,5	25,4	3,1	4023 1319 00
1/4	3	25,4	5,3	4023 0819 00
1/4	4	25,4	13	4023 1320 00
1/4	5	25,4	25	4023 0820 00
1/4	6	25,4	43	4023 0821 00
1/4	7	25,4	49	4023 1430 00
1/4	8	25,4	49	4023 0905 00

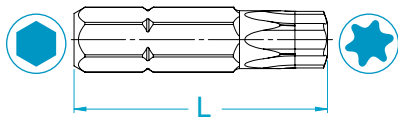

Bits, für Torx®-Schrauben



		Länge L mm	max. Drehmoment Nm	Bestell- nummer
Zoll				
1/4	T6	25,4	0,64	4023 0001 60
1/4	T8	25,4	1,8	4023 1329 00
1/4	T9	25,4	2,4	4023 1330 00
1/4	T10	25,4	3,2	4023 1321 00
1/4	T15	25,4	5,4	4023 1331 00
1/4	T20	25,4	8,9	4023 1322 00
1/4	T25	25,4	13	4023 1332 00
1/4	T27	25,4	19	4023 1333 00
1/4	T30	25,4	26	4023 1323 00
1/4	T40	25,4	46	4023 1334 00

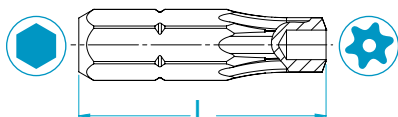

Bits, für Torx®-Schrauben (manipulationssicher)



		Länge L mm	max. Drehmoment Nm	Bestell- nummer
Zoll				
1/4	T30H	25,4	22	4027 1025 30

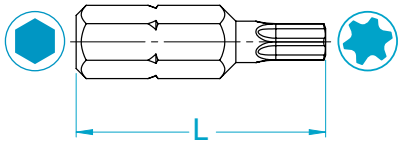

Bits, für TorxPlus®-Schrauben



		Länge L mm	max. Drehmoment Nm	Bestell- nummer
Zoll				
1/4	6IP	25,4	0,78	4023 0001 70
1/4	8IP	25,4	2,2	4023 0001 74
1/4	10IP	25,4	3,8	4023 0001 78

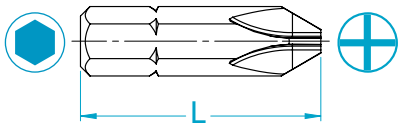

Bits, für Phillips-Schrauben



		Länge L mm	max. Drehmoment Nm	Bestell- nummer
Zoll				
1/4	PH0	25,4	0,7	4023 1326 00
1/4	PH1	25,4	2,7	4023 0696 01
1/4	PH2	25,4	7,2	4023 0697 01
1/4	PH3	25,4	22	4023 0698 01

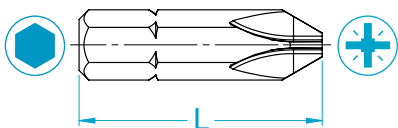

Bits, für Pozidriv-Schrauben



		Länge L mm	max. Drehmoment Nm	Bestell- nummer
Zoll				
1/4	PZ1	25,4	2,7	4023 1101 11
1/4	PZ2	25,4	7,2	4023 1101 12
1/4	PZ3	25,4	22	4023 1101 13

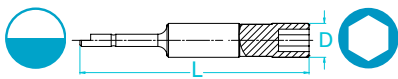

Bithalter, Halfmoon Ø 4 mm Antrieb, für Bits mit Sechskant Form C mit Magnet



		Ø Abtrieb D mm	Länge L mm	Gewicht g	Bestell- nummer
mm	Zoll				
Halfmoon Ø 4	1/4	11,1	75	32	4023 0002 15

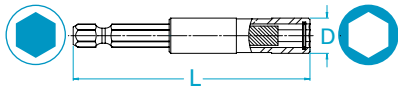

Bithalter, Sechskantantrieb Form E, für Bits mit Sechskant Form C



		Ø Abtrieb D mm	Länge L mm	Gewicht g	Bestell- nummer
Zoll	Zoll				
1/4	1/4	11,1	42	13	4027 1017 20
1/4	1/4	11,1	60	26	4027 1017 21

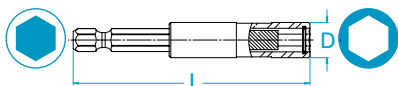

Bithalter, Sechskantantrieb Form E, für Bits mit Sechskant Form C mit Magnet



		Ø Abtrieb D mm	Länge L mm	Gewicht g	Bestell- nummer
Zoll	Zoll				
1/4	1/4	11,1	60	30	4027 1017 29
1/4	1/4	11,1	75	36	4023 1208 01
1/4	1/4	11,1	102	45	4023 1208 02
1/4	1/4	11,1	150	48	4023 1209 00

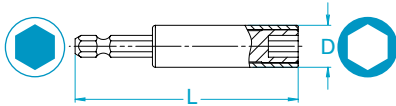

Bithalter, Sechskantantrieb Form E, für Bits mit Sechskant Form C mit Magnet, ROTACTION



		Ø Abtrieb D mm	Länge L mm	Gewicht g	Bestell- nummer	Schutzring Ref.	Ersatzhülsen Bestellnummer*
Zoll	Zoll						
1/4	1/4	14	60	35	4027 1017 49	TC16	4027 2984 98
1/4	1/4	14	75	40	4027 1017 40	TC16	4027 2984 89
1/4	1/4	14	102	50	4027 1017 41	TC12	4027 2984 91
1/4	1/4	14	150	70	4027 1017 42	TC12	4027 2984 90

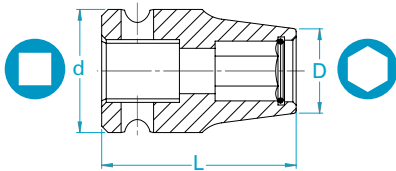

Bithalter, Vierkantantrieb, für Bits mit Sechskant Form C

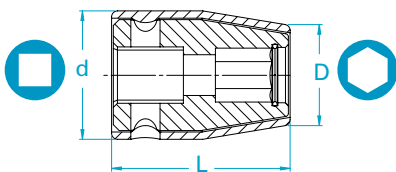

		Ø Antrieb d mm	Ø Abtrieb D mm	Länge L mm	Gewicht g	Bestell- nummer	Stift und O-Ring Ref.
Zoll	Zoll						
1/4	1/4	13	11	25	16	4027 1135 00	Z
3/8	1/4	19	11	30	37	4027 1235 00	Y
1/2	1/4	25	11	35	60	4027 1335 00	W

Bithalter, Vierkantantrieb, für Bits mit Sechskant Form C, ROTACTION





		Ø Antrieb d mm	Ø Abtrieb D mm	Länge L mm	Gewicht g	Bestell- nummer	Steckschlüssel Abdeckung Ref.	Ersatzhülsen Bestellnummer*
Zoll	Zoll							
1/4	1/4	16	14	25	20	4027 1135 70	C16	4027 2984 80
3/8	1/4	22	14	30	35	4027 1235 70	C22	4027 2980 84
1/2	1/4	28	14	35	80	4027 1335 70	C28	4027 2984 86

*Ersatzhülsen werden als 2er Satz mit Montageanleitung geliefert.

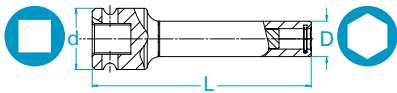

Bithalter, Vierkantantrieb, für Bits mit Sechskant Form C mit Magnet



		Ø Antrieb d mm	Ø Abtrieb D mm	Länge L mm	Gewicht g	Bestell- nummer	Stift und O-Ring Ref.
Zoll	Zoll						
1/4	1/4	13	11	44	30	4027 2000 80	Z
3/8	1/4	19	11	68	60	4027 1235 90	Y
1/2	1/4	25	11	70	80	4027 1335 90	W

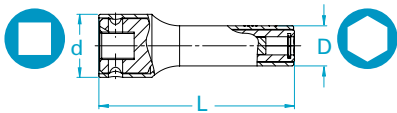

Bithalter, Vierkantantrieb, für Bits mit Sechskant Form C mit Magnet, ROTACTION

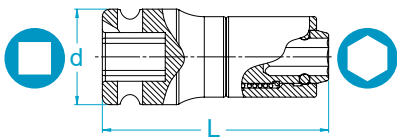

		Ø Antrieb d mm	Ø Abtrieb D mm	Länge L mm	Gewicht g	Bestell- nummer	Steckschlüssel Abdeckung Ref.	Ersatzhülsen Bestellnummer*
Zoll	Zoll							
1/4	1/4	16	14	44	35	4027 1135 80	C16	4027 2984 88
3/8	1/4	22	14	68	70	4027 1235 80	C22	4027 2984 94
1/2	1/4	28	14	70	95	4027 1335 80	C28	4027 2984 96

Schnellwechselfutter, Vierkantantrieb, für Bits mit Sechskant Form C



		Ø Antrieb d mm	Länge L mm	Gewicht g	Bestell- nummer	Stift und O-Ring Ref.
Zoll	Zoll					
3/8	1/4	19	45	56	4027 1236 00	Y
1/2	1/4	25	55	94	4027 1336 00	W

*Ersatzhülsen werden als 2er Satz mit Montageanleitung geliefert.



Antrieb 1/4", Sechskant, Form E

Antrieb 1/4", Sechskant, Form E..... 22

Bits, für Innensechskant-Schrauben.....	23
Bits, für Torx®-Schrauben	23
Bits, für Torx®-Schrauben mit Ringmagnet, ROTACTION.....	24
Bits, für TorxPlus®-Schrauben.....	24
Bits, für Phillips-Schrauben	25
Bits, für Pozidriv-Schrauben.....	25
Bits, für Schlitz-Schrauben	26
Bits, für Schlitz-Schrauben mit Findehülse	26
Steckschlüssel, Sechskant.....	27
Steckschlüssel, Sechskant, ROTACTION	27
Steckschlüssel, Sechskant mit Magnet	28
Steckschlüssel, Sechskant mit Magnet, ROTACTION.....	28
Steckschlüssel, Sechskant mit federndem Magnet.....	29
Steckschlüssel, Sechskant mit federndem Magnet, ROTACTION	29
Steckschlüssel, für Torx®-Schrauben.....	30
Steckschlüssel, für Torx®-Schrauben, ROTACTION.....	30
Steckschlüssel, für Torx®-Schrauben mit Magnet.....	31
Steckschlüssel, für Torx®-Schrauben mit Magnet, ROTACTION.....	31
Adapter, Außenvierkant mit Stiftarretierung	32
Adapter, Außenvierkant mit Stiftarretierung, ROTACTION	32
Bithalter, Sechskantantrieb Form E, für Bits mit Wing-shank 4mm.....	32
Bithalter, Sechskantantrieb Form E, für Bits mit Sechskant Form C.....	33
Bithalter, Sechskantantrieb Form E, für Bits mit Sechskant Form C mit Magnet. 33	
Bithalter, Sechskantantrieb Form E, für Bits mit Sechskant Form C mit Magnet, ROTACTION.....	33
Schnellwechselfutter, Vierkantantrieb, für Bits mit Sechskant Form E	34
Schnellwechselfutter, Vierkantantrieb, für Bits mit Sechskant Form E, ROTACTION.....	34
Schnellwechselfutter, Vierkantantrieb, für Bits mit Sechskant Form E, geführt.. 34	

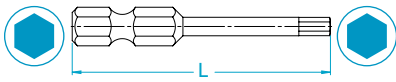

Bits, für Innensechskant-Schrauben

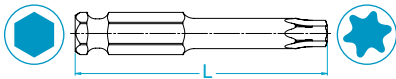

		Länge L mm	Gewicht g	max. Drehmoment Nm	Bestell- nummer
Zoll	mm				
1/4	2	49	5	1,6	4023 1311 00
1/4	2,5	49	6	3,1	4023 1312 00
1/4	3	49	7	5,3	4023 0710 00
1/4	4	49	8	13	4023 0711 00
1/4	5	49	9	25	4023 0712 00
1/4	6	49	10	43	4027 1038 06
1/4	8	49	16	49	4023 1369 00
1/4	10	49	19	49	4023 1370 00
Zoll	Zoll				
1/4	1/4	49	11	49	4023 0906 00

Bits, für Torx®-Schrauben





		Länge L mm	Gewicht g	max. Drehmoment Nm	Bestell- nummer
Zoll					
1/4	T5	49	6	0,36	4023 0002 16
1/4	T5	70	8	0,36	4023 0002 17
1/4	T6	49	8	0,64	4023 0001 61
1/4	T6	70	10	0,64	4023 0001 62
1/4	T6	89	12	0,64	4023 0001 63
1/4	T7	49	8	1,2	4023 0002 18
1/4	T7	70	10	1,2	4023 0002 19
1/4	T8	49	8	1,8	4023 2220 21
1/4	T8	89	12	1,8	4023 2235 21
1/4	T9	49	8	2,4	4023 2220 22
1/4	T9	89	12	2,4	4023 2235 22
1/4	T10	49	8	3,2	4023 2220 23
1/4	T10	89	12	3,2	4023 2235 23
1/4	T15	49	9	5,4	4023 2220 24
1/4	T15	89	13	5,4	4023 2235 24
1/4	T20	49	9	8,9	4023 2220 25
1/4	T20	89	13	8,9	4023 2235 25
1/4	T25	49	11	13	4023 2220 26
1/4	T25	70	14	13	4027 1090 25
1/4	T25	89	17	13	4023 2235 26
1/4	T27	49	11	19	4023 2220 27
1/4	T27	89	17	19	4023 2235 27
1/4	T30	49	13	26	4023 2220 28
1/4	T30	70	17	26	4027 1090 30
1/4	T30	89	21	26	4023 2235 28
1/4	T40	89	23	46	4023 2235 29

Torx®, Torx Plus® sind eingetragene Warenzeichen von Acument Intellectual Properties, LLC.



Bits, für Torx®-Schrauben mit Ringmagnet, ROTACTION



		Ø Abtrieb D mm	Länge L mm	Tiefe T mm	Gewicht g	max. Drehmoment Nm	Bestell- nummer	Schutzring Ref.
Zoll								
1/4	T10	9,7	150	2,1	38	3,2	4027 1043 11	TC10
1/4	T20	11,2	50	2,3	15	8,9	4027 1040 21	TC10
1/4	T20	11,2	75	2,3	20	8,9	4027 1041 21	TC10
1/4	T20	11,7	100	2,3	28	8,9	4027 1042 21	TC10
1/4	T20	11,8	150	2,3	40	8,9	4027 1043 21	TC10
1/4	T25	11,2	50	3	15	13	4027 1040 26	TC10
1/4	T25	11,2	75	3	20	13	4027 1041 26	TC10
1/4	T25	11,7	100	3	28	13	4027 1042 26	TC10
1/4	T25	11,8	150	3	40	13	4027 1043 26	TC10
1/4	T30	13,2	50	3,2	19	26	4027 1040 31	TC10
1/4	T30	13,2	75	3,2	25	26	4027 1041 31	TC10
1/4	T30	13,7	100	3,2	32	26	4027 1042 31	TC10
1/4	T30	13,8	150	3,2	48	26	4027 1043 31	TC10

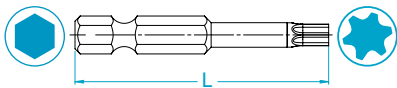

Bits, für TorxPlus®-Schrauben



		Länge L mm	max. Drehmoment Nm	Bestell- nummer
Zoll				
1/4	5IP	49	0,43	4023 0002 20
1/4	5IP	70	0,43	4023 0002 21
1/4	6IP	49	0,78	4023 0001 71
1/4	6IP	70	0,78	4023 0001 72
1/4	6IP	89	0,78	4023 0001 73
1/4	7IP	49	1,5	4023 0002 23
1/4	7IP	70	1,5	4023 0002 24
1/4	7IP	89	1,5	4023 0002 25
1/4	8IP	49	2,2	4023 0001 75
1/4	8IP	70	2,2	4023 0001 76
1/4	8IP	89	2,2	4023 0001 77
1/4	10IP	49	3,8	4023 0001 79
1/4	10IP	70	3,8	4023 0001 80
1/4	10IP	89	3,8	4023 0001 81



Bits, für Phillips-Schrauben



		Länge L mm	Gewicht g	max. Drehmoment Nm	Bestell- nummer
Zoll					
1/4	PH00	49	7	0,4	4023 0001 51
1/4	PH00	70	8	0,4	4023 0001 52
1/4	PH00	89	9	0,4	4023 0001 53
1/4	PH0	49	7	0,7	4023 1325 00
1/4	PH1	49	8	2,7	4023 2320 21
1/4	PH1	70	10	2,7	4023 2327 21
1/4	PH1	89	12	2,7	4023 2335 21
1/4	PH1	152	21	2,7	4023 2360 21
1/4	PH2	49	12	7,2	4023 2320 22
1/4	PH2	70	16	7,2	4023 2327 22
1/4	PH2	89	18	7,2	4023 2335 22
1/4	PH2	152	36	7,2	4023 2360 22
1/4	PH3	49	13	22	4023 2320 23
1/4	PH3	70	17	22	4023 2327 23
1/4	PH3	89	27	22	4023 2335 23
1/4	PH3	150	42	22	4023 2360 23



Bits, für Pozidriv-Schrauben



		Länge L mm	Gewicht g	max. Drehmoment Nm	Bestell- nummer
Zoll					
1/4	PZ0	49	7	0,7	4023 0001 41
1/4	PZ0	70	9	0,7	4023 0001 42
1/4	PZ1	49	8	2,7	4023 2420 21
1/4	PZ1	70	10	2,7	4023 2427 21
1/4	PZ1	89	12	2,7	4023 2435 21
1/4	PZ2	49	12	7,2	4023 2420 22
1/4	PZ2	70	16	7,2	4023 2427 22
1/4	PZ2	89	18	7,2	4023 2435 22
1/4	PZ3	49	13	22	4023 2420 23
1/4	PZ3	89	27	22	4023 2435 23

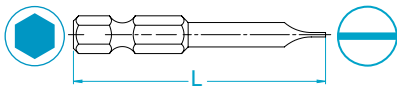

Bits, für Schlitz-Schrauben



		Länge L mm	Gewicht g	max. Drehmoment Nm	Bestell- nummer
Zoll	mm				
1/4	0,66x3,4	49	6	0,98	4023 2020 21
1/4	0,66x3,4	70	9	0,98	4023 2030 21
1/4	0,76x3,8	49	7	2	4023 2020 23
1/4	0,76x3,8	76	11	2	4023 2030 23
1/4	0,86x4,75	49	10	2,7	4023 2020 24
1/4	0,86x4,75	76	12	2,7	4023 2030 24
1/4	0,91x6,35	49	11	4,3	4023 2020 26
1/4	1,07x6,99	49	12	7,4	4023 2020 27
1/4	1,17x7,9	49	13	9	4023 2020 28
1/4	1,27x9,1	49	13	16	4023 2020 29

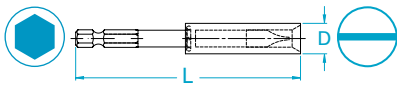

Bits, für Schlitz-Schrauben mit Findehülse



		Ø Abtrieb D mm	Länge L mm	Gewicht g	max. Drehmoment Nm	Bestell- nummer
Zoll	mm					
1/4	0,91x5	9,5	95	29	3,5	4023 0683 00
1/4	0,97x6,12	11,1	95	39	4,7	4023 1313 00
1/4	1,07x7	12,7	95	49	7,4	4023 0684 00
1/4	1,17x9	14,2	95	66	9	4023 0949 00
1/4	1,27x10	15,8	98	78	16	4023 0685 00

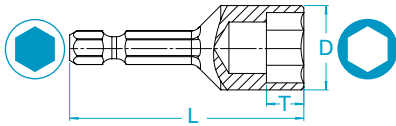

Steckschlüssel, Sechskant

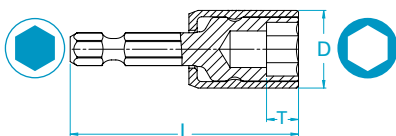

		Ø Abtrieb D mm	Länge L mm	Tiefe T mm	Gewicht g	max. Drehmoment Nm	Bestell- nummer
Zoll	mm						
1/4	5,5	9	50	4	15	12	4027 1000 55
1/4	7	11	50	5	19	19	4027 1000 07
1/4	7	11,5	100	5	40	19	4027 1002 07
1/4	7	11,5	150	5	62	19	4027 1003 07
1/4	7	11,5	200	5	78	19	4027 1004 07
1/4	8	12	50	6	20	24	4027 1000 08
1/4	8	12,7	75	6	32	24	4027 1001 08
1/4	8	12,7	100	6	41	24	4027 1002 08
1/4	8	12,7	150	6	60	24	4027 1003 08
1/4	8	12,7	200	6	82	24	4027 1004 08
1/4	10	14,2	50	7	31	34	4027 1000 10
1/4	10	14,5	75	7	37	34	4027 1001 10
1/4	10	14,5	100	7	45	34	4027 1002 10
1/4	10	14,5	150	7	68	34	4027 1003 10
1/4	10	14,5	200	7	83	34	4027 1004 10
1/4	11	16	50	8	36	40	4027 1000 11
1/4	13	18	50	8	42	49	4027 1000 13
1/4	13	18	100	8	47	49	4027 1002 13
1/4	13	18	150	8	75	49	4027 1003 13
1/4	13	18	200	8	92	49	4027 1004 13
1/4	15	20,6	100	10	68	49	4027 1002 15
1/4	17	23,1	100	11	90	49	4027 1002 17

Steckschlüssel, Sechskant, ROTACTION



		Ø Abtrieb D mm	Länge L mm	Tiefe T mm	Gewicht g	max. Drehmoment Nm	Bestell- nummer	Schutzring Ref.	Ersatzhülsen Bestellnummer*
Zoll	mm								
1/4	7	13,5	50	5	20	19	4027 1087 07	TC16	4027 2984 35
1/4	8	14,8	50	6	22	24	4027 1087 08	TC16	4027 2980 15
1/4	10	17	50	7	25	34	4027 1087 10	TC16	4027 2980 16
1/4	10	17,3	100	7	50	34	4027 1074 10	TC12	4027 2981 72
1/4	13	20,8	50	8	30	49	4027 1087 13	TC16	4027 2980 17
1/4	13	20,8	100	8	70	49	4027 1074 13	TC12	4027 2984 77
1/4	15	23,3	100	10	70	49	4027 1074 15	TC12	4027 2984 78
1/4	17	25,8	100	11	100	49	4027 1074 17	TC12	4027 2984 79

*Ersatzhülsen werden als 2er Satz mit Montageanleitung geliefert.

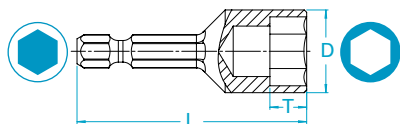

Steckschlüssel, Sechskant mit Magnet

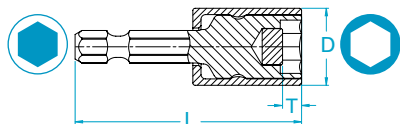

		Ø Abtrieb D mm	Länge L mm	Tiefe T mm	Gewicht g	max. Drehmoment Nm	Bestell- nummer
Zoll	mm						
1/4	5,5	9	50	2,1	16	12	4027 1005 55
1/4	7	11	50	2,8	23	19	4027 1005 07
1/4	7	11,5	75	2,8	32	19	4027 1006 07
1/4	7	11,5	100	2,8	50	19	4027 1007 07
1/4	7	11,5	150	2,8	62	19	4027 1008 07
1/4	8	12	50	3,5	27	24	4027 1005 08
1/4	8	12,7	75	3,5	35	24	4027 1006 08
1/4	8	12,7	100	3,5	45	24	4027 1007 08
1/4	8	12,7	150	3,5	62	24	4027 1008 08
1/4	10	14,2	50	4,2	29	34	4027 1005 10
1/4	10	14,5	75	4,2	39	34	4027 1006 10
1/4	10	14,5	100	4,2	50	34	4027 1007 10
1/4	10	14,5	150	4,2	77	34	4027 1008 10
1/4	11	16	50	4,9	39	40	4027 1005 11
1/4	12	17	50	5,6	40	46	4027 1005 12
1/4	13	18	50	6	50	49	4027 1005 13
1/4	13	18	75	6	49	49	4027 1006 13
1/4	13	18	100	6	62	49	4027 1007 13
1/4	13	18	150	6	80	49	4027 1008 13

Steckschlüssel, Sechskant mit Magnet, ROTACTION



		Ø Abtrieb D mm	Länge L mm	Tiefe T mm	Gewicht g	max. Drehmoment Nm	Bestell- nummer	Schutzring Ref.	Ersatzhülsen Bestellnummer*
Zoll	mm								
1/4	7	14,3	100	2,8	40	19	4027 1067 07	TC12	4027 2984 44
1/4	8	14,8	50	3,5	20	24	4027 1077 08	TC16	4027 2986 00
1/4	8	15,5	75	3,5	37	24	4027 1066 08	TC12	4027 2980 21
1/4	8	15,5	100	3,5	50	24	4027 1067 08	TC12	4027 2984 41
1/4	8	15,5	150	3,5	70	24	4027 1068 08	TC12	4027 2984 42
1/4	10	17	50	4,2	29	34	4027 1077 10	TC16	4027 2985 99
1/4	10	17,3	75	4,2	43	34	4027 1066 10	TC12	4027 2980 22
1/4	10	17,3	100	4,2	60	34	4027 1067 10	TC12	4027 2984 40
1/4	10	17,3	150	4,2	80	34	4027 1068 10	TC12	4027 2984 43
1/4	13	20,8	50	6	40	49	4027 1077 13	TC16	4027 2985 02
1/4	13	20,8	75	6	56	49	4027 1066 13	TC12	4027 2980 23
1/4	13	20,8	100	6	70	49	4027 1067 13	TC12	4027 2984 39

*Ersatzhülsen werden als 2er Satz mit Montageanleitung geliefert.

Steckschlüssel, Sechskant mit federndem Magnet*

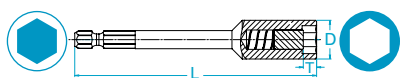



		Ø Abtrieb D mm	Länge L mm	Tiefe T mm	Gewicht g	max. Drehmoment Nm	Bestell- nummer
Zoll	mm						
1/4	7	11,5	75	3,5	36	19	4027 1063 07
1/4	7	11,5	100	3,5	48	19	4027 1009 07
1/4	8	12,7	75	4	41	24	4027 1063 08
1/4	8	12,7	100	4	51	24	4027 1009 08
1/4	8	12,7	150	4	68	24	4027 1010 08
1/4	8	12,7	200	4	95	24	4027 1064 08
1/4	8	12,7	250	4	112	24	4027 1065 08
1/4	10	14,5	75	4,5	43	34	4027 1063 10
1/4	10	14,5	100	4,5	57	34	4027 1009 10
1/4	10	14,5	150	4,5	77	34	4027 1010 10
1/4	10	14,5	200	4,5	96	34	4027 1064 10
1/4	10	14,5	250	4,5	116	34	4027 1065 10
1/4	12	17	75	6	65	46	4027 1063 12
1/4	12	17	100	6	77	46	4027 1009 12
1/4	12	17	150	6	101	46	4027 1010 12
1/4	12	17	200	6	125	46	4027 1064 12
1/4	12	17	250	6	149	46	4027 1065 12
1/4	13	18	75	6,5	72	49	4027 1063 13
1/4	13	18	100	6,5	82	49	4027 1009 13
1/4	13	18	150	6,5	106	49	4027 1010 13
1/4	13	18	200	6,5	130	49	4027 1064 13
1/4	13	18	250	6,5	154	49	4027 1065 13
1/4	14	19	75	7	74	49	4027 1063 14
1/4	14	19	100	7	83	49	4027 1009 14
1/4	14	19	150	7	110	49	4027 1010 14
1/4	14	19	200	7	135	49	4027 1064 14
1/4	14	19	250	7	160	49	4027 1065 14

* Federweg ca. 20 mm

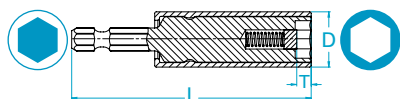
Steckschlüssel, Sechskant mit federndem Magnet*, ROTACTION



		Ø Abtrieb D mm	Länge L mm	Tiefe T mm	Gewicht g	max. Drehmoment Nm	Bestell- nummer	Schutzring Ref.	Ersatzhülsen Bestellnummer***
Zoll	mm								
1/4	7	14,5	75	3,5	40	19	4027 1085 07	TC16	4027 2981 58
1/4	7	14,5	100	3,5	58	19	4027 1084 07	TC12	4027 2981 55
1/4	8	15,5	75	4	41	24	4027 1085 08	TC16	4027 2980 24
1/4	8	15,5	100	4	60	24	4027 1084 08	TC12	4027 2981 54
1/4	10	17,3	75	4,5	48	34	4027 1085 10	TC16	4027 2980 25
1/4	10	17,3	100	4,5	66	34	4027 1084 10	TC12	4027 2981 56
1/4	13	20,8	75	6,5	72	49	4027 1085 13	TC16	4027 2980 26
1/4	13	20,8	100	6,5	100	49	4027 1084 13	TC12	4027 2984 36

* Federweg ca. 20 mm

**Ersatzhülsen werden als 2er Satz mit Montageanleitung geliefert.

Steckschlüssel, für Torx®-Schrauben

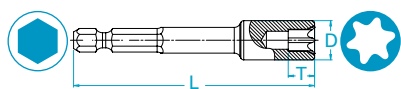

		Ø Abtrieb D mm	Länge L mm	Tiefe T mm	Gewicht g	max. Drehmoment Nm	Bestell- nummer
Zoll							
1/4	E6	8,7	50	4,4	17	10	4027 1070 06
1/4	E6	8,7	75	4,4	24	10	4027 1071 06
1/4	E6	8,7	100	4,4	30	10	4027 1086 06
1/4	E7	9,2	50	5,6	18	15	4027 1070 07
1/4	E7	9,2	75	5,6	26	15	4027 1071 07
1/4	E7	9,2	100	5,6	43	15	4027 1086 07
1/4	E8	9,7	50	6	19	28	4027 1070 08
1/4	E8	9,7	75	6	27	28	4027 1071 08
1/4	E8	9,7	100	6	40	28	4027 1086 08
1/4	E10	12,2	50	7	20	49	4027 1070 10
1/4	E10	12,2	75	7,2	28	49	4027 1071 10
1/4	E10	12,2	100	7,2	35	49	4027 1086 10
1/4	E12	14,2	50	8,3	31	49	4027 1070 12
1/4	E12	14,2	75	8,3	45	49	4027 1071 12
1/4	E12	14,2	100	8,3	58	49	4027 1086 12

Steckschlüssel, für Torx®-Schrauben, ROTACTION

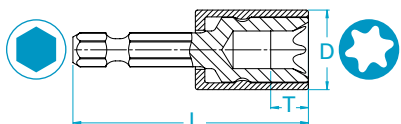

		Ø Abtrieb D mm	Länge L mm	Tiefe T mm	Gewicht g	max. Drehmoment Nm	Bestell- nummer	Schutzring Ref.	Ersatzhülsen Bestellnummer**
Zoll									
1/4	E6	11,5	50	5,4	18	10	4027 1073 06	TC12	4027 2984 38
1/4	E6	11,5	75	5,4	25	10	4027 1080 06	TC12	4027 2984 50
1/4	E6	11,5	100	5,4	31	10	4027 1083 06	TC12	4027 2984 60
1/4	E7	12	50	5,6	19	15	4027 1073 07	TC12	4027 2984 37
1/4	E7	12	75	6,6	27	15	4027 1080 07	TC12	4027 2984 51
1/4	E7	12	100	6,6	44	15	4027 1083 07	TC12	4027 2984 61
1/4	E8	12,9	50	6	20	28	4027 1073 08	TC16	4027 2980 27
1/4	E8	12,9	75	6,6	28	28	4027 1080 08	TC12	4027 2984 52
1/4	E8	12,9	100	7	41	28	4027 1083 08	TC12	4027 2984 62
1/4	E10	15	50	7,4	21	49	4027 1073 10	TC16	4027 2980 28
1/4	E10	15	75	8,2	29	49	4027 1080 10	TC12	4027 2984 53
1/4	E10	15	100	8,2	36	49	4027 1083 10	TC12	4027 2984 63
1/4	E12	17	50	8,3	32	49	4027 1073 12	TC16	4027 2980 29
1/4	E12	17	75	9,3	46	49	4027 1080 12	TC12	4027 2984 54
1/4	E12	17	100	9,3	59	49	4027 1083 12	TC12	4027 2984 64

*Ersatzhülsen werden als 2er Satz mit Montageanleitung geliefert.

Torx®, Torx Plus® sind eingetragene Warenzeichen von Acument Intellectual Properties, LLC.

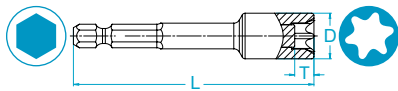

Steckschlüssel, für Torx®-Schrauben mit Magnet

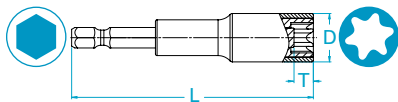

		Ø Abtrieb D mm	Länge L mm	Tiefe T mm	Gewicht g	max. Drehmoment Nm	Bestell- nummer
Zoll							
1/4	E6	8,7	50	4	23	10	4027 1070 56
1/4	E6	8,7	75	4	30	10	4027 1071 56
1/4	E6	8,7	100	4	36	10	4027 1086 56
1/4	E7	9,2	50	4,5	25	15	4027 1070 57
1/4	E7	9,2	75	4,5	33	15	4027 1071 57
1/4	E7	9,2	100	4,5	50	15	4027 1086 57
1/4	E8	9,7	50	5,5	27	28	4027 1070 58
1/4	E8	9,7	75	5,5	35	28	4027 1071 58
1/4	E8	9,7	100	5,5	48	28	4027 1086 58
1/4	E10	12,2	50	6	29	49	4027 1070 60
1/4	E10	12,2	75	6	38	49	4027 1071 60
1/4	E10	12,2	100	6	44	49	4027 1086 60
1/4	E12	14,2	50	6	41	49	4027 1070 62
1/4	E12	14,2	75	6	55	49	4027 1071 62
1/4	E12	14,2	100	6	68	49	4027 1086 62

Steckschlüssel, für Torx®-Schrauben mit Magnet, ROTACTION





		Ø Abtrieb D mm	Länge L mm	Tiefe T mm	Gewicht g	max. Drehmoment Nm	Bestell- nummer	Schutzring Ref.	Ersatzhülsen Bestellnummer**
Zoll									
1/4	E6	11,5	50	4	24	10	4027 1073 56	TC16	4027 2984 45
1/4	E6	11,5	75	4	31	10	4027 1080 56	TC12	4027 2984 55
1/4	E6	11,5	100	4	37	10	4027 1083 56	TC12	4027 2984 65
1/4	E7	12	50	4,5	26	15	4027 1073 57	TC16	4027 2984 46
1/4	E7	12	75	4,5	34	15	4027 1080 57	TC12	4027 2984 56
1/4	E7	12	100	4,5	51	15	4027 1083 57	TC12	4027 2984 66
1/4	E8	12,9	50	5,5	28	28	4027 1073 58	TC12	4027 2984 47
1/4	E8	12,9	75	5,5	36	28	4027 1080 58	TC12	4027 2984 57
1/4	E8	12,9	100	5,5	49	28	4027 1083 58	TC12	4027 2984 67
1/4	E10	15	50	6	30	49	4027 1073 60	TC16	4027 2984 48
1/4	E10	15	75	6	38	49	4027 1080 60	TC12	4027 2984 58
1/4	E10	15	100	6	45	49	4027 1083 60	TC12	4027 2984 68
1/4	E12	17	50	6	42	49	4027 1073 62	TC16	4027 2984 49
1/4	E12	17	75	6	56	49	4027 1080 62	TC12	4027 2984 59
1/4	E12	17	100	6	69	49	4027 1083 62	TC12	4027 2984 69

*Ersatzhülsen werden als 2er Satz mit Montageanleitung geliefert.

Torx®, Torx Plus® sind eingetragene Warenzeichen von Acument Intellectual Properties, LLC.

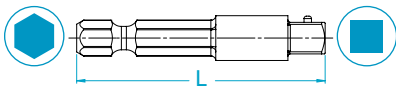

Adapter, Außenvierkant mit Stiftarretierung



		Länge L mm	Gewicht g	Bestell- nummer
Zoll	Zoll			
1/4	1/4	50	15	4027 1017 00
1/4	1/4	75	24	4027 1017 01
1/4	1/4	100	34	4027 1017 02
1/4	1/4	125	44	4027 1017 03
1/4	1/4	150	54	4027 1017 04
1/4	3/8	50	22	4027 1017 10
1/4	3/8	75	46	4027 1017 11
1/4	3/8	100	71	4027 1017 12
1/4	3/8	125	96	4027 1017 13
1/4	3/8	150	121	4027 1017 14

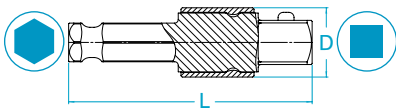

Adapter, Außenvierkant mit Stiftarretierung, ROTACTION

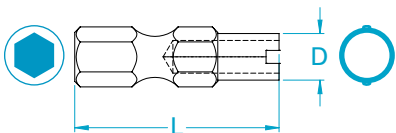

		Länge L mm	Gewicht g	Bestell- nummer	Schutzring Ref.	Ersatzhülsen Bestellnummer*
Zoll	Zoll					
1/4	1/4	50	20	4027 1017 05	TC12	4027 2984 82
1/4	1/4	75	30	4027 1017 06	TC12	4027 2984 83
1/4	1/4	100	41	4027 1017 07	TC12	4027 2981 74
1/4	1/4	125	52	4027 1017 08	TC12	4027 2984 81
1/4	1/4	150	63	4027 1017 09	TC12	4027 2981 81
1/4	3/8	50	28	4027 1017 15	TC16	4027 2984 84
1/4	3/8	75	53	4027 1017 16	TC16	4027 2981 52
1/4	3/8	100	79	4027 1017 17	TC12	4027 2981 53
1/4	3/8	125	105	4027 1017 18	TC12	4027 2984 85
1/4	3/8	150	131	4027 1017 19	TC12	4027 2981 78

Bithalter, Sechskantantrieb Form E, für Bits mit Wing-shank 4mm





		Ø Abtrieb D mm	Länge L mm	Gewicht g	Bestell- nummer
Zoll	mm				
1/4	Wing-shank Ø 4	5,7	25	4	4220 0105 00

*Ersatzhülsen werden als 2er Satz mit Montageanleitung geliefert.

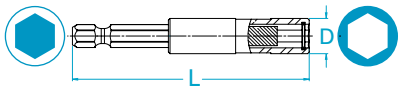

Bithalter, Sechskantantrieb Form E, für Bits mit Sechskant Form C



		Ø Abtrieb D mm	Länge L mm	Gewicht g	Bestell- nummer
Zoll	Zoll				
1/4	1/4	11,1	42	13	4027 1017 20
1/4	1/4	11,1	60	26	4027 1017 21

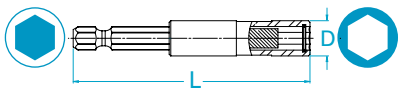

Bithalter, Sechskantantrieb Form E, für Bits mit Sechskant Form C mit Magnet

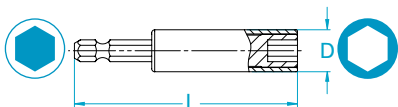

		Ø Abtrieb D mm	Länge L mm	Gewicht g	Bestell- nummer
Zoll	Zoll				
1/4	1/4	11,1	60	30	4027 1017 29
1/4	1/4	11,1	75	36	4023 1208 01
1/4	1/4	11,1	102	45	4023 1208 02
1/4	1/4	11,1	150	48	4023 1209 00

Bithalter, Sechskantantrieb Form E, für Bits mit Sechskant Form C mit Magnet, ROTACTION





		Ø Abtrieb D mm	Länge L mm	Gewicht g	Bestell- nummer	Schutzring Ref.	Ersatzhülsen Bestellnummer*
Zoll	Zoll						
1/4	1/4	14	60	35	4027 1017 49	TC16	4027 2984 98
1/4	1/4	14	75	40	4027 1017 40	TC16	4027 2984 89
1/4	1/4	14	102	50	4027 1017 41	TC12	4027 2984 91
1/4	1/4	14	150	70	4027 1017 42	TC12	4027 2984 90

*Ersatzhülsen werden als 2er Satz mit Montageanleitung geliefert.

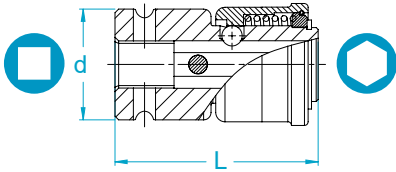

Schnellwechselfutter, Vierkantantrieb, für Bits mit Sechskant Form E



		Ø Antrieb d mm	Länge L mm	Gewicht g	Stift und O-Ring Ref.	Bestell- nummer
Zoll	Zoll					
3/8	1/4	22	46	53	X	4027 1236 01

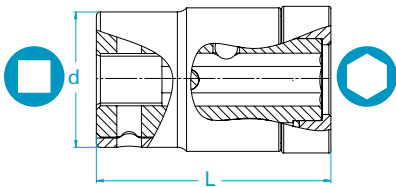

Schnellwechselfutter, Vierkantantrieb, für Bits mit Sechskant Form E, ROTACTION

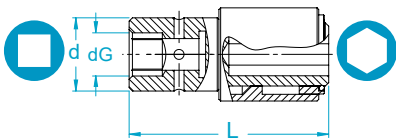

		Ø Antrieb d mm	Länge L mm	Gewicht g	Steckschlüssel Abdeckung Ref.	Bestell- nummer
Zoll	Zoll					
3/8	1/4	22	46	75	C22	4027 1236 21

Schnellwechselfutter, Vierkantantrieb, für Bits mit Sechskant Form E, geführt



		Ø Antrieb d mm	Ø Führung d _G mm	Länge L mm	Gewicht g	Stift und O-Ring Ref.	Bestell- nummer
Zoll	Zoll						
3/8	1/4	20	13	52	77	X	4026 4501 00

Antrieb 5/16", Sechskant, Form C





Antrieb 5/16", Sechskant, Form C 35

Bits, für Innensechskant-Schrauben.....	36
Bits, für Torx®-Schrauben	36
Bithalter, Vierkantantrieb, für Bits mit Sechskant Form C	36
Bithalter, Vierkantantrieb, für Bits mit Sechskant Form C, ROTACTION.....	37
Bithalter, Vierkantantrieb, für Bits mit Sechskant Form C mit Magnet.....	37
Bithalter, Vierkantantrieb, für Bits mit Sechskant Form C mit Magnet, ROTACTION.....	37
Schnellwechselfutter, Vierkantantrieb, für Bits mit Sechskant Form C.....	37

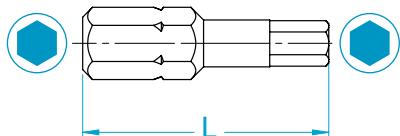

Bits, für Innensechskant-Schrauben



		Länge L mm	max. Drehmoment Nm	Bestell- nummer
Zoll	mm			
5/16	5	34	25	4023 1215 00
5/16	6	34	43	4023 1216 00
5/16	7	34	68	4023 1219 00
5/16	8	34	98	4023 1217 00
5/16	10	34	100	4023 1218 00

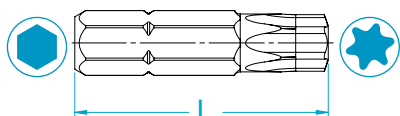

Bits, für Torx®-Schrauben

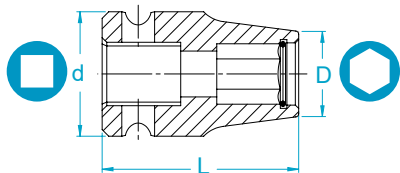

		Länge L mm	max. Drehmoment Nm	Bestell- nummer
Zoll				
5/16	T30	35	26	4027 1033 30
5/16	T40	35	46	4027 1033 40
5/16	T45	35	72	4027 1033 45
5/16	T50	35	100	4027 1033 50

Bithalter, Vierkantantrieb, für Bits mit Sechskant Form C



		Ø Antrieb d mm	Ø Abtrieb D mm	Länge L mm	Gewicht g	Stift und O-Ring Ref.	Bestell- nummer
Zoll	Zoll						
3/8	5/16	19	14	30	34	Y	4027 1235 01
1/2	5/16	25	14	35	62	W	4027 1335 01

Bithalter, Vierkantantrieb, für Bits mit Sechskant Form C, ROTACTION

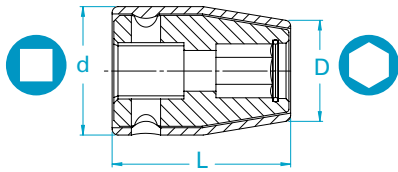

		Ø Antrieb d mm	Ø Abtrieb D mm	Länge L mm	Gewicht g	Steckschlüssel Abdeckung Ref.	Bestell- nummer	Ersatzhülsen Bestellnummer*
Zoll	Zoll							
3/8	5/16	22	17	30	38	C22	4027 1235 71	4027 2980 85
1/2	5/16	28	17	38	68	C28	4027 1335 71	4027 2980 86

Bithalter, Vierkantantrieb, für Bits mit Sechskant Form C mit Magnet

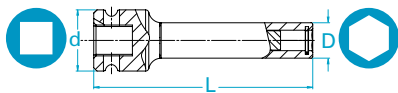

		Ø Antrieb d mm	Ø Abtrieb D mm	Länge L mm	Gewicht g	Stift und O-Ring Ref.	Bestell- nummer
Zoll	Zoll						
3/8	5/16	19	14	68	80	Y	4027 1235 92
1/2	5/16	25	14	70	100	W	4027 1335 92

Bithalter, Vierkantantrieb, für Bits mit Sechskant Form C mit Magnet, ROTACTION

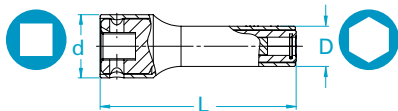

		Ø Antrieb d mm	Ø Abtrieb D mm	Länge L mm	Gewicht g	Bestell- nummer	Steckschlüssel Abdeckung Ref.	Ersatzhülsen Bestellnummer*
Zoll	Zoll							
3/8	5/16	22	17	68	90	4027 1235 82	C22	4027 2984 95
1/2	5/16	28	17	70	105	4027 1335 82	C28	4027 2984 97

Schnellwechselfutter, Vierkantantrieb, für Bits mit Sechskant Form C

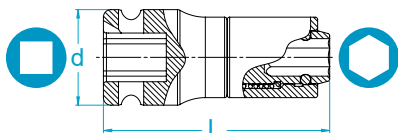

		Ø Antrieb d mm	Länge L mm	Gewicht g	Bestell- nummer	Stift und O-Ring Ref.	Ersatzhülsen Bestellnummer*
Zoll	Zoll						
3/8	5/16	22	39,5	98	4027 1236 02	X	4027 2994 95

*Ersatzhülsen werden als 2er Satz mit Montageanleitung geliefert.

Antrieb 7/16", Sechskant, Form E..... 38

Bits, für Innensechskant-Schrauben..... 39

Bits, für Torx®-Schrauben 39

Bits, für XZN-Schrauben..... 40

Steckschlüssel, Sechskant..... 40

Gelenkschlüssel, Sechskant 41

Adapter, Außenvierkant mit Stiftarretierung..... 42

Adapter, Außenvierkant mit Stiftarretierung, ROTACTION 42

Schnellwechselfutter, Vierkantantrieb, für Bits mit Sechskant Form E 42



Schnellwechselfutter, Vierkantantrieb, für Bits mit Sechskant Form E,
ROTACTION..... 43

Schnellwechselfutter, Vierkantantrieb, für Bits mit Sechskant Form E, geführt.. 43



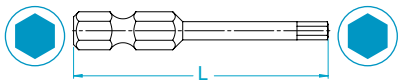

Bits, für Innensechskant-Schrauben



		Länge L mm	Gewicht g	max. Drehmoment Nm	Bestell- nummer
Zoll	mm				
7/16	5	70	44	25	4023 0800 00
7/16	5	100	39	25	4027 1052 05
7/16	6	70	48	43	4023 0801 00
7/16	6	100	44	43	4027 1052 06
7/16	8	70	53	98	4023 0802 00
7/16	8	100	64	98	4027 1052 08
7/16	10	70	54	179	4023 0760 00



Bits, für Torx®-Schrauben



		Länge L mm	Gewicht g	max. Drehmoment Nm	Bestell- nummer
Zoll					
7/16	T30	75	43	26	4027 1054 30
7/16	T30	150	80	26	4027 1055 30
7/16	T40	75	44	46	4027 1054 40
7/16	T40	150	82	46	4027 1055 40
7/16	T45	75	45	72	4027 1054 45
7/16	T45	150	82	72	4027 1055 45
7/16	T50	75	46	111	4027 1054 50
7/16	T50	150	83	111	4027 1055 50
7/16	T55	75	58	180	4027 1054 55
7/16	T55	150	121	180	4027 1055 55



Bits, für XZN-Schrauben



		Länge L mm	Gewicht g	max. Drehmoment Nm	Bestell- nummer
Zoll					
7/16	08	150	93	43	4027 1058 08
7/16	10	50	35	98	4027105610
7/16	10	150	97	98	4027 1058 10
7/16	12	150	143	154	4027 1058 12
7/16	14	150	162	259	4027 1058 14

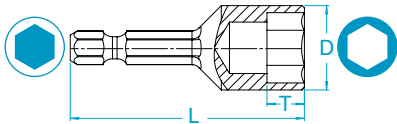

Steckschlüssel, Sechskant



		Ø Abtrieb D mm	Länge L mm	Tiefe T mm	Gewicht g	max. Drehmoment Nm	Bestell- nummer
Zoll	mm						
7/16	10	16	90	7	78	103	4027 1011 10
7/16	10	16	150	7	146	103	4027 1012 10
7/16	11	17,5	90	8	90	125	4027 1011 11
7/16	11	17,5	150	8	152	125	4027 1012 11
7/16	12	18,5	90	9	95	148	4027 1011 12
7/16	12	18,5	150	9	153	148	4027 1012 12
7/16	13	20	100	9,5	105	174	4027 1011 13
7/16	13	20	150	9,5	157	174	4027 1012 13
7/16	14	21,5	100	10	110	201	4027 1011 14
7/16	14	21,5	150	10	172	201	4027 1012 14
7/16	15	23	100	11	134	231	4027 1011 15
7/16	15	23	150	11	175	231	4027 1012 15
7/16	16	25,5	100	12	154	264	4027 1011 16
7/16	16	25,5	150	12	212	264	4027 1012 16
7/16	17	25,5	100	12	130	277	4027 1011 17
7/16	17	25,5	150	12	210	277	4027 1012 17
7/16	18	27,5	100	14	186	277	4027 1011 18
7/16	18	27,5	150	14	264	277	4027 1012 18
7/16	19	27,5	100	14	163	277	4027 1011 19
7/16	19	27,5	150	14	243	277	4027 1012 19
7/16	21	32,5	100	16	220	277	4027 1011 21
7/16	21	32,5	150	16	325	277	4027 1012 21
7/16	22	32,5	110	16	225	277	4027 1011 22
7/16	22	32,5	150	16	325	277	4027 1012 22

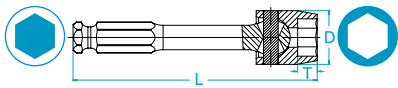

Gelenkschlüssel, Sechskant



		Ø Abtrieb D mm	Länge L mm	Tiefe T mm	Gewicht g	Bestell- nummer
Zoll	mm					
7/16	10	18	100	7	72	4027 1013 10
7/16	10	18	150	7	85	4027 1014 10
7/16	10	18	200	7	100	4027 1015 10
7/16	10	18	300	7	128	4027 1016 10
7/16	11	19	100	7	82	4027 1013 11
7/16	11	19	150	7	100	4027 1014 11
7/16	12	20	100	8	84	4027 1013 12
7/16	12	20	150	8	106	4027 1014 12
7/16	12	20	200	8	125	4027 1015 12
7/16	13	22	100	8	105	4027 1013 13
7/16	13	22	150	8	135	4027 1014 13
7/16	13	22	200	8	165	4027 1015 13
7/16	13	22	300	8	225	4027 1016 13
7/16	14	23	100	9	115	4027 1013 14
7/16	14	23	150	9	147	4027 1014 14
7/16	14	23	200	9	175	4027 1015 14
7/16	15	24	100	9	130	4027 1013 15
7/16	15	24	150	9	160	4027 1014 15
7/16	15	24	200	9	192	4027 1015 15
7/16	15	24	300	9	250	4027 1016 15
7/16	16	27	100	10	160	4027 1013 16
7/16	16	27	150	10	192	4027 1014 16
7/16	16	27	200	10	220	4027 1015 16
7/16	16	27	300	10	282	4027 1016 16
7/16	17	27	100	10	160	4027 1013 17
7/16	17	27	150	10	192	4027 1014 17
7/16	17	27	200	10	220	4027 1015 17
7/16	17	27	300	10	278	4027 1016 17
7/16	18	30	100	12	210	4027 1013 18
7/16	18	30	150	12	255	4027 1014 18
7/16	18	30	200	12	300	4027 1015 18
7/16	18	30	300	12	390	4027 1016 18
7/16	19	30	100	12	210	4027 1013 19
7/16	19	30	150	12	255	4027 1014 19
7/16	19	30	200	12	300	4027 1015 19
7/16	19	30	300	12	390	4027 1016 19
7/16	21	34	100	13	272	4027 1013 21
7/16	21	34	150	13	330	4027 1014 21
7/16	21	34	200	13	390	4027 1015 21
7/16	22	34	100	13	270	4027 1013 22
7/16	22	34	150	13	330	4027 1014 22
7/16	22	34	200	13	391	4027 1015 22

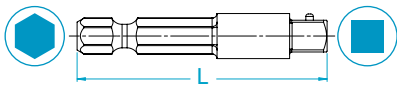

Adapter, Außenvierkant mit Stiftarretierung



		Länge L mm	Gewicht g	Bestell- nummer
Zoll	Zoll			
7/16	3/8	43	40	4027 1018 00
7/16	3/8	70	63	4027 1018 01
7/16	3/8	125	124	4027 1018 03
7/16	3/8	200	209	4027 1018 05
7/16	1/2	48	53	4027 1018 10
7/16	1/2	70	75	4027 1018 11
7/16	1/2	125	142	4027 1018 13
7/16	1/2	200	235	4027 1018 15

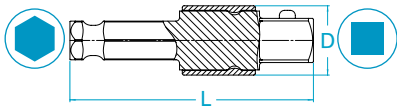

Adapter, Außenvierkant mit Stiftarretierung, ROTACTION

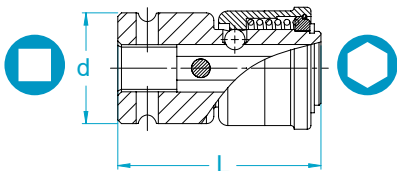

		Länge L mm	Gewicht g	Bestell- nummer	Ersatzhülsen Bestellnummer*
Zoll	Zoll				
7/16	3/8	70	62	4027 1018 06	4027 2980 78
7/16	3/8	125	122	4027 1018 07	4027 2980 79
7/16	3/8	200	205	4027 1018 09	4027 2980 80
7/16	1/2	70	85	4027 1018 16	4027 2980 81
7/16	1/2	125	145	4027 1018 17	4027 2980 82
7/16	1/2	200	240	4027 1018 19	4027 2980 83

Schnellwechselfutter, Vierkantantrieb, für Bits mit Sechskant Form E





		Ø Antrieb d mm	Länge L mm	Gewicht g	Stift und O-Ring Ref.	Bestell- nummer
Zoll	Zoll					
3/8	7/16	22	45	141	X	4027 1236 03
1/2	7/16	30	55	216	V	4027 1336 03
5/8	7/16	35	55	249	R	4027 1436 03

*Ersatzhülsen werden als 2er Satz mit Montageanleitung geliefert.

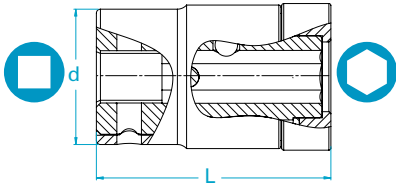

Schnellwechselfutter, Vierkantantrieb, für Bits mit Sechskant Form E, ROTACTION

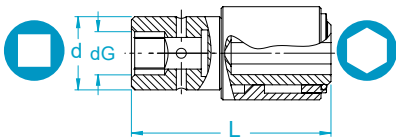

		Ø Antrieb d mm	Länge L mm	Gewicht g	Steckschlüssel Abdeckung Ref.	Bestell- nummer
Zoll	Zoll					
3/8	7/16	25	45	162	C25	4027 1236 23
1/2	7/16	33	55	200	C33	4027 1336 23

Schnellwechselfutter, Vierkantantrieb, für Bits mit Sechskant Form E, geführt



		Ø Antrieb d mm	Ø Führung d _G mm	Länge L mm	Gewicht g	Stift und O-Ring Ref.	Bestell- nummer
Zoll	Zoll						
3/8	7/16	22	13	60	156	X	4026 4502 00
1/2	7/16	28	18	68	216	V	4026 4503 00



Vierkantantrieb 1/4"

Vierkantantrieb 1/4"..... 44

Steckschlüssel, Sechskant.....	45
Steckschlüssel, Sechskant, ROTACTION.....	46
Steckschlüssel, Sechskant mit Magnet.....	46
Steckschlüssel, Sechskant mit Magnet, ROTACTION.....	47
Steckschlüssel, Sechskant mit Magnet, für selbstschneidende Schrauben.....	47
Steckschlüssel, Sechskant mit Einführschrägen.....	47
Steckschlüssel, Surface Drive.....	48
Steckschlüssel, Surface Drive, ROTACTION.....	48
Steckschlüssel, für Torx®-Schrauben.....	48
Steckschlüssel, für Torx®-Schrauben, ROTACTION.....	49
Steckschlüssel, für Torx®-Schrauben mit Magnet.....	49
Steckschlüssel, für Torx®-Schrauben mit Magnet, ROTACTION.....	49
Steckschlüssel, Sechskant mit federndem Magnet.....	50
Steckschlüssel, Sechskant mit federndem Magnet, ROTACTION.....	50
Bit Steckschlüssel, für Innensechskant-Schrauben.....	50
Bithalter, Vierkantantrieb, für Bits mit Sechskant Form C.....	51
Bithalter, Vierkantantrieb, für Bits mit Sechskant Form C, ROTACTION.....	51
Bithalter, Vierkantantrieb, für Bits mit Sechskant Form C mit Magnet.....	51
Bithalter, Vierkantantrieb, für Bits mit Sechskant Form C mit Magnet, ROTACTION.....	51
Verlängerung, Außenvierkant mit Stifftarretierung.....	52
Verlängerung, Außenvierkant mit Stifftarretierung, ROTACTION.....	52
Verlängerung, Außenvierkant mit Durchgangsbohrung.....	52
Schnellwechselfutter, für Vierkantantriebe.....	53
Schnellwechselfutter, für Vierkantantriebe, ROTACTION.....	53
Gelenk Adapter, Außenvierkant mit Stifftarretierung.....	53
Adapter, Außenvierkant mit Stifftarretierung.....	53
Adapter, Außenvierkant mit Durchgangsbohrung.....	54

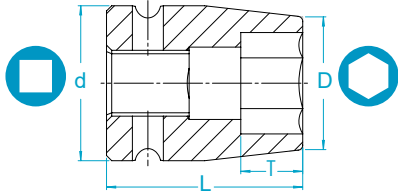

Steckschlüssel, Sechskant



		Ø Antrieb d mm	Ø Abtrieb D mm	Länge L mm	Tiefe T mm	Gewicht g	max. Drehmoment Nm	Bestell- nummer	Stift und O-Ring Ref.
Zoll	mm								
1/4	4	13	7,5	23	4	14	7,3	4027 1100 04	Z
1/4	4,5	13	8,1	23	4	14	8,8	4027 1100 45	Z
1/4	5	13	8,8	23	4	14	11	4027 1100 05	Z
1/4	5,5	13	9,4	23	4	16	12	4027 1100 55	Z
1/4	6	13	10	23	5	14	14	4027 1100 06	Z
1/4	7	13	11,3	23	5	14	19	4027 1100 07	Z
1/4	7	13	11,3	48	7	30	19	4027 1103 07	Z
1/4	8	13	12,5	23	6	14	24	4027 1100 08	Z
1/4	8	13	12,5	48	8	32	24	4027 1103 08	Z
1/4	9	13	13,8	23	7	14	28	4027 1100 09	Z
1/4	10	13	15	23	7	14	34	4027 1100 10	Z
1/4	10	13	15	48	10	34	34	4027 1103 10	Z
1/4	11	13	16,3	23	8	15	40	4027 1100 11	Z
1/4	11	13	16,3	48	11	46	40	4027 1103 11	Z
1/4	12	13	17,5	23	8	18	46	4027 1100 12	Z
1/4	12	13	17,5	48	12	49	46	4027 1103 12	Z
1/4	13	13	18,8	23	8	19	48	4027 1100 13	Z
1/4	13	13	18,8	48	13	52	48	4027 1103 13	Z
1/4	14	13	20	23	9	19	48	4027 1100 14	Z
Zoll	Zoll								
1/4	5/32	13	7,5	23	4	20	7,3	4027 1100 99	Z
1/4	3/16	13	8,1	23	4	14	11	4027 1100 98	Z
1/4	7/32	13	9,4	23	4	16	13	4027 1100 97	Z
1/4	1/4	13	10	23	5	16	17	4027 1100 96	Z
1/4	9/32	13	11,3	23	5	16	20	4027 1100 94	Z
1/4	5/16	13	12,5	23	6	16	24	4027 1100 93	Z
1/4	11/32	13	13,8	23	7	14	27	4027 1100 92	Z
1/4	3/8	13	15	23	7	15	32	4027 1100 91	Z
1/4	13/32	13	15	23	7	15	37	4027 1100 89	Z
1/4	7/16	13	16,3	23	8	16	41	4027 1100 88	Z
1/4	1/2	13	18,8	23	8	19	48	4027 1100 86	Z
1/4	9/16	13	20	23	9	22	48	4027 1100 84	Z

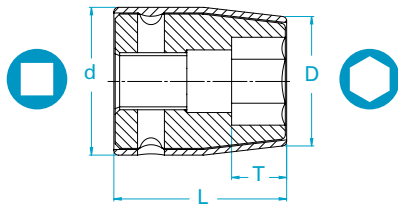

Steckschlüssel, Sechskant, ROTACTION

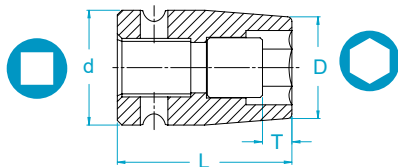

		Ø Antrieb d mm	Ø Abtrieb D mm	Länge L mm	Tiefe T mm	Gewicht g	max. Drehmoment Nm	Bestell- nummer	Steckschlüssel Abdeckung Ref.	Ersatzhülsen Bestellnummer*
Zoll	mm									
1/4	5	16	11,8	23	4	20	11	4027 1163 05	C16	4027 2982 02
1/4	6	16	13	23	5	20	14	4027 1163 06	C16	4027 2982 03
1/4	7	16	14,3	23	5	20	19	4027 1163 07	C16	4027 2982 01
1/4	7	16	14,3	48	7	27	19	4027 1142 07	C16	4027 2982 60
1/4	8	16	15,5	23	6	20	24	4027 1163 08	C16	4027 2982 04
1/4	8	16	15,5	48	8	33	24	4027 1142 08	C16	4027 2982 61
1/4	10	16	18	23	7	33	34	4027 1163 10	C16	4027 2982 05
1/4	10	16	18	48	10	41	34	4027 1142 10	C16	4027 2982 63
1/4	12	16	20,5	23	8	20	46	4027 1163 12	C16	4027 2982 06
1/4	13	16	21,8	23	8	20	48	4027 1163 13	C16	4027 2982 07
1/4	13	16	21,8	48	13	56	48	4027 1142 13	C16	4027 2982 62

Steckschlüssel, Sechskant mit Magnet





		Ø Antrieb d mm	Ø Abtrieb D mm	Länge L mm	Tiefe T mm	Gewicht g	max. Drehmoment Nm	Bestell- nummer	Stift und O-Ring Ref.
Zoll	mm								
1/4	4,5	13	8,1	23	2,1	13	8,8	4027 1105 45	Z
1/4	5	13	8,8	23	2,1	15	11	4027 1105 05	Z
1/4	5,5	13	9,4	23	2,1	15	12	4027 1105 55	Z
1/4	6	13	10	23	2,4	16	14	4027 1105 06	Z
1/4	7	13	11,3	23	2,8	18	19	4027 1105 07	Z
1/4	7	13	11,3	48	2,8	40	19	4027 1186 07	Z
1/4	8	13	12,5	23	3,5	17	24	4027 1105 08	Z
1/4	8	13	12,5	48	3,5	40	24	4027 1186 08	Z
1/4	9	13	13,8	23	3,8	18	28	4027 1105 09	Z
1/4	10	13	15	23	4,2	18	34	4027 1105 10	Z
1/4	10	13	15	48	4,2	50	34	4027 1186 10	Z
1/4	11	13	16,3	23	4,9	21	40	4027 1105 11	Z
1/4	12	13	17,5	25	5,6	21	46	4027 1105 12	Z
1/4	13	13	18,8	25	6	21	48	4027 1105 13	Z
1/4	13	13	18,8	48	6	79	48	4027 1186 13	Z
Zoll	Zoll								
1/4	3/16	13	8,1	23	2,1	15	11	4027 1105 98	Z
1/4	1/4	13	10	23	2,4	18	17	4027 1105 96	Z
1/4	5/16	13	12,5	23	3,5	18	24	4027 1105 93	Z
1/4	11/32	13	13,8	23	3,8	19	27	4027 1105 92	Z
1/4	3/8	13	15	23	4,2	20	32	4027 1105 91	Z
1/4	7/16	13	16,3	23	4,9	21	41	4027 1105 88	Z
1/4	1/2	13	18,8	25	6	23	48	4027 1105 86	Z
1/4	9/16	13	20	25	6,4	24	48	4027 1105 84	Z

*Ersatzhülsen werden als 2er Satz mit Montageanleitung geliefert.

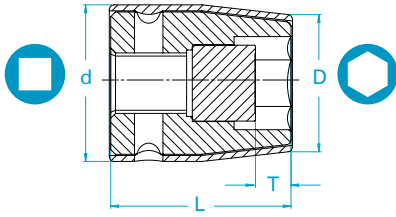

Steckschlüssel, Sechskant mit Magnet, ROTACTION



		Ø Antrieb d mm	Ø Abtrieb D mm	Länge L mm	Tiefe T mm	Gewicht g	max. Drehmoment Nm	Bestell- nummer	Steckschlüssel Abdeckung Ref.	Ersatzhülsen Bestellnummer*
Zoll	mm									
1/4	7	16	14,3	23	2,8	19	19	4027 1160 07	C16	4027 2982 20
1/4	7	16	14,3	48	2,8	33	19	4027 1185 07	C16	4027 2983 97
1/4	8	16	15,5	23	3,5	20	24	4027 1160 08	C16	4027 2982 21
1/4	8	16	15,5	48	3,5	40	24	4027 1185 08	C16	4027 2983 98
1/4	10	16	18	23	4,2	24	34	4027 1160 10	C16	4027 2982 22
1/4	10	16	18	48	4,2	53	34	4027 1185 10	C16	4027 2983 99
1/4	13	16	21,8	25	6	31	48	4027 1160 13	C16	4027 2982 23
1/4	13	16	21,8	48	6	84	48	4027 1185 13	C16	4027 2984 00

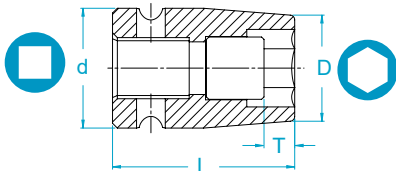

Steckschlüssel, Sechskant mit Magnet, für selbstschneidende Schrauben

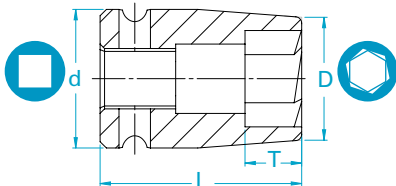

		Ø Antrieb d mm	Ø Abtrieb D mm	Länge L mm	Tiefe T mm	Gewicht g	max. Drehmoment Nm	Bestell- nummer	Stift und O-Ring Ref.
Zoll	mm								
1/4	5,5	13	9,7	23	2,1	16	12	4027 1106 55	Z
1/4	6	13	10,3	23	2,4	18	14	4027 1106 06	Z
1/4	7	13	11,6	23	2,8	16	19	4027 1106 07	Z
1/4	8	13	12,8	25	3,5	18	24	4027 1106 08	Z
1/4	10	13	15,3	28	4,2	20	34	4027 1106 10	Z
Zoll	Zoll								
1/4	1/4	13	10,3	23	2,4	16	17	4027 1106 96	Z
1/4	5/16	13	12,8	25	3,5	18	24	4027 1106 93	Z
1/4	3/8	13	15,3	28	4,2	20	32	4027 1106 91	Z
1/4	7/16	13	16,6	29	4,9	27	41	4027 1106 88	Z
1/4	1/2	13	19,1	30	6	23	48	4027 1106 86	Z

Steckschlüssel, Sechskant mit Einführschrägen





		Ø Antrieb d mm	Ø Abtrieb D mm	Länge L mm	Tiefe T mm	Gewicht g	max. Drehmoment Nm	Bestell- nummer	Stift und O-Ring Ref.
Zoll	mm								
1/4	10	13	15	23	8	19	34	4027 1118 10	Z
1/4	13	13	18,8	23	9	20	48	4027 1118 13	Z

*Ersatzhülsen werden als 2er Satz mit Montageanleitung geliefert.

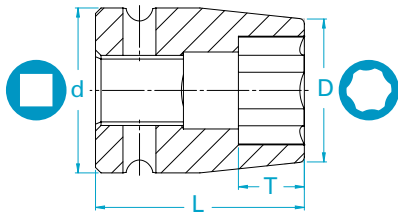

Steckschlüssel, Surface Drive



		Ø Antrieb d mm	Ø Abtrieb D mm	Länge L mm	Tiefe T mm	Gewicht g	max. Drehmoment Nm	Bestell- nummer	Stift und O-Ring Ref.
Zoll	mm								
1/4	6	13	10	23	5	14	14	4027 1108 06	Z
1/4	7	13	11,3	23	5	15	19	4027 1108 07	Z
1/4	8	13	12,5	23	6	16	24	4027 1108 08	Z
1/4	9	13	13,8	23	7	14	28	4027 1108 09	Z
1/4	10	13	15	23	7	14	34	4027 1108 10	Z
1/4	11	13	16,3	23	8	17	40	4027 1108 11	Z
1/4	12	13	17,5	23	8	17	46	4027 1108 12	Z
1/4	13	13	18,8	23	8	19	48	4027 1108 13	Z

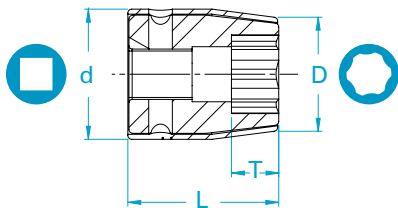

Steckschlüssel, Surface Drive, ROTACTION

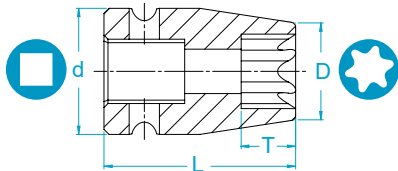

		Ø Antrieb d mm	Ø Abtrieb D mm	Länge L mm	Tiefe T mm	Gewicht g	max. Drehmoment Nm	Bestell- nummer	Steckschlüssel Abdeckung Ref.	Ersatzhülsen Bestellnummer*
Zoll	mm									
1/4	7	16	14,3	23	5	20	19	4027 1111 07	C16	4027 2982 24
1/4	8	16	15,5	23	6	21	24	4027 1111 08	C16	4027 2982 25
1/4	10	16	18	23	7	20	34	4027 1111 10	C16	4027 2981 82
1/4	13	16	18,8	23	8	25	48	4027 1111 13	C16	4027 2982 26

Steckschlüssel, für Torx®-Schrauben



		Ø Antrieb d mm	Ø Abtrieb D mm	Länge L mm	Tiefe T mm	Gewicht g	max. Drehmoment Nm	Bestell- nummer	Stift und O-Ring Ref.
Zoll									
1/4	E4	13	6,6	23	3,6	14	4,1	4027 1120 04	Z
1/4	E5	13	7,7	23	4,2	15	7,3	4027 1120 05	Z
1/4	E6	13	8,7	23	4,4	16	10	4027 1120 06	Z
1/4	E7	13	9,2	23	5,6	15	15	4027 1120 07	Z
1/4	E8	13	9,7	23	5,8	15	28	4027 1120 08	Z
1/4	E10	13	12,2	23	7,2	15	48	4027 1120 10	Z

*Ersatzhülsen werden als 2er Satz mit Montageanleitung geliefert.

Torx®, Torx Plus® sind eingetragene Warenzeichen von Acument Intellectual Properties, LLC.

Steckschlüssel, für Torx®-Schrauben, ROTACTION

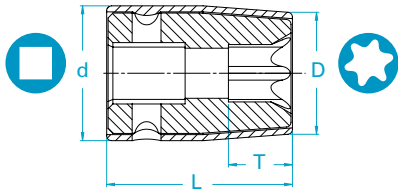

		Ø Antrieb d mm	Ø Abtrieb D mm	Länge L mm	Tiefe T mm	Gewicht g	max. Drehmoment Nm	Bestell- nummer	Steckschlüssel Abdeckung Ref.	Ersatzhülsen Bestellnummer*
Zoll										
1/4	E6	16	11,7	23	4,4	17	10	4027 1164 06	C16	4027 2982 41
1/4	E7	16	12,2	23	5,6	16	15	4027 1164 07	C16	4027 2982 42
1/4	E8	16	12,7	23	5,8	16	28	4027 1164 08	C16	4027 2982 43
1/4	E10	16	15,2	23	7,2	20	48	4027 1164 10	C16	4027 2981 83

Steckschlüssel, für Torx®-Schrauben mit Magnet

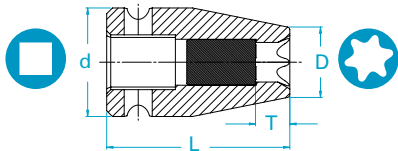

Vierkanttrieb
1/4"

		Ø Antrieb d mm	Ø Abtrieb D mm	Länge L mm	Tiefe T mm	Gewicht g	max. Drehmoment Nm	Bestell- nummer	Stift und O-Ring Ref.
Zoll									
1/4	E6	13	8,7	23	4	10	10	4027 1180 06	Z
1/4	E7	13	9,2	23	4,5	10	15	4027 1180 07	Z
1/4	E8	13	9,7	23	5,5	10	28	4027 1180 08	Z
1/4	E10	13	12,2	23	6	12	48	4027 1180 10	Z

Steckschlüssel, für Torx®-Schrauben mit Magnet, ROTACTION

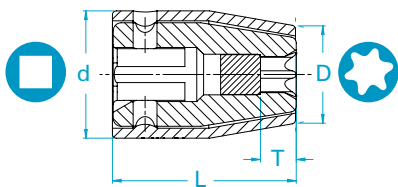



		Ø Antrieb d mm	Ø Abtrieb D mm	Länge L mm	Tiefe T mm	Gewicht g	max. Drehmoment Nm	Bestell- nummer	Steckschlüssel Abdeckung Ref.	Ersatzhülsen Bestellnummer*
Zoll										
1/4	E6	16	11,7	23	4	16	10	4027 1180 56	C16	4027 2983 50
1/4	E7	16	12,2	23	4,5	16	15	4027 1180 57	C16	4027 2983 51
1/4	E8	16	12,7	23	5,5	16	28	4027 1180 58	C16	4027 2983 52
1/4	E10	16	15,2	23	6	18	48	4027 1180 60	C16	4027 2983 53

*Ersatzhülsen werden als 2er Satz mit Montageanleitung geliefert.

Torx®, Torx Plus® sind eingetragene Warenzeichen von Acument Intellectual Properties, LLC.

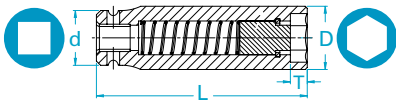
Steckschlüssel, Sechskant mit federndem Magnet*





		Ø Antrieb d mm	Ø Abtrieb D mm	Länge L mm	Tiefe T mm	Gewicht g	max. Drehmoment Nm	Bestell- nummer	Stift und O-Ring Ref.
Zoll	mm								
1/4	5,5	13	9,4	48	2,5	24	12	4027 1107 55	Z
1/4	7	13	11,3	48	3,5	34	19	4027 1107 07	Z
1/4	8	13	12,5	48	4	30	24	4027 1107 08	Z
1/4	10	13	15	48	4,5	34	34	4027 1107 10	Z
1/4	12	13	17,5	48	6	49	46	4027 1107 12	Z
1/4	13	13	18,8	48	6,5	52	48	4027 1107 13	Z

* Federweg ca. 20 mm

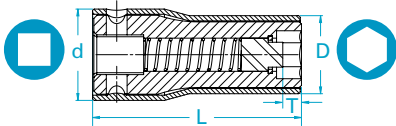
Steckschlüssel, Sechskant mit federndem Magnet*, ROTACTION





		Ø Antrieb d mm	Ø Abtrieb D mm	Länge L mm	Tiefe T mm	Gewicht g	max. Drehmoment Nm	Bestell- nummer	Steckschlüssel Abdeckung Ref.	Ersatzhülsen Bestellnummer*
Zoll	mm									
1/4	7	16	14,3	48	3,5	35	19	4027 1162 07	C16	4027 2983 70
1/4	8	16	15,5	48	4	41	24	4027 1162 08	C16	4027 2983 71
1/4	10	16	18	48	4,5	48	34	4027 1162 10	C16	4027 2983 73
1/4	13	16	21,8	48	6,5	71	48	4027 1162 13	C16	4027 2983 72

* Federweg ca. 20 mm

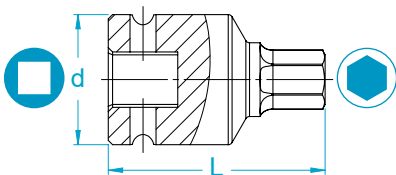
Bit Steckschlüssel, für Innensechskant-Schrauben



		Ø Antrieb d mm	Länge L mm	Gewicht g	max. Drehmoment Nm	Bestell- nummer	Stift und O-Ring Ref.
Zoll	mm						
1/4	3	13	25	14	5,3	4027 1123 03	Z
1/4	4	13	25	14	13	4027 1123 04	Z
1/4	5	13	25	13	25	4027 1123 05	Z
1/4	6	13	28	17	43	4027 1123 06	Z
1/4	7	13	28	18	48	4027 1123 07	Z
1/4	8	13	28	16	48	4027 1123 08	Z

*Ersatzhülsen werden als 2er Satz mit Montageanleitung geliefert.

Bithalter, Vierkanttrieb, für Bits mit Sechskant Form C

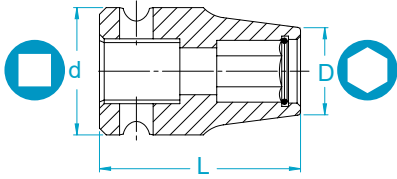

		Ø Antrieb d mm	Ø Abtrieb D mm	Länge L mm	Gewicht g	Bestell- nummer	Stift und O-Ring Ref.
Zoll	Zoll						
1/4	1/4	13	11	25	16	4027 1135 00	Z

Bithalter, Vierkanttrieb, für Bits mit Sechskant Form C, ROTACTION

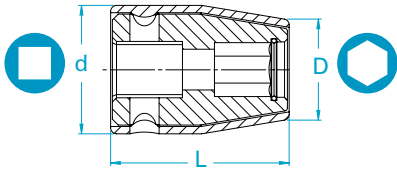

		Ø Antrieb d mm	Ø Abtrieb D mm	Länge L mm	Gewicht g	Bestell- nummer	Steckschlüssel Abdeckung Ref.	Ersatzhülsen Bestellnummer*
Zoll	Zoll							
1/4	1/4	16	14	25	20	4027 1135 70	C16	4027 2984 80

Vierkanttrieb
1/4"

Bithalter, Vierkanttrieb, für Bits mit Sechskant Form C mit Magnet



		Ø Antrieb d mm	Ø Abtrieb D mm	Länge L mm	Gewicht g	Bestell- nummer	Stift und O-Ring Ref.
Zoll	Zoll						
1/4	1/4	13	11	44	30	4027 2000 80	Z

Bithalter, Vierkanttrieb, für Bits mit Sechskant Form C mit Magnet, ROTACTION

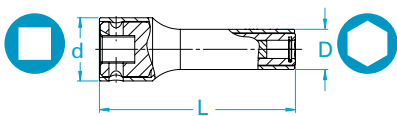



		Ø Antrieb d mm	Ø Abtrieb D mm	Länge L mm	Gewicht g	Bestell- nummer	Steckschlüssel Abdeckung Ref.	Ersatzhülsen Bestellnummer*
Zoll	Zoll							
1/4	1/4	16	14	44	35	4027 1135 80	C16	4027 2984 88

*Ersatzhülsen werden als 2er Satz mit Montageanleitung geliefert.

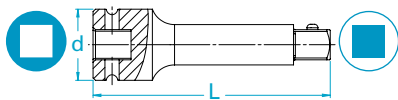

Verlängerung, Außenvierkant mit Stiftarretierung



		Ø Antrieb d mm	Länge L mm	Gewicht g	Bestell- nummer	Stift und O-Ring Ref.
Zoll	Zoll					
1/4	1/4	13	55	26	4027 1134 00	Z
1/4	1/4	13	75	45	4027 1134 01	Z
1/4	1/4	13	100	69	4027 1134 02	Z
1/4	1/4	13	125	93	4027 1134 03	Z
1/4	1/4	13	150	117	4027 1134 04	Z

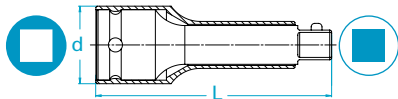

Verlängerung, Außenvierkant mit Stiftarretierung, ROTACTION

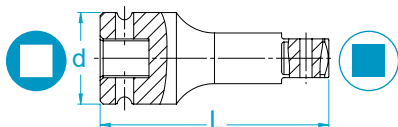

		Ø Antrieb d mm	Länge L mm	Gewicht g	Bestell- nummer	Steckschlüssel Abdeckung Ref.	Ersatzhülsen Bestellnummer*
Zoll	Zoll						
1/4	1/4	16	55	31	4027 1134 20	C16	4027 2984 32
1/4	1/4	16	75	52	4027 1134 21	C16	4027 2984 33
1/4	1/4	16	100	79	4027 1134 22	C16	4027 2984 34

Verlängerung, Außenvierkant mit Durchgangsbohrung



		Ø Antrieb d mm	Länge L mm	Gewicht g	Bestell- nummer	Stift und O-Ring Ref.
Zoll	Zoll					
1/4	1/4	13	55	26	4027 1134 10	Z
1/4	1/4	13	75	45	4027 1134 11	Z
1/4	1/4	13	100	69	4027 1134 12	Z
1/4	1/4	13	125	93	4027 1134 13	Z
1/4	1/4	13	150	117	4027 1134 14	Z

*Ersatzhülsen werden als 2er Satz mit Montageanleitung geliefert.

Schnellwechselfutter, für Vierkantantriebe

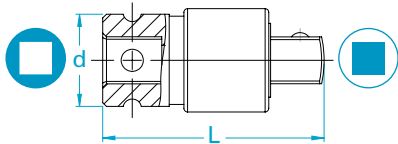

		Ø Antrieb d mm	Länge L mm	Gewicht g	Bestell- nummer	Stift und O-Ring Ref.
Zoll	Zoll	13	25	30	4027 1136 10	Z
1/4	1/4					

Schnellwechselfutter, für Vierkantantriebe, ROTACTION

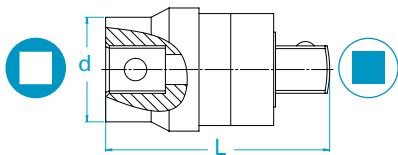

		Ø Antrieb d mm	Länge L mm	Gewicht g	Bestell- nummer	Steckschlüssel Abdeckung Ref.
Zoll	Zoll	16	35	30	4027 1136 30	C16
1/4	1/4					

Vierkantantrieb
1/4"

Gelenk Adapter, Außenvierkant mit Stiftarretierung

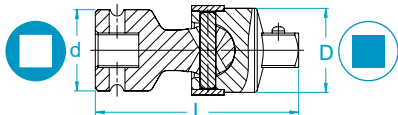

		Ø Antrieb d mm	Ø Abtrieb D mm	Länge L mm	Gewicht g	Bestell- nummer	Stift und O-Ring Ref.
Zoll	Zoll	13	16	39	30	4027 1135 40	Z
1/4	1/4						

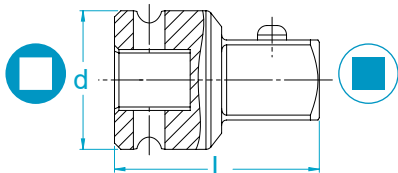

Adapter, Außenvierkant mit Stiftarretierung

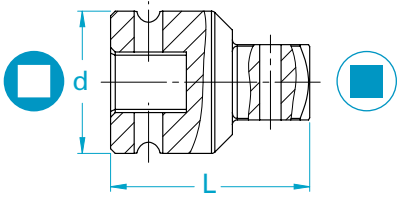

		Ø Antrieb d mm	Länge L mm	Gewicht g	Bestell- nummer	Stift und O-Ring Ref.
Zoll	Zoll	13	22	16	4027 1135 31	Z
1/4	3/8					

Adapter, Außenvierkant mit Durchgangsbohrung



		Ø Antrieb d mm	Länge L mm	Gewicht g	Bestell- nummer	Stift und O-Ring Ref.
Zoll	Zoll					
1/4	3/8	13	22	15	4027 1135 21	Z

Vierkantantrieb 3/8"



Vierkantantrieb 3/8"55

Steckschlüssel, Sechskant.....	56
Steckschlüssel, Sechskant, ROTACTION.....	57
Steckschlüssel, dünnwandig, Sechskant.....	58
Steckschlüssel, dünnwandig, Sechskant, ROTACTION.....	59
Steckschlüssel, Sechskant, geführt.....	59
Steckschlüssel, Sechskant mit Magnet.....	60
Steckschlüssel, Sechskant mit Magnet, ROTACTION.....	60
Steckschlüssel, Sechskant mit Magnet, für selbstschneidende Schrauben.....	61
Steckschlüssel, dünnwandig, Sechskant mit Magnet.....	61
Steckschlüssel, dünnwandig, Sechskant mit Magnet, ROTACTION.....	62
Steckschlüssel, Sechskant mit federndem Magnet.....	62
Steckschlüssel, Sechskant mit federndem Magnet, ROTACTION.....	63
Steckschlüssel, Sechskant mit Einführschrägen.....	63
Steckschlüssel, Surface Drive.....	64
Steckschlüssel, Surface Drive, ROTACTION.....	65
Steckschlüssel, Surface Drive, LongLife.....	65
Steckschlüssel, Surface Drive, geführt.....	66
Steckschlüssel, Doppelsechskant.....	66
Steckschlüssel, dünnwandig, Doppelsechskant.....	67
Steckschlüssel, für Torx®-Schrauben.....	67
Steckschlüssel, für Torx®-Schrauben, ROTACTION.....	68
Steckschlüssel, für Torx®-Schrauben mit Magnet.....	68
Steckschlüssel, für Torx®-Schrauben mit Magnet, ROTACTION.....	68
Steckschlüssel, für TorxPlus®-Schrauben.....	69
Gelenkschlüssel, Sechskant.....	69
Bit Steckschlüssel, für Innensechskant-Schrauben.....	70
Bit Steckschlüssel, für Innensechskant-Schrauben, geführt.....	70
Bit Steckschlüssel, für Torx®-Schrauben.....	70
Bit Steckschlüssel, für Torx®-Schrauben, ROTACTION.....	71
Bit Steckschlüssel, für Torx®-Schrauben mit Ringmagnet, ROTACTION.....	71
Bit Steckschlüssel, für Torx®-Schrauben, geführt.....	72
Bit Steckschlüssel, für TorxPlus®-Schrauben mit Ringmagnet, ROTACTION.....	72
Bit Steckschlüssel, für XZN-Schrauben.....	72

Bithalter, Vierkantantrieb, für Bits mit Sechskant Form C.....	73
Bithalter, Vierkantantrieb, für Bits mit Sechskant Form C, ROTACTION.....	73
Bithalter, Vierkantantrieb, für Bits mit Sechskant Form C mit Magnet.....	73
Bithalter, Vierkantantrieb, für Bits mit Sechskant Form C mit Magnet, ROTACTION.....	73
Bithalter, Vierkantantrieb, für 11 mm Sechskant-Bits.....	74
Bithalter, Vierkantantrieb, für 11 mm Sechskant-Bits, ROTACTION.....	74
Bithalter, Vierkantantrieb, für 11 mm Sechskant-Bits, geführt.....	74
Bits, mit 11 mm Sechskantantrieb, für Innensechskant-Schrauben.....	75
Bits, mit 11 mm Sechskantantrieb, für Torx®-Schrauben.....	75
Bits, mit 11 mm Sechskantantrieb, für XZN-Schrauben.....	75
Verlängerung, Außenvierkant mit Stiftarretierung.....	76
Verlängerung, Außenvierkant mit Stiftarretierung, ROTACTION.....	76
Verlängerung, Außenvierkant mit Kugelarretierung.....	76
Verlängerung, Außenvierkant mit Kugelarretierung, ROTACTION.....	77
Verlängerung, Außenvierkant mit Durchgangsbohrung.....	77
Verlängerung, Außenvierkant mit Durchgangsbohrung, geführt.....	77
Schnellwechselfutter, für Vierkantantriebe.....	78
Schnellwechselfutter, für Vierkantantriebe, ROTACTION.....	78
Gelenk Adapter, Außenvierkant mit Stiftarretierung.....	78
Wobble Adapter mit Feder.....	78
Adapter, Außenvierkant mit Stiftarretierung.....	79
Adapter, Außenvierkant mit Durchgangsbohrung.....	79
Schnellwechselfutter, Vierkantantrieb, für Bits mit Sechskant Form C.....	79
Schnellwechselfutter, Vierkantantrieb, für Bits mit Sechskant Form E.....	79
Schnellwechselfutter, Vierkantantrieb, für Bits mit Sechskant Form E, ROTACTION.....	80
Schnellwechselfutter, Vierkantantrieb, für Bits mit Sechskant Form E, geführt.....	80

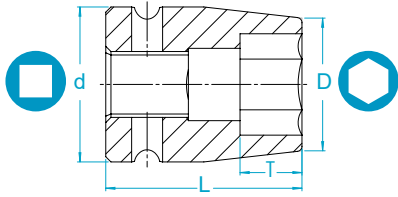

Steckschlüssel, Sechskant

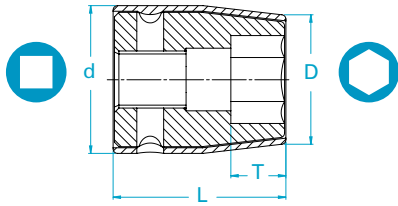

		Ø Antrieb d mm	Ø Abtrieb D mm	Länge L mm	Tiefe T mm	Gewicht g	max. Drehmoment Nm	Bestell- nummer	Stift und O-Ring Ref.
Zoll	mm								
3/8	6	19	10,8	32	5	40	17	4027 1200 06	Y
3/8	7	19	12	32	5	40	23	4027 1200 07	Y
3/8	8	19	13,3	32	6	40	32	4027 1200 08	Y
3/8	8	19	13,3	80	8	82	32	4027 1203 08	Y
3/8	9	19	14,5	32	7	40	42	4027 1200 09	Y
3/8	9	19	14,5	80	9	90	42	4027 1203 09	Y
3/8	10	19	15,8	32	7	40	54	4027 1200 10	Y
3/8	10	19	15,8	80	10	94	54	4027 1203 10	Y
3/8	11	19	17	32	8	41	67	4027 1200 11	Y
3/8	11	19	17	80	11	110	67	4027 1203 11	Y
3/8	12	19	18,3	32	9	43	82	4027 1200 12	Y
3/8	12	19	18,3	80	12	111	82	4027 1203 12	Y
3/8	13	22	19,5	32	10	56	99	4027 1200 13	X
3/8	13	22	19,5	80	13	138	99	4027 1203 13	X
3/8	14	22	20,8	32	10	58	118	4027 1200 14	X
3/8	14	22	20,8	80	14	148	118	4027 1203 14	X
3/8	15	22	22	32	11	57	151	4027 1200 15	X
3/8	15	22	22	80	15	157	151	4027 1203 15	X
3/8	16	22	23,3	32	11	57	182	4027 1200 16	X
3/8	16	22	23,3	80	16	156	182	4027 1203 16	X
3/8	17	22	24,5	32	12	60	196	4027 1200 17	X
3/8	17	22	24,5	80	17	168	196	4027 1203 17	X
3/8	18	22	25,8	32	12	62	196	4027 1200 18	X
3/8	18	22	25,8	80	18	190	196	4027 1203 18	X
3/8	19	22	27	32	12	68	196	4027 1200 19	X
3/8	19	22	27	80	19	192	196	4027 1203 19	X
3/8	21	22	29,5	32	12	71	196	4027 1200 21	X
3/8	21	22	29,5	80	21	226	196	4027 1203 21	X
3/8	22	22	30,8	32	13	74	196	4027 1200 22	X
3/8	22	22	30,8	80	22	231	196	4027 1203 22	X
3/8	24	22	33,3	32	13	80	196	4027 1200 24	X
Zoll	Zoll								
3/8	5/16	19	13,3	32	6	40	32	4027 1200 93	Y
3/8	5/16	19	13,3	80	8	82	32	4027 1203 93	Y
3/8	3/8	19	15,8	32	7	40	49	4027 1200 91	Y
3/8	3/8	19	15,8	80	10	94	49	4027 1203 91	Y
3/8	13/32	19	15,8	32	7	40	59	4027 1200 89	Y
3/8	7/16	19	17	32	8	41	70	4027 1200 88	Y
3/8	7/16	19	17	80	11	110	70	4027 1203 88	Y
3/8	15/32	19	18,3	32	9	43	82	4027 1200 87	Y
3/8	1/2	22	19,5	32	10	58	95	4027 1200 86	X
3/8	1/2	22	19,5	80	13	138	95	4027 1203 86	X
3/8	9/16	22	20,8	32	10	56	129	4027 1200 84	X
3/8	9/16	22	20,8	80	14	148	129	4027 1203 84	X
3/8	5/8	22	23,3	32	11	57	180	4027 1200 83	X
3/8	5/8	22	23,3	80	16	154	180	4027 1203 83	X
3/8	11/16	22	24,5	32	12	60	196	4027 1200 82	X
3/8	11/16	22	24,5	80	17	168	196	4027 1203 82	X
3/8	3/4	22	27	32	12	68	196	4027 1200 81	X
3/8	3/4	22	27	80	19	192	196	4027 1203 81	X
3/8	13/16	22	29,5	32	12	71	196	4027 1200 79	X
3/8	13/16	22	29,5	80	21	226	196	4027 1203 79	X
3/8	7/8	22	30,8	32	13	72	196	4027 1200 78	X
3/8	7/8	22	30,8	80	22	231	196	4027 1203 78	X

Steckschlüssel, Sechskant, ROTACTION





		Ø Antrieb d mm	Ø Abtrieb D mm	Länge L mm	Tiefe T mm	Gewicht g	max. Drehmoment Nm	Bestell- nummer	Steckschlüssel Abdeckung Ref.	Ersatzhülsen Bestellnummer*
Zoll	mm									
3/8	7	22	15	32	5	40	23	4027 1263 07	C22	4027 2982 00
3/8	8	22	16,3	32	6	42	32	4027 1263 08	C22	4027 2980 59
3/8	8	22	16,3	80	8	87	32	4027 1244 08	C22	4027 2980 95
3/8	10	22	18,8	32	7	42	54	4027 1263 10	C22	4027 2980 60
3/8	10	22	18,8	80	10	99	54	4027 1244 10	C22	4027 2980 96
3/8	11	22	20	32	8	40	67	4027 1263 11	C22	4027 2981 87
3/8	12	22	21,3	32	9	50	82	4027 1263 12	C22	4027 2981 88
3/8	12	22	21,3	80	12	107	82	4027 1244 12	C22	4027 2982 64
3/8	13	25	22,5	32	10	59	99	4027 1263 13	C25	4027 2980 61
3/8	13	25	22,5	80	13	145	99	4027 1244 13	C25	4027 2980 97
3/8	14	25	23,8	32	10	60	118	4027 1263 14	C25	4027 2981 89
3/8	14	25	23,8	80	14	152	118	4027 1244 14	C25	4027 2982 65
3/8	15	25	25	32	11	60	151	4027 1263 15	C25	4027 2981 90
3/8	15	25	25	80	15	146	151	4027 1244 15	C25	4027 2982 70
3/8	16	25	26,3	32	11	62	182	4027 1263 16	C25	4027 2980 62
3/8	16	25	26,2	80	16	163	182	4027 1244 16	C25	4027 2980 98
3/8	17	25	27,5	32	12	66	196	4027 1263 17	C25	4027 2980 63
3/8	17	25	27,5	80	17	167	196	4027 1244 17	C25	4027 2981 87
3/8	18	25	28,8	32	12	69	196	4027 1263 18	C25	4027 2980 64
3/8	18	25	28,8	80	18	179	196	4027 1244 18	C25	4027 2982 66
3/8	19	25	30	32	12	72	196	4027 1263 19	C25	4027 2980 65
3/8	19	25	30	80	19	192	196	4027 1244 19	C25	4027 2982 67
3/8	21	25	32,5	32	12	77	196	4027 1263 21	C25	4027 2980 66
3/8	21	25	32,5	80	21	215	196	4027 1244 21	C25	4027 2982 68
3/8	22	25	33,8	32	13	80	196	4027 1263 22	C25	4027 2981 91
3/8	22	25	33,8	80	22	232	196	4027 1244 22	C25	4027 2982 69

*Ersatzhülsen werden als 2er Satz mit Montageanleitung geliefert.

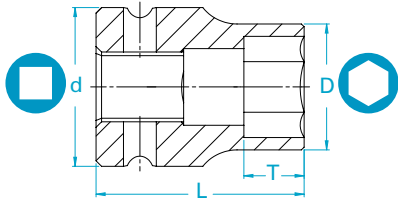

Steckschlüssel, dünnwandig, Sechskant



		Ø Antrieb d mm	Ø Abtrieb D mm	Länge L mm	Tiefe T mm	Gewicht g	max. Drehmoment Nm	Bestell- nummer	Stift und O-Ring Ref.
Zoll	mm								
3/8	8	18,5	12,3	32	6	33	32	4027 1201 08	Y
3/8	8	18,5	12,3	50	8	40	32	4027 1202 08	Y
3/8	8	18,5	12,3	80	8	68	32	4027 1204 08	Y
3/8	9	18,5	13,5	32	7	32	42	4027 1201 09	Y
3/8	9	18,5	13,5	50	9	43	42	4027 1202 09	Y
3/8	9	18,5	13,5	80	9	70	42	4027 1204 09	Y
3/8	10	18,5	14,8	32	7	34	54	4027 1201 10	Y
3/8	10	18,5	14,8	50	10	46	54	4027 1202 10	Y
3/8	10	18,5	14,8	80	10	72	54	4027 1204 10	Y
3/8	11	18,5	16	32	8	35	67	4027 1201 11	Y
3/8	11	18,5	16	50	11	49	67	4027 1202 11	Y
3/8	11	18,5	16	80	11	80	67	4027 1204 11	Y
3/8	12	18,5	17,3	32	9	36	82	4027 1201 12	Y
3/8	12	18,5	17,3	50	12	53	82	4027 1202 12	Y
3/8	12	18,5	17,3	80	12	85	82	4027 1204 12	Y
3/8	13	21,5	18,5	32	10	45	99	4027 1201 13	X
3/8	13	21,5	18,5	50	13	67	99	4027 1202 13	X
3/8	13	21,5	18,5	80	13	98	99	4027 1204 13	X
3/8	14	21,5	19,8	32	10	49	118	4027 1201 14	X
3/8	14	21,5	19,8	50	14	70	118	4027 1202 14	X
3/8	14	21,5	19,8	80	14	109	118	4027 1204 14	X
3/8	15	21,5	21	32	11	49	138	4027 1201 15	X
3/8	15	21,5	21	50	15	75	138	4027 1202 15	X
3/8	15	21,5	21	80	15	122	138	4027 1204 15	X
3/8	16	21,5	22,3	32	11	51	157	4027 1201 16	X
3/8	16	21,5	22,3	50	16	78	157	4027 1202 16	X
3/8	16	21,5	22,3	80	16	130	157	4027 1204 16	X
3/8	17	21,5	23,5	32	12	54	157	4027 1201 17	X
3/8	17	21,5	23,5	50	17	82	157	4027 1202 17	X
3/8	17	21,5	23,5	80	17	136	157	4027 1204 17	X
3/8	18	21,5	24,8	32	12	57	157	4027 1201 18	X
3/8	18	21,5	24,8	50	18	86	157	4027 1202 18	X
3/8	18	21,5	24,8	80	18	145	157	4027 1204 18	X
3/8	19	21,5	26	32	12	60	157	4027 1201 19	X
3/8	19	21,5	26	50	19	93	157	4027 1202 19	X
3/8	19	21,5	26	80	19	155	157	4027 1204 19	X
3/8	21	21,5	28,5	32	12	72	157	4027 1201 21	X
3/8	21	21,5	28,5	50	21	104	157	4027 1202 21	X
3/8	21	21,5	28,5	80	21	181	157	4027 1204 21	X
3/8	22	21,5	29,8	32	13	74	157	4027 1201 22	X
3/8	22	21,5	29,8	50	22	108	157	4027 1202 22	X
3/8	22	21,5	29,8	80	22	190	157	4027 1204 22	X
3/8	24	21,5	32,3	32	13	75	157	4027 1201 24	X
3/8	24	21,5	32,3	50	24	120	157	4027 1202 24	X
Zoll	Zoll								
3/8	5/16	18,5	12,3	32	6	31	32	4027 1201 93	Y
3/8	5/16	18,5	12,3	80	8	68	32	4027 1204 93	Y
3/8	3/8	18,5	14,8	32	7	34	49	4027 1201 91	Y
3/8	3/8	18,5	14,8	80	10	72	49	4027 1204 91	Y
3/8	7/16	18,5	16	32	8	35	70	4027 1201 88	Y
3/8	7/16	18,5	16	80	11	80	70	4027 1204 88	Y
3/8	1/2	21,5	18,5	32	10	43	95	4027 1201 86	X
3/8	1/2	21,5	18,5	80	13	100	95	4027 1204 86	X
3/8	9/16	21,5	19,8	32	10	49	125	4027 1201 84	X
3/8	9/16	21,5	19,8	80	14	110	125	4027 1204 84	X
3/8	5/8	21,5	22,3	32	11	51	157	4027 1201 83	X
3/8	5/8	21,5	22,3	80	16	130	157	4027 1204 83	X
3/8	11/16	21,5	23,5	32	12	54	157	4027 1201 82	X
3/8	11/16	21,5	23,5	80	17	136	157	4027 1204 82	X
3/8	3/4	21,5	26	32	12	60	157	4027 1201 81	X
3/8	3/4	21,5	26	80	19	155	157	4027 1204 81	X
3/8	13/16	21,5	28,5	32	12	70	157	4027 1201 79	X
3/8	13/16	21,5	28,5	80	21	181	157	4027 1204 79	X
3/8	7/8	21,5	29,8	32	13	74	157	4027 1201 78	X
3/8	7/8	21,5	29,8	80	22	190	157	4027 1204 78	X

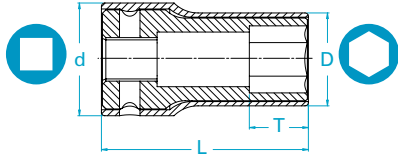

Steckschlüssel, dünnwandig, Sechskant, ROTACTION

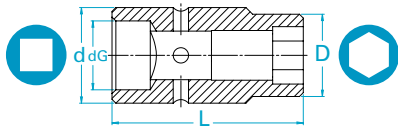

		Ø Antrieb d mm	Ø Abtrieb D mm	Länge L mm	Tiefe T mm	Gewicht g	max. Drehmoment Nm	Bestell- nummer	Steckschlüssel Abdeckung Ref.	Ersatzhülsen Bestellnummer*
Zoll	mm									
3/8	8	22	15,3	50	8	46	32	4027 1242 08	C22	4027 2980 91
3/8	10	22	17,8	50	10	50	54	4027 1242 10	C22	4027 2980 92
3/8	12	22	20,3	50	12	57	82	4027 1242 12	C22	4027 2982 44
3/8	13	25	21,5	50	13	71	99	4027 1242 13	C25	4027 2980 93
3/8	14	25	22,8	50	14	75	118	4027 1242 14	C25	4027 2982 45
3/8	15	25	24	50	15	79	138	4027 1242 15	C25	4027 2982 46
3/8	16	25	25,3	50	16	83	157	4027 1242 16	C25	4027 2980 94
3/8	17	25	26,5	50	17	88	157	4027 1242 17	C25	4027 2982 47
3/8	18	25	27,8	50	18	95	157	4027 1242 18	C25	4027 2982 48
3/8	19	25	29	50	19	100	157	4027 1242 19	C25	4027 2982 49
3/8	21	25	31,5	50	21	115	157	4027 1242 21	C25	4027 2982 50
3/8	22	25	32,8	50	22	123	157	4027 1242 22	C25	4027 2982 51

Steckschlüssel, Sechskant, geführt





		Ø Antrieb d mm	Ø Abtrieb D mm	Ø Führung d _g mm	Länge L mm	Tiefe T mm	Gewicht g	max. Drehmoment Nm	Bestell- nummer	Stift und O-Ring Ref.
Zoll	mm									
3/8	10	20	15	13	42	5	54	54	4026 4210 00	X
3/8	13	20	20	13	42	8	62	99	4026 4213 00	X
3/8	15	20	23,5	13	42	8,5	76	151	4026 4215 00	X
3/8	16	20	25	13	42	9	73	182	4026 4216 00	X
3/8	17	20	26	13	42	10	77	196	4026 4217 00	X
3/8	18	20	28	13	42	10	79	196	4026 4218 00	X
3/8	19	22	28	13	42	11	87	196	4026 4219 00	X
Zoll	Zoll									
3/8	1/2	20	20	13	42	8	61	95	4026 4212 00	X
3/8	9/16	20	22	13	42	8	54	129	4026 4214 00	X
3/8	3/4	22	28	13	42	11	87	196	4026 4219 00	X

*Ersatzhülsen werden als 2er Satz mit Montageanleitung geliefert.

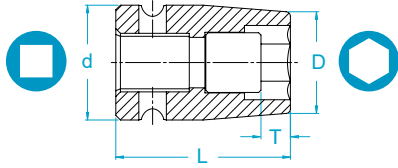
Steckschlüssel, Sechskant mit Magnet



		Ø Antrieb d mm	Ø Abtrieb D mm	Länge L mm	Tiefe T mm	Gewicht g	max. Drehmoment Nm	Bestell- nummer	Stift und O-Ring Ref.
Zoll	mm								
3/8	6	19	10,8	32	2,4	44	17	4027 1205 06	Y
3/8	7	19	12	32	2,8	45	23	4027 1205 07	Y
3/8	8	19	13,3	32	3,5	47	32	4027 1205 08	Y
3/8	9	19	14,5	32	3,8	46	42	4027 1205 09	Y
3/8	10	19	15,8	32	4,2	49	54	4027 1205 10	Y
3/8	11	19	17	32	4,9	52	67	4027 1205 11	Y
3/8	12	19	18,3	32	5,6	55	82	4027 1205 12	Y
3/8	13	22	19,5	32	6	70	99	4027 1205 13	X
3/8	14	22	20,8	32	6,4	76	118	4027 1205 14	X
3/8	15	22	22	32	6,8	76	151	4027 1205 15	X
3/8	16	22	23,3	32	7	88	182	4027 1205 16	X
3/8	17	22	24,5	32	7,5	95	196	4027 1205 17	X
3/8	18	22	25,8	32	7,8	105	196	4027 1205 18	X
3/8	19	22	27	32	8	116	196	4027 1205 19	X
3/8	21	22	29,5	32	8	125	196	4027 1205 21	X
3/8	22	22	30,8	32	9,5	135	196	4027 1205 22	X
Zoll	Zoll								
3/8	5/16	19	13,3	32	3,5	45	32	4027 1205 93	Y
3/8	3/8	19	15,8	32	4,2	49	49	4027 1205 91	Y
3/8	7/16	19	17	32	4,9	50	70	4027 1205 88	Y
3/8	1/2	22	19,5	32	6	70	95	4027 1205 86	X
3/8	9/16	22	20,8	32	6,4	74	129	4027 1205 84	X
3/8	5/8	22	23,3	32	7	88	180	4027 1205 83	X
3/8	11/16	22	24,5	32	7,5	95	196	4027 1205 82	X
3/8	3/4	22	27	32	8	116	196	4027 1205 81	X

Steckschlüssel, Sechskant mit Magnet, ROTACTION

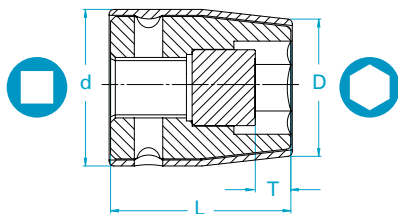



		Ø Antrieb d mm	Ø Abtrieb D mm	Länge L mm	Tiefe T mm	Gewicht g	max. Drehmoment Nm	Bestell- nummer	Steckschlüssel Abdeckung Ref.	Ersatzhülsen Bestellnummer*
Zoll	mm									
3/8	7	22	15	32	2,8	50	23	4027 1260 07	C22	4027 2982 08
3/8	8	22	16,3	32	3,5	47	32	4027 1260 08	C22	4027 2980 67
3/8	10	22	18,8	32	4,2	54	54	4027 1260 10	C22	4027 2980 68
3/8	12	22	21,3	32	5,6	52	82	4027 1260 12	C22	4027 2982 09
3/8	13	25	22,5	32	6	74	99	4027 1260 13	C25	4027 2980 69
3/8	14	25	23,8	32	6,4	71	118	4027 1260 14	C25	4027 2982 10
3/8	15	25	25	32	6,8	73	151	4027 1260 15	C25	4027 2982 11
3/8	16	25	26,3	32	7	100	182	4027 1260 16	C25	4027 2980 70
3/8	17	25	27,5	32	7,5	103	196	4027 1260 17	C25	4027 2982 12
3/8	18	25	28,8	32	7,8	108	196	4027 1260 18	C25	4027 2982 13
3/8	19	25	30	32	8	118	196	4027 1260 19	C25	4027 2982 14

*Ersatzhülsen werden als 2er Satz mit Montageanleitung geliefert.

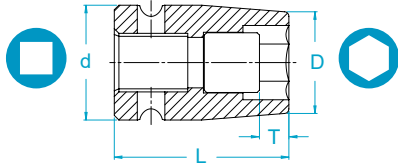
Steckschlüssel, Sechskant mit Magnet, für selbstschneidende Schrauben



		Ø Antrieb d mm	Ø Abtrieb D mm	Länge L mm	Tiefe T mm	Gewicht g	max. Drehmoment Nm	Bestell- nummer	Stift und O-Ring Ref.
Zoll	mm								
3/8	6	19	11,4	32	2,4	44	17	4027 1206 06	Y
3/8	7	19	12,8	32	2,8	44	23	4027 1206 07	Y
3/8	8	19	14,1	32	3,5	48	32	4027 1206 08	Y
3/8	10	19	16,6	33	4,2	55	54	4027 1206 10	Y
3/8	11	19	17,8	33	4,9	54	67	4027 1206 11	Y
3/8	12	19	18,9	34	5,6	62	82	4027 1206 12	Y
3/8	13	22	20,3	34	6	79	99	4027 1206 13	X
Zoll	Zoll								
3/8	1/4	19	11,4	32	2,4	44	20	4027 1206 96	Y
3/8	5/16	19	14,1	32	3,5	48	32	4027 1206 93	Y
3/8	3/8	19	16,6	33	4,2	54	49	4027 1206 91	Y
3/8	1/2	22	20,3	34	6	81	95	4027 1206 86	X

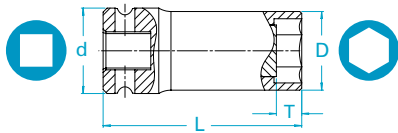

Steckschlüssel, dünnwandig, Sechskant mit Magnet



		Ø Antrieb d mm	Ø Abtrieb D mm	Länge L mm	Tiefe T mm	Gewicht g	max. Drehmoment Nm	Bestell- nummer	Stift und O-Ring Ref.
Zoll	mm								
3/8	7	18,5	11	50	2,8	50	23	4027 1286 07	Y
3/8	8	18,5	12,3	50	3,5	50	32	4027 1286 08	Y
3/8	10	18,5	14,8	50	4,2	60	54	4027 1286 10	Y
3/8	11	18,5	16	50	4,9	60	67	4027 1286 11	Y
3/8	12	18,5	17,3	50	5,6	70	82	4027 1286 12	Y
3/8	13	21,5	18,5	50	6	90	99	4027 1286 13	X
3/8	14	21,5	19,8	50	6,4	95	118	4027 1286 14	X
3/8	15	21,5	21	50	6,8	100	138	4027 1286 15	X
3/8	16	21,5	22,3	50	7	120	157	4027 1286 16	X
3/8	17	21,5	23,5	50	7,5	130	157	4027 1286 17	X
3/8	18	21,5	24,8	50	7,8	140	157	4027 1286 18	X
3/8	19	21,5	26	50	8	150	157	4027 1286 19	X

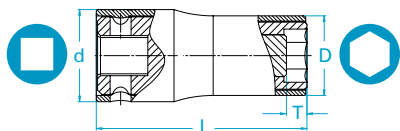

Steckschlüssel, dünnwandig, Sechskant mit Magnet, ROTACTION

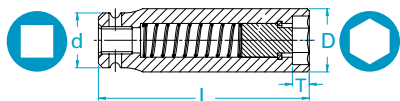

		Ø Antrieb d mm	Ø Abtrieb D mm	Länge L mm	Tiefe T mm	Gewicht g	max. Drehmoment Nm	Bestell- nummer	Steckschlüssel Abdeckung Ref.	Ersatzhülsen Bestellnummer*
Zoll	mm									
3/8	7	22	14	50	2,8	50	23	4027 1285 07	C22	4027 2985 01
3/8	8	22	15,3	50	3,5	56	32	4027 1285 08	C22	4027 2984 02
3/8	10	22	17,8	50	4,2	59	54	4027 1285 10	C22	4027 2984 11
3/8	11	22	19	50	4,9	70	67	4027 1285 11	C22	4027 2984 03
3/8	12	22	20,3	50	5,6	73	82	4027 1285 12	C22	4027 2984 04
3/8	13	25	21,5	50	6	93	99	4027 1285 13	C25	4027 2984 05
3/8	14	25	22,8	50	6,4	90	118	4027 1285 14	C25	4027 2984 06
3/8	15	25	24	50	6,8	120	138	4027 1285 15	C25	4027 2984 07
3/8	16	25	25,3	50	7	120	157	4027 1285 16	C25	4027 2984 08
3/8	17	25	26,5	50	7,5	130	157	4027 1285 17	C25	4027 2984 09
3/8	18	25	27,8	50	7,8	140	157	4027 1285 18	C25	4027 2984 10
3/8	19	25	29	50	8	154	157	4027 1285 19	C25	4027 2984 01

Steckschlüssel, Sechskant mit federndem Magnet*





		Ø Antrieb d mm	Ø Abtrieb D mm	Länge L mm	Tiefe T mm	Gewicht g	max. Drehmoment Nm	Bestell- nummer	Stift und O-Ring Ref.
Zoll	mm								
3/8	7	19	12	50	3,5	52	23	4027 1207 07	Y
3/8	7	19	12	80	3,5	73	23	4027 1240 07	Y
3/8	8	19	13,3	50	4	55	32	4027 1207 08	Y
3/8	8	19	13,3	80	4	82	32	4027 1240 08	Y
3/8	10	19	15,8	50	4,5	62	54	4027 1207 10	Y
3/8	10	19	15,8	80	4,5	105	54	4027 1240 10	Y
3/8	12	19	18,3	50	6	73	82	4027 1207 12	Y
3/8	12	19	18,3	80	6	136	82	4027 1240 12	Y
3/8	13	22	19,5	50	6,5	93	99	4027 1207 13	X
3/8	13	22	19,5	80	6,5	165	99	4027 1240 13	X
3/8	14	22	20,8	50	7	98	118	4027 1207 14	X
3/8	14	22	20,8	80	7	186	118	4027 1240 14	X
3/8	15	22	22	50	7	108	151	4027 1207 15	X
3/8	15	22	22	80	7	195	151	4027 1240 15	X
3/8	16	22	23,2	50	7,5	111	182	4027 1207 16	X
3/8	16	22	23,3	80	7,5	195	182	4027 1240 16	X
3/8	17	22	24,4	50	8	126	196	4027 1207 17	X
3/8	17	22	24,5	80	8	220	196	4027 1240 17	X
3/8	18	22	25,7	50	8,5	138	196	4027 1207 18	X
3/8	18	22	25,8	80	8,5	230	196	4027 1240 18	X
3/8	19	22	26,9	50	9	133	196	4027 1207 19	X
3/8	19	22	27	80	9	231	196	4027 1240 19	X
3/8	21	22	29,5	80	10	270	196	4027 1240 21	X
3/8	22	22	30,8	80	11	290	196	4027 1240 22	X

* Federweg ca. 20 mm

**Ersatzhülsen werden als 2er Satz mit Montageanleitung geliefert.

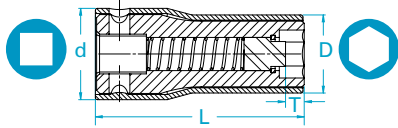
Steckschlüssel, Sechskant mit federndem Magnet*, ROTACTION





		Ø Antrieb d mm	Ø Abtrieb D mm	Länge L mm	Tiefe T mm	Gewicht g	max. Drehmoment Nm	Bestell- nummer	Steckschlüssel Abdeckung Ref.	Ersatzhülsen Bestellnummer*
Zoll	mm									
3/8	7	22	15	50	3,5	60	23	4027 1262 07	C22	4027 2981 59
3/8	7	22	15	80	3,5	80	23	4027 1265 07	C22	4027 2981 61
3/8	8	22	16,3	50	4	60	32	4027 1262 08	C22	4027 2984 71
3/8	8	22	16,3	80	4	87	32	4027 1265 08	C22	4027 2980 99
3/8	10	22	18,8	50	4,5	70	54	4027 1262 10	C22	4027 2984 70
3/8	10	22	18,8	80	4,5	109	54	4027 1265 10	C22	4027 2981 00
3/8	12	22	21,3	50	6	82	82	4027 1262 12	C22	4027 2983 74
3/8	12	22	21,3	80	6	120	82	4027 1265 12	C22	4027 2982 95
3/8	13	25	22,5	50	6,5	70	99	4027 1262 13	C25	4027 2982 96
3/8	13	25	22,5	80	6,5	172	99	4027 1265 13	C25	4027 2981 01
3/8	14	25	23,8	50	7	105	118	4027 1262 14	C25	4027 2983 75
3/8	14	25	23,8	80	7	168	118	4027 1265 14	C25	4027 2983 66
3/8	15	25	25	50	7	113	151	4027 1262 15	C25	4027 2981 60
3/8	15	25	25	80	7	187	151	4027 1265 15	C25	4027 2981 62
3/8	16	25	26,2	50	7,5	105	182	4027 1262 16	C25	4027 2983 76
3/8	16	25	26,2	80	7,5	208	182	4027 1265 16	C25	4027 2981 63
3/8	17	25	27,4	50	8	127	196	4027 1262 17	C25	4027 2983 77
3/8	17	25	27,5	80	8	229	196	4027 1265 17	C25	4027 2983 67
3/8	18	25	28,8	50	8,5	140	196	4027 1262 18	C25	4027 2983 78
3/8	18	25	28,8	80	8,5	210	196	4027 1265 18	C25	4027 2981 64
3/8	19	25	30	50	9	145	196	4027 1262 19	C25	4027 2983 79
3/8	19	25	30	80	9	233	196	4027 1265 19	C25	4027 2983 68
3/8	21	25	32,5	80	10	284	196	4027 1265 21	C25	4027 2983 69
3/8	22	25	33,8	80	11	310	196	4027 1265 22	C25	4027 2981 65

* Federweg ca. 20 mm

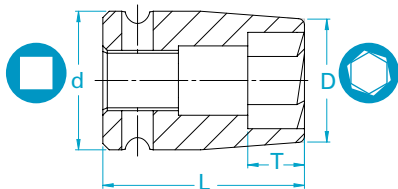
Steckschlüssel, Sechskant mit Einführschrägen





		Ø Antrieb d mm	Ø Abtrieb D mm	Länge L mm	Tiefe T mm	Gewicht g	max. Drehmoment Nm	Bestell- nummer	Ref. Typ
Zoll	mm								
3/8	10	19	15,8	32	8	43	54	4027 1218 10	Y
3/8	10	19	15,8	80	8	99	54	4027 1219 10	Y
3/8	11	19	17	32	8	44	67	4027 1218 11	Y
3/8	11	19	17	80	8	108	67	4027 1219 11	Y
3/8	12	19	18,3	32	9	47	82	4027 1218 12	Y
3/8	12	19	18,3	80	9	110	82	4027 1219 12	Y
3/8	13	22	19,5	32	9	55	99	4027 1218 13	X
3/8	13	22	19,5	80	9	142	99	4027 1219 13	X
3/8	14	22	20,8	32	11	56	118	4027 1218 14	X
3/8	14	22	20,8	80	11	144	118	4027 1219 14	X
3/8	15	22	22	32	11	58	151	4027 1218 15	X
3/8	15	22	22	80	11	150	151	4027 1219 15	X
3/8	16	22	23,3	32	11	57	182	4027 1218 16	X
3/8	16	22	23,3	80	11	159	182	4027 1219 16	X
3/8	17	22	24,5	32	12	60	196	4027 1218 17	X
3/8	17	22	24,5	80	12	170	196	4027 1219 17	X
3/8	18	22	25,8	32	13	63	196	4027 1218 18	X
3/8	18	22	25,8	80	13	201	196	4027 1219 18	X
3/8	19	22	27	32	13	68	196	4027 1218 19	X
3/8	19	22	27	80	13	203	196	4027 1219 19	X

**Ersatzhülsen werden als 2er Satz mit Montageanleitung geliefert.

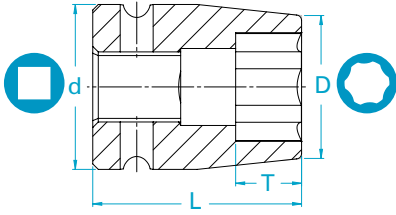
Steckschlüssel, Surface Drive



		Ø Antrieb d mm	Ø Abtrieb D mm	Länge L mm	Tiefe T mm	Gewicht g	max. Drehmoment Nm	Bestell- nummer	Stift und O-Ring Ref.
Zoll	mm								
3/8	6	19	10,8	32	5	40	17	4027 1208 06	Y
3/8	7	19	12	32	5	40	23	4027 1208 07	Y
3/8	7	19	12	80	7	70	23	4027 1210 07	Y
3/8	8	19	13,3	32	6	40	32	4027 1208 08	Y
3/8	8	19	13,3	80	8	90	32	4027 1210 08	Y
3/8	9	19	14,5	32	7	40	42	4027 1208 09	Y
3/8	9	19	14,5	80	9	90	42	4027 1210 09	Y
3/8	10	19	15,8	32	7	40	54	4027 1208 10	Y
3/8	10	19	15,8	80	10	97	54	4027 1210 10	Y
3/8	11	19	17	32	8	42	67	4027 1208 11	Y
3/8	11	19	17	80	11	110	67	4027 1210 11	Y
3/8	12	19	18,3	32	9	43	82	4027 1208 12	Y
3/8	12	19	18,3	80	12	115	82	4027 1210 12	Y
3/8	13	22	19,5	32	10	56	99	4027 1208 13	X
3/8	13	22	19,5	80	13	135	99	4027 1210 13	X
3/8	14	22	20,8	32	10	56	118	4027 1208 14	X
3/8	14	22	20,8	80	14	145	118	4027 1210 14	X
3/8	15	22	22	32	11	56	151	4027 1208 15	X
3/8	15	22	22	80	15	160	151	4027 1210 15	X
3/8	16	22	23,3	32	11	57	182	4027 1208 16	X
3/8	16	22	23,3	80	16	156	182	4027 1210 16	X
3/8	17	22	24,5	32	12	60	196	4027 1208 17	X
3/8	17	22	24,5	80	17	168	196	4027 1210 17	X
3/8	18	22	25,8	32	12	62	196	4027 1208 18	X
3/8	18	22	25,7	80	18	185	196	4027 1210 18	X
3/8	19	22	27	32	12	67	196	4027 1208 19	X
3/8	19	22	27	80	19	190	196	4027 1210 19	X
3/8	21	22	29,5	32	12	71	196	4027 1208 21	X
3/8	21	22	29,4	80	21	226	196	4027 1210 21	X
3/8	22	22	30,8	32	13	72	196	4027 1208 22	X
3/8	22	22	30,7	80	22	231	196	4027 1210 22	X

Steckschlüssel, Surface Drive, ROTACTION

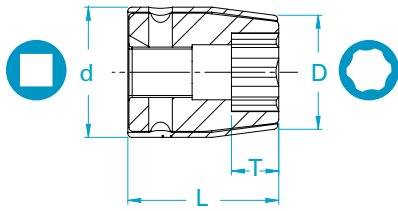



		Ø Antrieb d mm	Ø Abtrieb D mm	Länge L mm	Tiefe T mm	Gewicht g	max. Drehmoment Nm	Bestell- nummer	Steckschlüssel Abdeckung Ref.	Ersatzhülsen Bestellnummer*
Zoll	mm									
3/8	7	22	15	32	5	46	23	4027 1211 07	C22	4027 2982 27
3/8	8	22	16,3	32	6	44	32	4027 1211 08	C22	4027 2980 71
3/8	8	22	16,3	80	8	95	32	4027 1271 08	C22	4027 2981 02
3/8	10	22	18,8	32	7	44	54	4027 1211 10	C22	4027 2980 72
3/8	10	22	18,8	80	10	102	54	4027 1271 10	C22	4027 2981 03
3/8	11	22	20	32	8	46	67	4027 1211 11	C22	4027 2982 28
3/8	12	22	21,3	32	9	47	82	4027 1211 12	C22	4027 2982 29
3/8	12	22	21,3	80	12	106	82	4027 1271 12	C22	4027 2982 80
3/8	13	25	22,5	32	10	61	99	4027 1211 13	C25	4027 2980 73
3/8	13	25	22,5	80	13	142	99	4027 1271 13	C25	4027 2981 04
3/8	14	25	23,8	32	10	60	118	4027 1211 14	C25	4027 2982 30
3/8	14	25	23,8	80	14	133	118	4027 1271 14	C25	4027 2982 81
3/8	15	25	25	32	11	58	151	4027 1211 15	C25	4027 2982 31
3/8	15	25	25	80	15	143	151	4027 1271 15	C25	4027 2982 82
3/8	16	25	26,3	32	11	60	182	4027 1211 16	C25	4027 2980 74
3/8	16	25	26,2	80	16	163	182	4027 1271 16	C25	4027 2981 05
3/8	17	25	27,5	32	12	65	196	4027 1211 17	C25	4027 2980 75
3/8	17	25	27,5	80	17	161	196	4027 1271 17	C25	4027 2982 83
3/8	18	25	28,8	32	12	68	196	4027 1211 18	C25	4027 2980 76
3/8	18	25	28,8	80	18	171	196	4027 1271 18	C25	4027 2982 84
3/8	19	25	30	32	12	71	196	4027 1211 19	C25	4027 2980 77
3/8	19	25	30	80	19	181	196	4027 1271 19	C25	4027 2982 85

Vierkanttrieb
3/8"

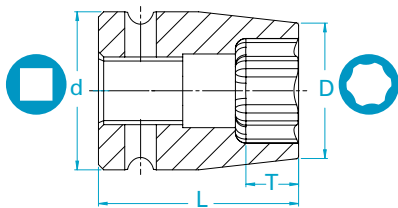
Steckschlüssel, Surface Drive, LongLife





		Ø Antrieb d mm	Ø Abtrieb D mm	Länge L mm	Tiefe T mm	Gewicht g	max. Drehmoment Nm	Bestell- nummer	Stift und O-Ring Ref.
Zoll	mm								
3/8	10	19	15,8	32	5	44	54	4027 1214 10	Y
3/8	13	22	19,5	32	7	60	99	4027 1214 13	X
3/8	16	22	23,3	32	9	58	182	4027 1214 16	X
3/8	17	22	24,5	32	9	62	196	4027 1214 17	X

*Ersatzhülsen werden als 2er Satz mit Montageanleitung geliefert.

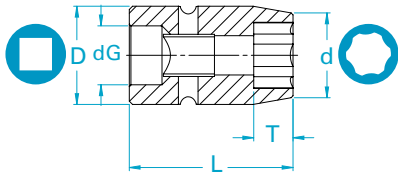

Steckschlüssel, Surface Drive, geführt

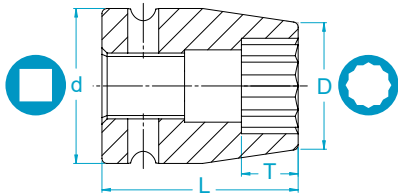

		Ø Antrieb d mm	Ø Abtrieb D mm	Ø Führung d _G mm	Länge L mm	Tiefe T mm	Gewicht g	max. Drehmoment Nm	Bestell- nummer	Stift und O-Ring Ref.
Zoll	mm									
3/8	8	19	13,3	13	50	6	59	32	4027 1212 08	Y
3/8	8	19	13,3	13	100	8	110	32	4027 1213 08	Y
3/8	10	19	15,8	13	50	7	62	54	4027 1212 10	Y
3/8	10	19	15,8	13	100	10	112	54	4027 1213 10	Y
3/8	12	19	18,3	13	50	9	64	82	4027 1212 12	Y
3/8	12	19	18,3	13	100	12	120	82	4027 1213 12	Y
3/8	13	22	19,5	13	50	10	94	99	4027 1212 13	X
3/8	13	22	19,5	13	100	13	127	99	4027 1213 13	X
3/8	14	22	20,8	13	50	10	94	118	4027 1212 14	X
3/8	14	22	20,8	13	100	14	131	118	4027 1213 14	X
3/8	16	22	23,3	13	50	11	97	182	4027 1212 16	X
3/8	16	22	23,3	13	100	16	144	182	4027 1213 16	X
3/8	17	22	24,5	13	50	12	99	196	4027 1212 17	X
3/8	17	22	24,5	13	100	17	154	196	4027 1213 17	X

Steckschlüssel, Doppelsechskant



		Ø Antrieb d mm	Ø Abtrieb D mm	Länge L mm	Tiefe T mm	Gewicht g	max. Drehmoment Nm	Bestell- nummer	Stift und O-Ring Ref.
Zoll	mm								
3/8	8	19	13,3	32	6	40	32	4027 1215 08	Y
3/8	8	19	13,3	80	8	82	32	4027 1217 08	Y
3/8	9	19	14,5	32	7	40	42	4027 1215 09	Y
3/8	9	19	14,5	80	9	88	42	4027 1217 09	Y
3/8	10	19	15,8	32	7	40	54	4027 1215 10	Y
3/8	10	19	15,8	80	10	94	54	4027 1217 10	Y
3/8	11	19	17	32	8	41	67	4027 1215 11	Y
3/8	11	19	17	80	11	110	67	4027 1217 11	Y
3/8	12	19	18,3	32	9	43	82	4027 1215 12	Y
3/8	12	19	18,3	80	12	111	82	4027 1217 12	Y
3/8	13	22	19,5	32	10	56	99	4027 1215 13	X
3/8	13	22	19,5	80	13	138	99	4027 1217 13	X
3/8	14	22	20,8	32	10	56	118	4027 1215 14	X
3/8	14	22	20,8	80	14	148	118	4027 1217 14	X
3/8	15	22	22	32	11	56	151	4027 1215 15	X
3/8	15	22	22	80	15	157	151	4027 1217 15	X
3/8	16	22	23,3	32	11	58	182	4027 1215 16	X
3/8	16	22	23,3	80	16	158	182	4027 1217 16	X
3/8	17	22	24,5	32	12	60	196	4027 1215 17	X
3/8	17	22	24,5	80	17	168	196	4027 1217 17	X
3/8	18	22	25,8	32	12	62	196	4027 1215 18	X
3/8	18	22	25,8	80	18	190	196	4027 1217 18	X
3/8	19	22	27	32	12	67	196	4027 1215 19	X
3/8	19	22	27	80	19	192	196	4027 1217 19	X
3/8	21	22	29,5	32	12	72	196	4027 1215 21	X
3/8	22	22	30,8	32	13	72	196	4027 1215 22	X
3/8	24	22	33,3	32	13	75	196	4027 1215 24	x
in	in								
3/8	1/4	19	10,8	32	5	40	20	4027 1215 96	Y
3/8	5/16	19	13,3	32	6	40	32	4027 1215 93	Y
3/8	3/8	19	15,8	32	7	40	49	4027 1215 91	Y
3/8	7/16	19	17	32	8	41	70	4027 1215 88	Y
3/8	1/2	22	19,5	32	10	56	95	4027 1215 86	X
3/8	5/8	22	23,3	32	11	57	180	4027 1215 83	X
3/8	3/4	22	27	32	12	67	196	4027 1215 81	X

Steckschlüssel, dünnwandig, Doppelsechskant

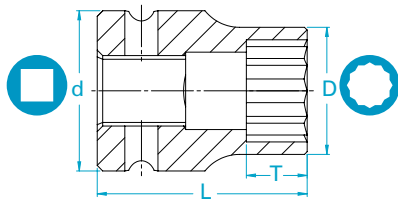



		Ø Antrieb d mm	Ø Abtrieb D mm	Länge L mm	Tiefe T mm	Gewicht g	max. Drehmoment Nm	Bestell- nummer	Stift und O-Ring Ref.
Zoll	mm								
3/8	8	18,5	12,3	32	6	31	32	4027 1216 08	Y
3/8	9	18,5	13,5	32	7	33	42	4027 1216 09	Y
3/8	10	18,5	14,8	32	7	34	54	4027 1216 10	Y
3/8	11	18,5	16	32	8	35	67	4027 1216 11	Y
3/8	12	18,5	17,3	32	9	35	82	4027 1216 12	Y
3/8	13	21,5	18,5	32	10	43	99	4027 1216 13	X
3/8	14	21,5	19,8	32	10	47	118	4027 1216 14	X
3/8	15	21,5	21	32	11	49	138	4027 1216 15	X
3/8	16	21,5	22,3	32	11	51	157	4027 1216 16	X
3/8	17	21,5	23,5	32	12	54	157	4027 1216 17	X
3/8	18	21,5	24,8	32	12	57	157	4027 1216 18	X
3/8	19	21,5	26	32	12	60	157	4027 1216 19	X
3/8	21	21,5	28,5	32	12	70	157	4027 1216 21	X
3/8	22	21,5	29,8	32	13	73	157	4027 1216 22	X
3/8	24	21,5	32,3	32	13	75	157	4027 1216 24	X
in	in								
3/8	1/4	18,5	10	32	5	28	20	4027 1216 96	Y
3/8	5/16	18,5	12,3	32	6	31	32	4027 1216 93	Y
3/8	3/8	18,5	14,8	32	7	34	49	4027 1216 91	Y
3/8	7/16	18,5	16	32	8	35	70	4027 1216 88	Y
3/8	1/2	21,5	18,5	32	10	43	95	4027 1216 86	X
3/8	9/16	21,5	19,8	32	10	49	125	4027 1216 84	X
3/8	5/8	21,5	22,3	32	11	51	157	4027 1216 83	X
3/8	3/4	21,5	26	32	12	60	157	4027 1216 81	X

Vierkanttrieb
3/8"

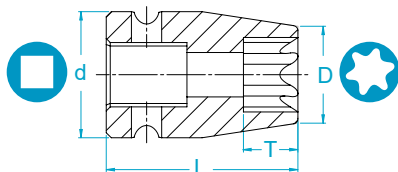
Steckschlüssel, für Torx®-Schrauben



		Ø Antrieb d mm	Ø Abtrieb D mm	Länge L mm	Tiefe T mm	Gewicht g	max. Drehmoment Nm	Bestell- nummer	Stift und O-Ring Ref.
Zoll									
3/8	E4	19	9,7	32	3,6	44	4,1	4027 1220 04	Y
3/8	E5	19	10,2	32	4,2	43	7,3	4027 1220 05	Y
3/8	E6	19	10,7	32	4,4	46	10	4027 1220 06	Y
3/8	E6	19	10,7	80	4,4	77	10	4027 1221 06	Y
3/8	E7	19	11,2	32	5,6	44	15	4027 1220 07	Y
3/8	E7	19	11,2	80	5,6	79	15	4027 1221 07	Y
3/8	E8	19	11,7	32	6	44	28	4027 1220 08	Y
3/8	E8	19	11,7	80	6	81	28	4027 1221 08	Y
3/8	E10	19	12,2	32	7,2	42	62	4027 1220 10	Y
3/8	E10	19	12,2	80	7,2	83	62	4027 1221 10	Y
3/8	E12	19	14,2	32	8,3	43	129	4027 1220 12	Y
3/8	E12	19	14,2	80	8,3	87	129	4027 1221 12	Y
3/8	E14	19	17,2	32	9,6	44	153	4027 1220 14	Y
3/8	E14	19	17,2	80	9,6	110	153	4027 1221 14	Y
3/8	E16	19	18,2	32	10,8	42	196	4027 1220 16	Y
3/8	E16	19	18,2	80	10,8	111	196	4027 1221 16	Y

Torx®, Torx Plus® sind eingetragene Warenzeichen von Acument Intellectual Properties, LLC.

Steckschlüssel, für Torx®-Schrauben, ROTACTION

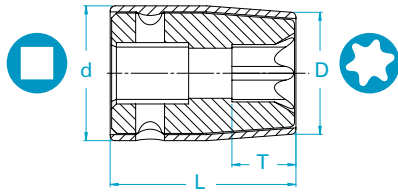

		Ø Antrieb d mm	Ø Abtrieb D mm	Länge L mm	Tiefe T mm	Gewicht g	max. Drehmoment Nm	Bestell- nummer	Steckschlüssel Abdeckung Ref.	Ersatzhülsen Bestellnummer*
Zoll										
3/8	E7	22	14,2	32	5,6	50	15	4027 1264 07	C22	4027 2982 39
3/8	E8	22	14,7	32	6	46	28	4027 1264 08	C22	4027 2980 87
3/8	E8	22	14,7	80	6	75	28	4027 1281 08	C22	4027 2982 33
3/8	E10	22	15,2	32	7,2	44	62	4027 1264 10	C22	4027 2980 88
3/8	E10	22	15,2	80	7,2	72	62	4027 1281 10	C22	4027 2982 35
3/8	E12	22	17,2	32	8,3	44	129	4027 1264 12	C22	4027 2980 89
3/8	E12	22	17,2	80	8,3	84	129	4027 1281 12	C22	4027 2982 93
3/8	E14	22	20,2	32	9,6	48	153	4027 1264 14	C22	4027 2980 90

Steckschlüssel, für Torx®-Schrauben mit Magnet

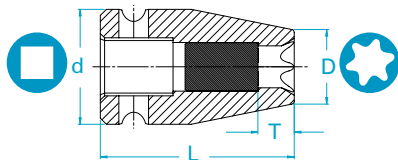

		Ø Antrieb d mm	Ø Abtrieb D mm	Länge L mm	Tiefe T mm	Gewicht g	max. Drehmoment Nm	Bestell- nummer	Stift und O-Ring Ref.
Zoll									
3/8	E7	19	11,2	32	4,5	40	15	4027 1280 07	Y
3/8	E8	19	11,7	32	5,5	44	28	4027 1280 08	Y
3/8	E10	19	12,2	32	6	42	62	4027 1280 10	Y
3/8	E12	19	14,2	32	6	50	129	4027 1280 12	Y
3/8	E14	19	17,2	32	7,5	50	153	4027 1280 14	Y

Steckschlüssel, für Torx®-Schrauben mit Magnet, ROTACTION

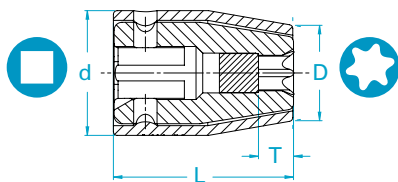

		Ø Antrieb d mm	Ø Abtrieb D mm	Länge L mm	Tiefe T mm	Gewicht g	max. Drehmoment Nm	Bestell- nummer	Steckschlüssel Abdeckung Ref.	Ersatzhülsen Bestellnummer*
Zoll										
3/8	E7	22	14,2	32	4,5	46	15	4027 1280 57	C22	4027 2983 54
3/8	E8	22	14,8	32	5,5	47	28	4027 1280 58	C22	4027 2983 55
3/8	E10	22	15,2	32	6	46	62	4027 1280 60	C22	4027 2983 56
3/8	E12	22	17,2	32	6	48	129	4027 1280 62	C22	4027 2983 57
3/8	E14	22	20,2	32	7,5	52	153	4027 1280 64	C22	4027 2983 58

*Ersatzhülsen werden als 2er Satz mit Montageanleitung geliefert.

Torx®, Torx Plus® sind eingetragene Warenzeichen von Acument Intellectual Properties, LLC.

Steckschlüssel, für TorxPlus®-Schrauben

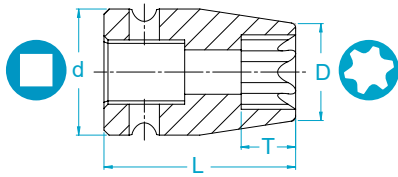

		Ø Antrieb d mm	Ø Abtrieb D mm	Länge L mm	Tiefe T mm	Gewicht g	max. Drehmoment Nm	Bestell- nummer	Stift und O-Ring Ref.
Zoll									
3/8	8EPL	19	12	32	4,2	44	35	4027 1222 08	Y
3/8	10EPL	19	13,3	32	5,2	44	79	4027 1222 10	Y

Gelenkschlüssel, Sechskant**

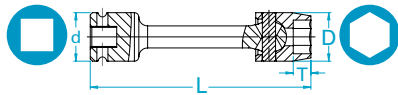

		Ø Antrieb d mm	Ø Abtrieb D mm	Länge L mm	Tiefe T mm	Gewicht g	Bestell- nummer	Stift und O-Ring Ref.
Zoll	mm							
3/8	10	19	18	45	7	58	4027 1231 10	Y
3/8	10	19	18	100	7	80	4027 1232 10	Y
3/8	10	19	18	150	7	100	4027 1233 10	Y
3/8	11	19	19	50	7	72	4027 1231 11	Y
3/8	11	19	19	100	7	105	4027 1232 11	Y
3/8	11	19	19	150	7	125	4027 1233 11	Y
3/8	12	19	20	50	8	75	4027 1231 12	Y
3/8	12	19	20	100	8	110	4027 1232 12	Y
3/8	12	19	20	150	8	130	4027 1233 12	Y
3/8	13	22	22	50	8	96	4027 1231 13	X
3/8	13	22	22	100	8	135	4027 1232 13	X
3/8	13	22	22	150	8	160	4027 1233 13	X
3/8	14	22	23	54	9	112	4027 1231 14	X
3/8	14	22	23	100	9	145	4027 1232 14	X
3/8	14	22	23	150	9	175	4027 1233 14	X
3/8	15	22	24	58	9	120	4027 1231 15	X
3/8	15	22	24	100	9	165	4027 1232 15	X
3/8	15	22	24	150	9	200	4027 1233 15	X
3/8	16	22	27	58	10	157	4027 1231 16	X
3/8	16	22	27	100	10	185	4027 1232 16	X
3/8	16	22	27	150	10	225	4027 1233 16	X
3/8	17	22	27	100	10	178	4027 1232 17	X
3/8	17	22	27	150	10	220	4027 1233 17	X
in	in							
3/8	3/8	19	18	100	7	85	4027 1232 91	Y
3/8	7/16	19	19	100	7	105	4027 1232 88	Y
3/8	1/2	22	22	100	8	140	4027 1232 86	X
3/8	9/16	22	23	100	9	140	4027 1232 84	X
3/8	5/8	22	27	100	10	185	4027 1232 83	X
3/8	11/16	22	27	100	10	175	4027 1232 82	X



Vierkanttrieb
3/8"

Torx®, Torx Plus® sind eingetragene Warenzeichen von Acument Intellectual Properties, LLC.

**Aufgrund der Drehmomentbegrenzungen für Universal-Steckschlüssel wird stattdessen die Verwendung eines Pendeladapters mit Steckschlüssel empfohlen.

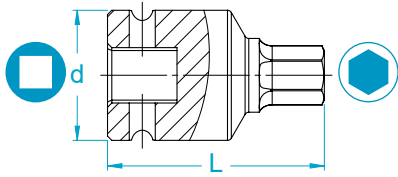

Bit Steckschlüssel, für Innensechskant-Schrauben



		Ø Antrieb d mm	Länge L mm	Gewicht g	max. Drehmoment Nm	Bestell- nummer	Stift und O-Ring Ref.
Zoll	mm						
3/8	4	19	50	35	13	4027 1223 04	Y
3/8	5	19	50	34	25	4027 1223 05	Y
3/8	6	19	50	39	43	4027 1223 06	Y
3/8	7	19	50	44	68	4027 1223 07	Y
3/8	8	19	50	60	98	4027 1223 08	Y
3/8	10	19	50	70	179	4027 1223 10	Y

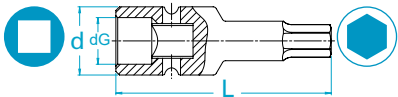

Bit Steckschlüssel, für Innensechskant-Schrauben, geführt

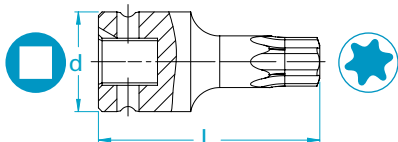

		Ø Antrieb d mm	Ø Führung d _g mm	Länge L mm	Gewicht g	max. Drehmoment Nm	Bestell- nummer	Stift und O-Ring Ref.
Zoll	mm							
3/8	6	19	13	60	52	43	4027 1289 06	Y
3/8	8	19	13	60	61	98	4027 1289 08	Y
3/8	10	19	13	60	73	179	4027 1289 10	Y

Bit Steckschlüssel, für Torx®-Schrauben



		Ø Antrieb d mm	Länge L mm	Gewicht g	max. Drehmoment Nm	Bestell- nummer	Stift und O-Ring Ref.
Zoll							
3/8	T25	19	100	53	13	4027 1227 25	Y
3/8	T30	19	50	37	26	4027 1226 30	Y
3/8	T30	19	100	57	26	4027 1227 30	Y
3/8	T30	19	150	69	26	4027 1228 30	Y
3/8	T40	19	50	40	46	4027 1226 40	Y
3/8	T40	19	100	60	46	4027 1227 40	Y
3/8	T40	19	150	80	46	4027 1228 40	Y
3/8	T45	19	50	40	72	4027 1226 45	Y
3/8	T45	19	100	61	72	4027 1227 45	Y
3/8	T45	19	150	83	72	4027 1228 45	Y
3/8	T50	22	50	57	111	4027 1226 50	X
3/8	T50	22	100	90	111	4027 1227 50	X
3/8	T50	22	150	121	111	4027 1228 50	X
3/8	T55	22	50	67	180	4027 1226 55	X
3/8	T55	22	100	111	180	4027 1227 55	X
3/8	T55	22	150	155	180	4027 1228 55	X

Torx®, Torx Plus® sind eingetragene Warenzeichen von Acument Intellectual Properties, LLC.

Bit Steckschlüssel, für Torx®-Schrauben, ROTACTION

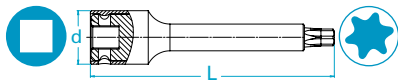

		Ø Antrieb d mm	Länge L mm	Gewicht g	max. Drehmoment Nm	Bestell- nummer	Steckschlüssel Abdeckung Ref.	Ersatzhülsen Bestellnummer*
Zoll								
3/8	T25	22	100	64	13	4027 1256 25	C22	4027 2984 76
3/8	T30	22	50	42	26	4027 1272 30	C22	4027 2980 00
3/8	T30	22	100	57	26	4027 1256 30	C22	4027 2980 05
3/8	T30	22	150	75	26	4027 1273 30	C22	4027 2980 10
3/8	T40	22	50	43	46	4027 1272 40	C22	4027 2980 01
3/8	T40	22	100	63	46	4027 1256 40	C22	4027 2980 06
3/8	T40	22	150	86	46	4027 1273 40	C22	4027 2980 11
3/8	T45	22	50	44	72	4027 1272 45	C22	4027 2980 02
3/8	T45	22	100	66	72	4027 1256 45	C22	4027 2980 07
3/8	T45	22	150	87	72	4027 1273 45	C22	4027 2980 12
3/8	T50	25	50	62	111	4027 1272 50	C25	4027 2980 03
3/8	T50	25	100	95	111	4027 1256 50	C25	4027 2980 08
3/8	T50	25	150	129	111	4027 1273 50	C25	4027 2980 13
3/8	T55	25	50	70	180	4027 1272 55	C25	4027 2980 04
3/8	T55	25	100	117	180	4027 1256 55	C25	4027 2980 09
3/8	T55	25	150	163	180	4027 1273 55	C25	4027 2980 14

Vierkanttrieb
3/8"

Bit Steckschlüssel, für Torx®-Schrauben mit Ringmagnet, ROTACTION



		Ø Antrieb d mm	Ø Abtrieb D mm	Länge L mm	Tiefe T mm	Gewicht g	max. Drehmoment Nm	Bestell- nummer	Steckschlüssel Abdeckung Ref.
Zoll									
3/8	T25	22	13,7	100	3	72	13	4027 1227 26	C22
3/8	T30	22	13,7	50	3,2	47	26	4027 1226 31	C22
3/8	T30	22	13,7	100	3,2	72	26	4027 1227 31	C22
3/8	T30	22	13,7	150	3,2	94	26	4027 1228 31	C22
3/8	T40	22	16,7	50	3,4	58	46	4027 1226 41	C22
3/8	T40	22	16,7	100	3,4	89	46	4027 1227 41	C22
3/8	T40	22	16,7	150	3,4	120	46	4027 1228 41	C22
3/8	T45	22	16,7	50	3,9	57	72	4027 1226 46	C22
3/8	T45	22	16,7	100	3,9	90	72	4027 1227 46	C22
3/8	T45	22	16,7	150	3,9	121	72	4027 1228 46	C22
3/8	T50	25	19,7	50	4,6	83	111	4027 1226 51	C25
3/8	T50	25	19,7	100	4,6	130	111	4027 1227 51	C25
3/8	T50	25	19,7	150	4,6	178	111	4027 1228 51	C25
3/8	T55	25	22,2	50	5,1	99	180	4027 1226 56	C25
3/8	T55	25	22,2	100	5,1	162	180	4027 1227 56	C25
3/8	T55	25	22,2	150	5,1	225	180	4027 1228 56	C25

*Ersatzhülsen werden als 2er Satz mit Montageanleitung geliefert.

Torx®, Torx Plus® sind eingetragene Warenzeichen von Acument Intellectual Properties, LLC.

Bit Steckschlüssel, für Torx®-Schrauben, geführt

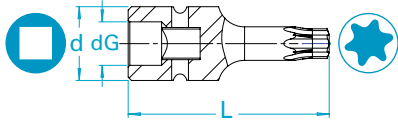

		Ø Antrieb d mm	Ø Führung d _G mm	Länge L mm	Gewicht g	max. Drehmoment Nm	Bestell- nummer	Stift und O-Ring Ref.
Zoll								
3/8	T30	19	13	60	48	26	4027 1229 30	Y
3/8	T30	19	13	110	65	26	4027 1230 30	Y
3/8	T40	19	13	60	51	46	4027 1229 40	Y
3/8	T40	19	13	110	71	46	4027 1230 40	Y
3/8	T45	19	13	60	52	72	4027 1229 45	Y
3/8	T45	19	13	110	72	72	4027 1230 45	Y
3/8	T50	22	13	60	80	111	4027 1229 50	X
3/8	T50	22	13	110	110	111	4027 1230 50	X
3/8	T55	22	13	60	86	180	4027 1229 55	X
3/8	T55	22	13	110	174	180	4027 1230 55	X

Bit Steckschlüssel, für TorxPlus®-Schrauben mit Ringmagnet, ROTACTION



		Ø Antrieb d mm	Ø Abtrieb D mm	Länge L mm	Tiefe T mm	Gewicht g	max. Drehmoment Nm	Bestell- nummer	Steckschlüssel Abdeckung Ref.
Zoll									
3/8	40IP	22	16,7	150	3,4	120	57	4027 1228 42	C22
3/8	45IP	22	16,7	150	3,9	120	96	4027 1228 47	C22

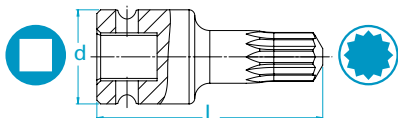

Bit Steckschlüssel, für XZN-Schrauben



		Ø Antrieb d mm	Länge L mm	Gewicht g	max. Drehmoment Nm	Bestell- nummer	Stift und O-Ring Ref.
Zoll							
3/8	05	19	50	37	13	4027 1224 05	Y
3/8	05	19	100	59	13	4027 1225 05	Y
3/8	06	19	50	39	25	4027 1224 06	Y
3/8	06	19	100	61	25	4027 1225 06	Y
3/8	08	19	50	40	43	4027 1224 08	Y
3/8	08	19	100	62	43	4027 1225 08	Y
3/8	10	19	50	65	98	4027 1224 10	Y
3/8	10	19	100	99	98	4027 1225 10	Y
3/8	12	19	50	69	154	4027 1224 12	Y
3/8	12	19	100	103	154	4027 1225 12	Y

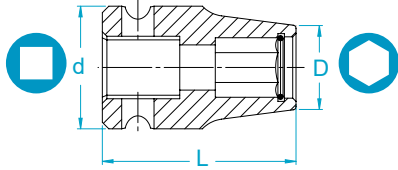

Bithalter, Vierkanttrieb, für Bits mit Sechskant Form C

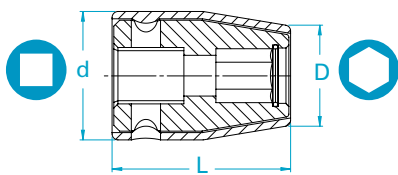

		Ø Antrieb d mm	Ø Abtrieb D mm	Länge L mm	Gewicht g	Bestell- nummer	Stift und O-Ring Ref.
Zoll	Zoll						
3/8	1/4	19	11	30	33	4027 1235 00	Y
3/8	5/16	19	14	30	34	4027 1235 01	Y

Bithalter, Vierkanttrieb, für Bits mit Sechskant Form C, ROTACTION





		Ø Antrieb d mm	Ø Abtrieb D mm	Länge L mm	Gewicht g	Bestell- nummer	Ref. Typ	Ersatzhülsen Bestellnummer*
Zoll	Zoll							
3/8	1/4	22	14	30	35	4027 1235 70	C22	4027 2980 84
3/8	5/16	22	17	30	38	4027 1235 71	C22	4027 2980 85

Vierkanttrieb
3/8"

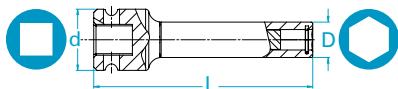

Bithalter, Vierkanttrieb, für Bits mit Sechskant Form C mit Magnet

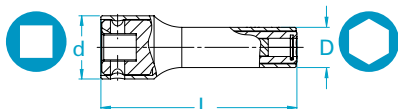

		Ø Antrieb d mm	Ø Abtrieb D mm	Länge L mm	Gewicht g	Bestell- nummer	Stift und O-Ring Ref.
Zoll	Zoll						
3/8	1/4	19	11	68	60	4027 1235 90	Y
3/8	5/16	19	14	68	80	4027 1235 92	Y

Bithalter, Vierkanttrieb, für Bits mit Sechskant Form C mit Magnet, ROTACTION



		Ø Antrieb d mm	Ø Abtrieb D mm	Länge L mm	Gewicht g	Bestell- nummer	Steckschlüssel Abdeckung Ref.	Ersatzhülsen Bestellnummer*
Zoll	Zoll							
3/8	1/4	22	14	68	70	4027 1235 80	C22	4027 2984 94
3/8	5/16	22	17	68	90	4027 1235 82	C22	4027 2984 95

*Ersatzhülsen werden als 2er Satz mit Montageanleitung geliefert.

Bithalter, Vierkantantrieb, für 11 mm Sechskant-Bits

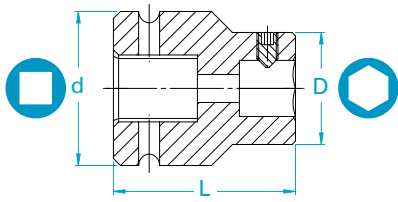

		Ø Antrieb d mm	Ø Abtrieb D mm	Länge L mm	Gewicht g	Bestell- nummer	Stift und O-Ring Ref.
Zoll	mm						
3/8	11	22	22	32	70	4027 1235 10	X

Bithalter, Vierkantantrieb, für 11 mm Sechskant-Bits, ROTACTION

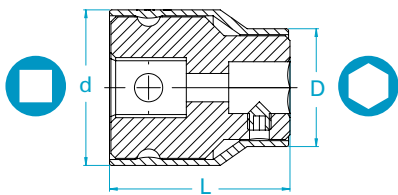

		Ø Antrieb d mm	Ø Abtrieb D mm	Länge L mm	Gewicht g	Bestell- nummer	Steckschlüssel Abdeckung Ref.	Ersatzhülsen Bestellnummer*
Zoll	mm							
3/8	11	25	25	32	?	4027 1235 15	C25	4027 2984 87

Bithalter, Vierkantantrieb, für 11 mm Sechskant-Bits, geführt

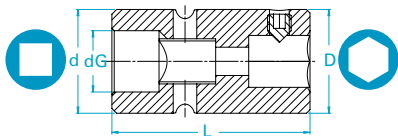



		Ø Antrieb d mm	Ø Abtrieb D mm	Ø Führung d _g mm	Länge L mm	Gewicht g	Bestell- nummer	Stift und O-Ring Ref.
Zoll	mm							
3/8	11	22	22	13	42	90	4027 1290 10	X

*Ersatzhülsen werden als 2er Satz mit Montageanleitung geliefert.

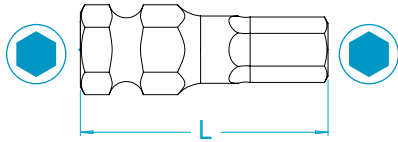
Bits, mit 11 mm Sechskantantrieb, für Innensechskant-Schrauben



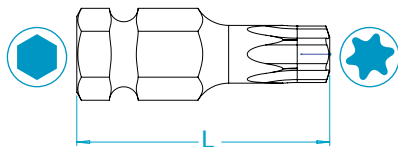

		Länge L mm	Gewicht g	max. Drehmoment Nm	Bestell- nummer
mm	mm				
11	4	35	16	13	4027 1250 04
11	5	35	16	25	4027 1250 05
11	6	35	18	43	4027 1250 06
11	7	35	20	68	4027 1250 07
11	8	35	22	98	4027 1250 08
11	10	35	26	179	4027 1250 10
11	12	35	31	229	4027 1250 12
11	14	35	36	229	4027 1250 14
11	17	35	50	229	4027 1250 17
11	19	35	56	229	4027 1250 19

Bits, mit 11 mm Sechskantantrieb, für Torx®-Schrauben





Vierkanttrieb
3/8"

		Länge L mm	Gewicht g	max. Drehmoment Nm	Bestell- nummer
mm					
11	T30	35	18	26	4027 1252 30
11	T40	35	20	46	4027 1252 40
11	T45	35	22	72	4027 1252 45
11	T50	35	26	111	4027 1252 50
11	T55	35	31	180	4027 1252 55
11	T60	35	38	312	4027 1252 60

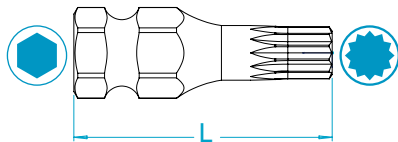

Bits, mit 11 mm Sechskantantrieb, für XZN-Schrauben



		Länge L mm	Gewicht g	max. Drehmoment Nm	Bestell- nummer
mm					
11	04	35	20	5,3	4027 1251 04
11	05	35	20	13	4027 1251 05
11	06	35	22	25	4027 1251 06
11	08	35	26	43	4027 1251 08
11	10	35	31	98	4027 1251 10
11	12	35	38	154	4027 1251 12

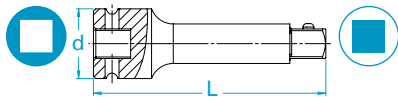

Verlängerung, Außenvierkant mit Stiftarretierung



		Ø Antrieb d mm	Länge L mm	Gewicht g	Bestell- nummer	Stift und O-Ring Ref.
Zoll	Zoll					
3/8	3/8	22	50	68	4027 1234 00	X
3/8	3/8	22	75	95	4027 1234 01	X
3/8	3/8	22	100	118	4027 1234 02	X
3/8	3/8	22	125	141	4027 1234 03	X
3/8	3/8	22	150	164	4027 1234 04	X
3/8	3/8	22	200	210	4027 1234 06	X
3/8	3/8	22	250	256	4027 1234 07	X
3/8	3/8	22	300	304	4027 1234 09	X

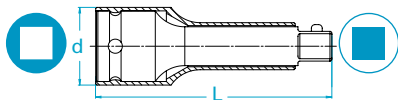

Verlängerung, Außenvierkant mit Stiftarretierung, ROTACTION

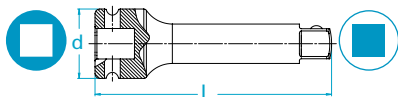

		Ø Antrieb d mm	Länge L mm	Gewicht g	Bestell- nummer	Steckschlüssel Abdeckung Ref.	Ersatzhülsen Bestellnummer*
Zoll	Zoll						
3/8	3/8	25	50	71	4027 1234 20	C25	4027 2980 30
3/8	3/8	25	75	98	4027 1234 21	C25	4027 2980 31
3/8	3/8	25	100	122	4027 1234 22	C25	4027 2980 32
3/8	3/8	25	125	145	4027 1234 23	C25	4027 2980 33
3/8	3/8	25	150	169	4027 1234 24	C25	4027 2980 34
3/8	3/8	25	200	217	4027 1234 26	C25	4027 2980 35
3/8	3/8	25	250	264	4027 1234 27	C25	4027 2980 36
3/8	3/8	25	300	312	4027 1234 29	C25	4027 2983 49

Verlängerung, Außenvierkant mit Kugelarretierung**



		Ø Antrieb d mm	Länge L mm	Gewicht g	Bestell- nummer	Stift und O-Ring Ref.
Zoll	Zoll					
3/8	3/8	22	50	68	4027 1234 40	X
3/8	3/8	22	75	95	4027 1234 41	X
3/8	3/8	22	100	118	4027 1234 42	X
3/8	3/8	22	125	141	4027 1234 43	X
3/8	3/8	22	150	164	4027 1234 44	X
3/8	3/8	22	200	210	4027 1234 46	X
3/8	3/8	22	250	256	4027 1234 47	X
3/8	3/8	22	300	304	4027 1234 49	X

*Ersatzhülsen werden als 2er Satz mit Montageanleitung geliefert.

**Das an einem Vierkantantrieb mit Kugelarretierung angebrachte Gewicht darf 0,5 kg nicht überschreiten.

Verlängerung, Außenvierkant mit Kugelarretierung, ROTACTION

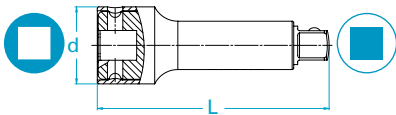

		Ø Antrieb d mm	Länge L mm	Gewicht g	Bestell- nummer	Steckschlüssel Abdeckung Ref.	Ersatzhülsen Bestellnummer*
Zoll	Zoll						
3/8	3/8	25	50	71	4027 1234 30	C25	4027 2984 13
3/8	3/8	25	75	98	4027 1234 31	C25	4027 2984 14
3/8	3/8	25	100	122	4027 1234 32	C25	4027 2984 15
3/8	3/8	25	125	145	4027 1234 33	C25	4027 2984 16
3/8	3/8	25	150	169	4027 1234 34	C25	4027 2984 17
3/8	3/8	25	200	217	4027 1234 36	C25	4027 2984 18
3/8	3/8	25	250	264	4027 1234 37	C25	4027 2984 19
3/8	3/8	25	300	312	4027 1234 39	C25	4027 2984 20

Verlängerung, Außenvierkant mit Durchgangsbohrung

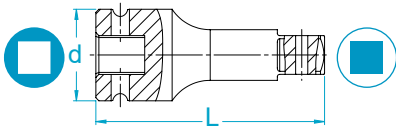

Vierkanttrieb
3/8"

		Ø Antrieb d mm	Länge L mm	Gewicht g	Bestell- nummer	Stift und O-Ring Ref.
Zoll	Zoll					
3/8	3/8	22	75	95	4027 1234 11	X
3/8	3/8	22	100	118	4027 1234 12	X
3/8	3/8	22	125	141	4027 1234 13	X
3/8	3/8	22	150	164	4027 1234 14	X
3/8	3/8	22	200	210	4027 1234 16	X
3/8	3/8	22	250	256	4027 1234 17	X

Verlängerung, Außenvierkant mit Durchgangsbohrung, geführt



		Ø Antrieb d mm	Ø Führung d _g mm	Länge L mm	Gewicht g	Bestell- nummer	Stift und O-Ring Ref.
Zoll	Zoll						
3/8	3/8	20	13	75	95	4023 3600 02	X
3/8	3/8	20	13	100	121	4023 3600 01	X
3/8	3/8	20	13	150	170	4023 3601 01	X
3/8	3/8	20	13	200	219	4023 3611 01	X
3/8	3/8	20	13	250	274	4023 3612 01	X
3/8	3/8	20	13	300	326	4023 3613 01	X

*Ersatzhülsen werden als 2er Satz mit Montageanleitung geliefert.

**Das an einem Vierkanttrieb mit Kugelarretierung angebrachte Gewicht darf 0,5 kg nicht überschreiten.

Schnellwechselfutter, für Vierkantantriebe

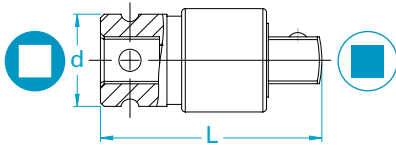

		Ø Antrieb d mm	Länge L mm	Gewicht g	Bestell- nummer	Stift und O-Ring Ref.
Zoll	Zoll	19	46	62	4027 1236 10	Y
3/8	3/8					

Schnellwechselfutter, für Vierkantantriebe, ROTACTION

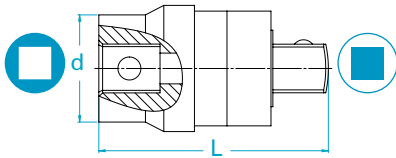

		Ø Antrieb d mm	Länge L mm	Gewicht g	Bestell- nummer	Steckschlüssel Abdeckung Ref.
Zoll	Zoll	22	45	70	4027 1236 30	C22
3/8	3/8					

Gelenk Adapter, Außenvierkant mit Stiftarretierung

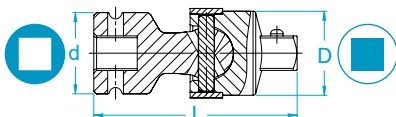

		Ø Antrieb d mm	Ø Abtrieb D mm	Länge L mm	Gewicht g	Bestell- nummer	Stift und O-Ring Ref.
Zoll	Zoll	22	24	56	110	4027 1235 40	X
3/8	3/8						

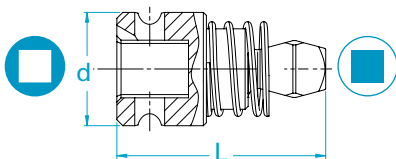

Wobble Adapter mit Feder



		Ø Antrieb d mm	Länge L mm	Gewicht g	max. Drehmoment Nm	Bestell- nummer	Stift und O-Ring Ref.
Zoll	Zoll	19	35	29	64	4027 1235 50	Y
3/8	3/8						

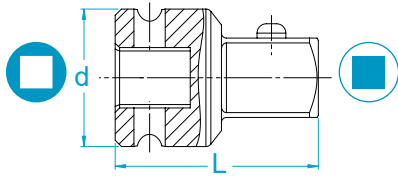

Adapter, Außenvierkant mit Stiftarretierung

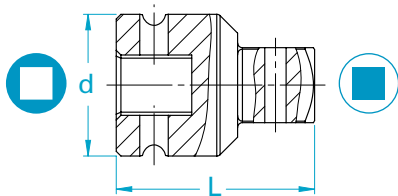

		Ø Antrieb d mm	Länge L mm	Gewicht g	Bestell- nummer	Stift und O-Ring Ref.
Zoll	Zoll					
3/8	1/4	19	27	25	4027 1235 30	Y
3/8	1/2	22	32,5	53	4027 1235 31	X

Adapter, Außenvierkant mit Durchgangsbohrung





		Ø Antrieb d mm	Länge L mm	Gewicht g	Bestell- nummer	Stift und O-Ring Ref.
Zoll	Zoll					
3/8	1/4	19	27	25	4027 1235 20	Y
3/8	1/2	22	32,5	53	4027 1235 21	X

Vierkanttrieb
3/8"

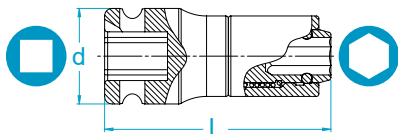

Schnellwechselfutter, Vierkantantrieb, für Bits mit Sechskant Form C



		Ø Antrieb d mm	Länge L mm	Gewicht g	Bestell- nummer	Stift und O-Ring Ref.
Zoll	Zoll					
3/8	1/4	19	45	60	4027 1236 00	Y
3/8	5/16	22	39,5	98	4027 1236 02	X

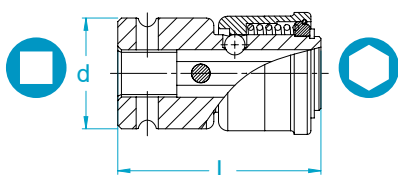

Schnellwechselfutter, Vierkantantrieb, für Bits mit Sechskant Form E



		Ø Antrieb d mm	Länge L mm	Gewicht g	Bestell- nummer	Stift und O-Ring Ref.
Zoll	Zoll					
3/8	1/4	22	46	53	4027 1236 01	X
3/8	7/16	22	45	141	4027 1236 03	X

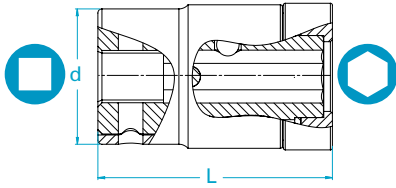

Schnellwechselfutter, Vierkantantrieb, für Bits mit Sechskant Form E, ROTACTION

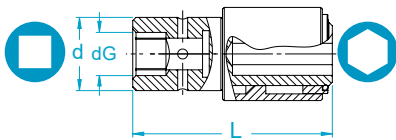

		Ø Antrieb d mm	Länge L mm	Gewicht g	Bestell- nummer	Steckschlüssel Abdeckung Ref.
Zoll	Zoll					
3/8	1/4	22	46	75	4027 1236 21	C22
3/8	7/16	25	45	162	4027 1236 23	C25

Schnellwechselfutter, Vierkantantrieb, für Bits mit Sechskant Form E, geführt



		Ø Antrieb d mm	Ø Führung d _G mm	Länge L mm	Gewicht g	Bestell- nummer	Stift und O-Ring Ref.
Zoll	Zoll						
3/8	1/4	20	13	52	77	4026 4501 00	Y
3/8	7/16	22	13	60	156	4026 4502 00	X

Vierkantantrieb 1/2"





Vierkantantrieb 1/2" 81

Steckschlüssel, Sechskant.....	82
Steckschlüssel, Sechskant, ROTACTION.....	83
Steckschlüssel, dünnwandig, Sechskant.....	84
Steckschlüssel, dünnwandig, Sechskant, ROTACTION.....	85
Steckschlüssel, Sechskant, geführt.....	85
Steckschlüssel, Sechskant mit Magnet.....	86
Steckschlüssel, Sechskant mit Magnet, ROTACTION.....	86
Steckschlüssel, Sechskant mit federndem Magnet.....	87
Steckschlüssel, Sechskant mit federndem Magnet, ROTACTION.....	88
Steckschlüssel, Sechskant mit Einführschrägen.....	88
Steckschlüssel, Surface Drive.....	89
Steckschlüssel, Surface Drive, ROTACTION.....	90
Steckschlüssel, Surface Drive, LongLife.....	90
Steckschlüssel, Surface Drive, geführt.....	91
Steckschlüssel, Doppelsechskant.....	91
Steckschlüssel, dünnwandig, Doppelsechskant.....	92
Steckschlüssel, für Torx®-Schrauben.....	92
Steckschlüssel, für Torx®-Schrauben, ROTACTION.....	93
Steckschlüssel, für Torx®-Schrauben mit Magnet.....	93
Steckschlüssel, für Torx®-Schrauben mit Magnet, ROTACTION.....	93
Steckschlüssel, für TorxPlus®-Schrauben.....	94
Gelenkschlüssel, Sechskant.....	94
Bit Steckschlüssel, für Innensechskant-Schrauben.....	95
Bit Steckschlüssel, für Innensechskant-Schrauben, geführt.....	95
Bit Steckschlüssel, für Torx®-Schrauben.....	95
Bit Steckschlüssel, für Torx®-Schrauben, ROTACTION.....	96
Bit Steckschlüssel, für Torx®-Schrauben mit Ringmagnet, ROTACTION.....	96
Bit Steckschlüssel, für Torx®-Schrauben, geführt.....	96
Bit Steckschlüssel, für XZN-Schrauben.....	97
Bithalter, Vierkantantrieb, für Bits mit Sechskant Form C.....	97
Bithalter, Vierkantantrieb, für Bits mit Sechskant Form C, ROTACTION.....	98

Bithalter, Vierkantantrieb, für Bits mit Sechskant Form C mit Magnet.....	98
Bithalter, Vierkantantrieb, für Bits mit Sechskant Form C mit Magnet, ROTACTION.....	98
Bithalter, Vierkantantrieb, für 11 mm Sechskant-Bits.....	98
Bithalter, Vierkantantrieb, für 11 mm Sechskant-Bits, ROTACTION.....	99
Bithalter, Vierkantantrieb, für 11 mm Sechskant-Bits, geführt.....	99
Bits, mit 11 mm Sechskantantrieb, für Innensechskant-Schrauben.....	99
Bits, mit 11 mm Sechskantantrieb, für Torx®-Schrauben.....	100
Bits, mit 11 mm Sechskantantrieb, für XZN-Schrauben.....	100
Verlängerung, Außenvierkant mit Stiftarretierung.....	100
Verlängerung, Außenvierkant mit Stiftarretierung, ROTACTION.....	101
Verlängerung, Außenvierkant mit Kugelarretierung.....	101
Verlängerung, Außenvierkant mit Kugelarretierung, ROTACTION.....	101
Verlängerung, Außenvierkant mit Durchgangsbohrung.....	102
Verlängerung, Außenvierkant mit Durchgangsbohrung, geführt.....	102
Schnellwechselfutter, für Vierkantantriebe.....	102
Schnellwechselfutter, für Vierkantantriebe, ROTACTION.....	103
Gelenk Adapter, Außenvierkant mit Stiftarretierung.....	103
Wobble Adapter mit Feder.....	103
Adapter, Außenvierkant mit Stiftarretierung.....	103
Adapter, Außenvierkant mit Durchgangsbohrung.....	104
Schnellwechselfutter, Vierkantantrieb, für Bits mit Sechskant Form C.....	104
Schnellwechselfutter, Vierkantantrieb, für Bits mit Sechskant Form E.....	104
Schnellwechselfutter, Vierkantantrieb, für Bits mit Sechskant Form E, ROTACTION.....	104
Schnellwechselfutter, Vierkantantrieb, für Bits mit Sechskant Form E, geführt.....	105

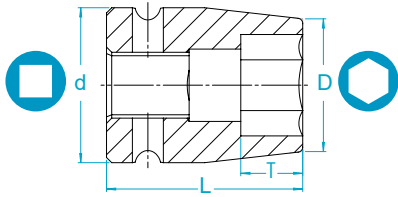

Steckschlüssel, Sechskant

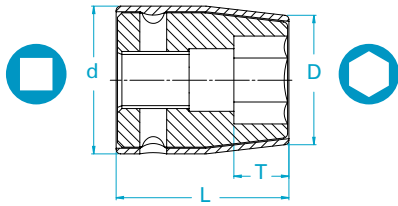

		Ø Antrieb d mm	Ø Abtrieb D mm	Länge L mm	Tiefe T mm	Gewicht g	max. Drehmoment Nm	Bestell- nummer	Stift und O-Ring Ref.
Zoll	mm								
1/2	8	25	14,5	38	6	75	32	4027 1300 08	W
1/2	8	25	14,5	80	8	137	32	4027 1303 08	W
1/2	10	25	17	38	7	86	103	4027 1300 10	W
1/2	10	25	17	80	10	140	103	4027 1303 10	W
1/2	11	25	18,2	38	8	86	125	4027 1300 11	W
1/2	11	25	18,2	80	11	156	125	4027 1303 11	W
1/2	12	25	19,5	38	9	85	148	4027 1300 12	W
1/2	12	25	19,5	80	12	162	148	4027 1303 12	W
1/2	13	25	20,7	38	10	86	174	4027 1300 13	W
1/2	13	25	20,7	80	13	162	174	4027 1303 13	W
1/2	14	25	22	38	10	87	201	4027 1300 14	W
1/2	14	25	22	80	14	174	201	4027 1303 14	W
1/2	15	30	23,2	38	11	132	280	4027 1300 15	V
1/2	15	30	23,2	80	15	220	280	4027 1303 15	V
1/2	16	30	24,5	38	11	132	350	4027 1300 16	V
1/2	16	30	24,5	80	16	232	350	4027 1303 16	V
1/2	17	30	25,7	38	12	130	400	4027 1300 17	V
1/2	17	30	25,7	80	17	232	400	4027 1303 17	V
1/2	18	30	27	38	13	130	455	4027 1300 18	V
1/2	18	30	27	80	18	232	455	4027 1303 18	V
1/2	19	30	28,2	38	13	125	455	4027 1300 19	V
1/2	19	30	28,2	80	19	259	455	4027 1303 19	V
1/2	21	30	30,7	38	14	128	455	4027 1300 21	V
1/2	21	30	30,7	80	21	265	455	4027 1303 21	V
1/2	22	30	32	38	14	129	455	4027 1300 22	V
1/2	22	30	32	85	22	290	455	4027 1303 22	V
1/2	23	30	33,2	38	14	130	455	4027 1300 23	V
1/2	24	30	34,5	38	14	135	455	4027 1300 24	V
1/2	24	30	34,5	85	24	330	455	4027 1303 24	V
1/2	27	30	38,2	40	16	160	455	4027 1300 27	V
1/2	27	30	38,2	85	27	383	455	4027 1303 27	V
1/2	30	30	42	42	17	190	455	4027 1300 30	V
1/2	30	30	42	85	30	457	455	4027 1303 30	V
1/2	32	30	44,5	42	18	218	455	4027 1300 32	V
1/2	32	30	44,5	85	32	542	455	4027 1303 32	V
in	in								
1/2	3/8	25	17	38	7	85	90	4027 1300 91	W
1/2	7/16	25	18,2	38	8	85	128	4027 1300 88	W
1/2	7/16	25	18,2	80	11	156	128	4027 1303 88	W
1/2	1/2	25	20,7	38	10	85	167	4027 1300 86	W
1/2	1/2	25	20,7	80	13	160	167	4027 1303 86	W
1/2	9/16	25	22	38	10	85	226	4027 1300 84	W
1/2	9/16	25	22	80	14	174	226	4027 1303 84	W
1/2	5/8	30	24,5	38	11	130	343	4027 1300 83	V
1/2	5/8	30	24,5	80	16	232	343	4027 1303 83	V
1/2	11/16	30	25,7	38	12	130	428	4027 1300 82	V
1/2	11/16	30	25,7	80	17	232	428	4027 1303 82	V
1/2	3/4	30	28,2	38	13	125	455	4027 1300 81	V
1/2	3/4	30	28,2	80	19	259	455	4027 1303 81	V
1/2	13/16	30	30,7	38	14	128	455	4027 1300 79	V
1/2	13/16	30	30,7	80	21	265	455	4027 1303 79	V
1/2	7/8	30	32	38	14	132	455	4027 1300 78	V
1/2	7/8	30	32	85	22	290	455	4027 1303 78	V
1/2	15/16	30	34,5	38	14	135	455	4027 1300 77	V
1/2	15/16	30	34,5	85	24	329	455	4027 1303 77	V
1/2	1	30	35,7	38	14	135	455	4027 1300 76	V
1/2	1	30	35,7	85	25	345	455	4027 1303 76	V
1/2	1,1/16	30	38,2	40	16	160	455	4027 1300 99	V
1/2	1,1/16	30	38,2	85	27	385	455	4027 1303 99	V
1/2	1,1/8	30	40,7	42	17	190	455	4027 1300 98	V
1/2	1,1/8	30	40,7	85	29	416	455	4027 1303 98	V
1/2	1,1/4	30	44,5	42	18	216	455	4027 1300 96	V
1/2	1,1/4	30	44,5	85	32	542	455	4027 1303 96	V

Steckschlüssel, Sechskant, ROTACTION





		Ø Antrieb d mm	Ø Abtrieb D mm	Länge L mm	Tiefe T mm	Gewicht g	max. Drehmoment Nm	Bestell- nummer	Steckschlüssel Abdeckung Ref.	Ersatzhülsen Bestellnummer*
Zoll	mm									
1/2	8	28	17,5	38	6	90	32	4027 1363 08	C28	4027 2981 92
1/2	8	28	17,5	80	8	122	32	4027 1344 08	C28	4027 2982 72
1/2	10	28	20	38	7	89	103	4027 1363 10	C28	4027 2981 06
1/2	10	28	20	80	10	147	103	4027 1344 10	C28	4027 2981 38
1/2	11	28	21,2	38	8	90	125	4027 1363 11	C28	4027 2981 93
1/2	11	28	21,2	80	11	152	125	4027 1344 11	C28	4027 2982 73
1/2	12	28	22,5	38	9	90	148	4027 1363 12	C28	4027 2981 94
1/2	12	28	22,5	80	12	158	148	4027 1344 12	C28	4027 2982 74
1/2	13	28	23,7	38	10	89	174	4027 1363 13	C28	4027 2981 07
1/2	13	28	23,7	80	13	169	174	4027 1344 13	C28	4027 2985 00
1/2	14	28	25	38	10	90	201	4027 1363 14	C28	4027 2981 95
1/2	14	28	25	80	14	166	201	4027 1344 14	C28	4027 2982 75
1/2	15	33	26,2	38	11	140	280	4027 1363 15	C33	4027 2981 69
1/2	15	33	26,2	80	15	211	280	4027 1344 15	C33	4027 2982 76
1/2	16	33	27,5	38	11	134	350	4027 1363 16	C33	4027 2981 08
1/2	16	33	27,5	80	16	240	350	4027 1344 16	C33	4027 2981 40
1/2	17	33	28,7	38	12	134	400	4027 1363 17	C33	4027 2981 09
1/2	17	33	28,7	80	17	241	400	4027 1344 17	C33	4027 2981 41
1/2	18	33	30	38	13	134	455	4027 1363 18	C33	4027 2981 10
1/2	18	33	30	80	18	241	455	4027 1344 18	C33	4027 2981 42
1/2	19	33	31,2	38	13	129	455	4027 1363 19	C33	4027 2981 11
1/2	19	33	31,2	80	19	268	455	4027 1344 19	C33	4027 2981 43
1/2	21	33	33,7	38	14	133	455	4027 1363 21	C33	4027 2981 12
1/2	21	33	33,7	80	21	274	455	4027 1344 21	C33	4027 2981 44
1/2	22	33	35	38	14	140	455	4027 1363 22	C33	4027 2981 97
1/2	22	33	35	85	22	303	455	4027 1344 22	C33	4027 2982 77
1/2	24	33	37,5	38	14	140	455	4027 1363 24	C33	4027 2981 13
1/2	24	33	37,5	85	24	335	455	4027 1344 24	C33	4027 2982 78
1/2	27	33	41,2	40	16	170	455	4027 1363 27	C33	4027 2981 98
1/2	27	33	41,2	85	27	379	455	4027 1344 27	C33	4027 2982 79
1/2	30	33	45	42	17	210	455	4027 1363 30	C33	4027 2981 99

*Ersatzhülsen werden als 2er Satz mit Montageanleitung geliefert.

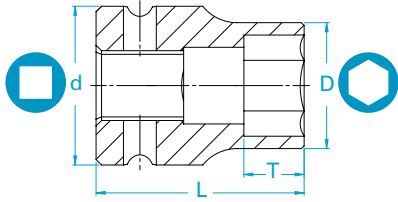

Steckschlüssel, dünnwandig, Sechskant



		Ø Antrieb d mm	Ø Abtrieb D mm	Länge L mm	Tiefe T mm	Gewicht g	max. Drehmoment Nm	Bestell- nummer	Stift und O-Ring Ref.
Zoll	mm								
1/2	8	24	13	38	6	57	32	4027 1301 08	W
1/2	8	24	13	60	8	72	32	4027 1302 08	W
1/2	10	24	15,5	38	7	60	103	4027 1301 10	W
1/2	10	24	15,5	60	10	77	103	4027 1302 10	W
1/2	10	24	15,5	80	10	100	103	4027 1304 10	W
1/2	11	24	16,7	38	8	62	125	4027 1301 11	W
1/2	11	24	16,7	60	11	82	125	4027 1302 11	W
1/2	11	24	16,7	80	11	104	125	4027 1304 11	W
1/2	12	24	18	38	9	62	148	4027 1301 12	W
1/2	12	24	18	60	12	88	148	4027 1302 12	W
1/2	12	24	18	80	12	111	148	4027 1304 12	W
1/2	13	24	19,2	38	10	65	174	4027 1301 13	W
1/2	13	24	19,2	60	13	92	174	4027 1302 13	W
1/2	13	24	19,2	80	13	122	174	4027 1304 13	W
1/2	14	24	20,5	38	10	67	201	4027 1301 14	W
1/2	14	24	20,5	60	14	97	201	4027 1302 14	W
1/2	14	24	20,5	80	14	128	201	4027 1304 14	W
1/2	15	29	21,7	38	11	101	231	4027 1301 15	V
1/2	15	29	21,7	60	15	125	231	4027 1302 15	V
1/2	15	29	21,7	80	15	170	231	4027 1304 15	V
1/2	16	29	23	38	11	102	264	4027 1301 16	V
1/2	16	29	23	60	16	135	264	4027 1302 16	V
1/2	16	29	23	80	16	173	264	4027 1304 16	V
1/2	17	29	24,2	38	12	105	298	4027 1301 17	V
1/2	17	29	24,2	60	17	142	298	4027 1302 17	V
1/2	17	29	24,2	80	17	182	298	4027 1304 17	V
1/2	18	29	25,5	38	13	105	334	4027 1301 18	V
1/2	18	29	25,5	60	18	147	334	4027 1302 18	V
1/2	18	29	25,5	80	18	192	334	4027 1304 18	V
1/2	19	29	26,7	38	13	107	372	4027 1301 19	V
1/2	19	29	26,7	60	19	151	372	4027 1302 19	V
1/2	19	29	26,7	80	19	196	372	4027 1304 19	V
1/2	21	29	29,2	38	14	109	398	4027 1301 21	V
1/2	21	29	29,2	60	21	170	398	4027 1302 21	V
1/2	21	29	29,2	80	21	218	398	4027 1304 21	V
1/2	22	29	30,5	38	14	114	398	4027 1301 22	V
1/2	22	29	30,5	65	22	187	398	4027 1302 22	V
1/2	22	29	30,5	85	22	244	398	4027 1304 22	V
1/2	24	29	33	38	14	120	398	4027 1301 24	V
1/2	24	29	33	65	24	202	398	4027 1302 24	V
1/2	24	29	33	85	24	262	398	4027 1304 24	V
1/2	27	29	36,7	40	16	145	398	4027 1301 27	V
1/2	27	29	36,7	65	27	231	398	4027 1302 27	V
1/2	27	29	36,7	85	27	314	398	4027 1304 27	V
1/2	30	29	40,5	42	17	178	398	4027 1301 30	V
1/2	30	29	40,5	65	30	265	398	4027 1302 30	V
1/2	30	29	40,5	85	30	360	398	4027 1304 30	V
1/2	32	29	43	42	18	188	398	4027 1301 32	V
1/2	32	29	43	65	32	288	398	4027 1302 32	V
1/2	32	29	43	85	32	380	398	4027 1304 32	V
in	in								
1/2	7/16	24	16,7	38	8	62	128	4027 1301 88	W
1/2	7/16	24	16,7	80	11	104	128	4027 1304 88	W
1/2	1/2	24	19,2	38	10	65	167	4027 1301 86	W
1/2	1/2	24	19,2	80	13	120	167	4027 1304 86	W
1/2	9/16	24	20,5	38	10	67	211	4027 1301 84	W
1/2	9/16	24	20,5	80	14	127	211	4027 1304 84	W
1/2	5/8	29	23	38	11	102	262	4027 1301 83	V
1/2	5/8	29	23	80	16	173	262	4027 1304 83	V
1/2	11/16	29	24,2	38	12	105	316	4027 1301 82	V
1/2	11/16	29	24,2	80	17	182	316	4027 1304 82	V
1/2	3/4	29	26,7	38	13	107	372	4027 1301 81	V
1/2	3/4	29	26,7	80	19	197	372	4027 1304 81	V
1/2	13/16	29	29,2	38	14	109	398	4027 1301 79	V
1/2	13/16	29	29,2	80	21	218	398	4027 1304 79	V
1/2	7/8	29	30,5	38	14	116	398	4027 1301 78	V
1/2	7/8	29	30,5	85	22	244	398	4027 1304 78	V
1/2	15/16	29	33	38	14	122	398	4027 1301 77	V
1/2	15/16	29	33	85	24	261	398	4027 1304 77	V
1/2	1	29	34,2	38	14	129	398	4027 1301 76	V
1/2	1,1/16	29	38,2	40	16	131	398	4027 1301 99	V
1/2	1,1/16	29	36,7	85	27	314	398	4027 1304 99	V
1/2	1,1/4	29	43	42	18	188	398	4027 1301 96	V

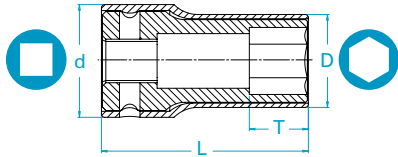

Steckschlüssel, dünnwandig, Sechskant, ROTACTION

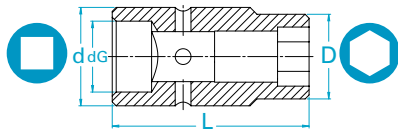

		Ø Antrieb d mm	Ø Abtrieb D mm	Länge L mm	Tiefe T mm	Gewicht g	max. Drehmoment Nm	Bestell- nummer	Steckschlüssel Abdeckung Ref.	Ersatzhülsen Bestellnummer*
Zoll	mm									
1/2	8	28	16	60	8	79	32	4027 1342 08	C28	4027 2982 52
1/2	10	28	18,5	60	10	85	103	4027 1342 10	C28	4027 2981 31
1/2	11	28	19,7	60	11	88	125	4027 1342 11	C28	4027 2982 53
1/2	12	28	21	60	12	97	148	4027 1342 12	C28	4027 2982 54
1/2	13	28	22,2	60	13	98	174	4027 1342 13	C28	4027 2981 32
1/2	14	28	23,5	60	14	102	201	4027 1342 14	C28	4027 2982 55
1/2	15	33	24,7	60	15	145	231	4027 1342 15	C33	4027 2982 56
1/2	16	33	26	60	16	142	264	4027 1342 16	C33	4027 2981 33
1/2	17	33	27,2	60	17	150	298	4027 1342 17	C33	4027 2981 34
1/2	18	33	28,5	60	18	156	334	4027 1342 18	C33	4027 2981 35
1/2	19	33	29,7	60	19	159	372	4027 1342 19	C33	4027 2981 36
1/2	21	33	32,2	60	21	178	398	4027 1342 21	C33	4027 2981 37
1/2	22	33	33,5	65	22	198	398	4027 1342 22	C33	4027 2982 57
1/2	24	33	36	65	24	220	398	4027 1342 24	C33	4027 2982 58
1/2	27	33	39,7	65	27	245	398	4027 1342 27	C33	4027 2982 59

Steckschlüssel, Sechskant, geführt





		Ø Antrieb d mm	Ø Abtrieb D mm	Ø Führung d _g mm	Länge L mm	Tiefe T mm	Gewicht g	max. Drehmoment Nm	Bestell- nummer	Stift und O-Ring Ref.
Zoll	mm									
1/2	13	25	21,5	18	50	8	110	174	4026 4313 00	W
1/2	15	25	25	18	50	8,5	116	280	4026 4315 00	W
1/2	16	26	26	18	50	10	128	350	4026 4316 00	W
1/2	17	28	28	18	50	11	151	400	4026 4317 00	V
1/2	18	28	28	18	50	10	147	455	4026 4318 00	V
1/2	19	28	28	18	50	10	142	455	4026 4319 00	V
1/2	24	25	35	18	50	12	130	455	4026 4324 00	W
in	in									
1/2	9/16	25	22	18	50	7,5	107	226	4026 4314 00	W
1/2	3/4	28	28	18	50	10	142	455	4026 4319 00	V
1/2	15/16	25	35	18	50	12	140	455	4026 4323 00	W

*Ersatzhülsen werden als 2er Satz mit Montageanleitung geliefert.

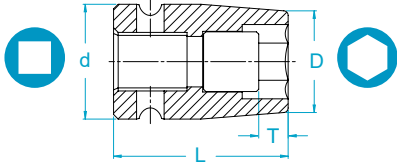

Steckschlüssel, Sechskant mit Magnet

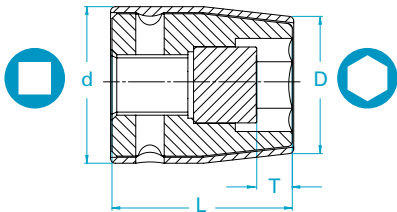

		Ø Antrieb d mm	Ø Abtrieb D mm	Länge L mm	Tiefe T mm	Gewicht g	max. Drehmoment Nm	Bestell- nummer	Stift und O-Ring Ref.
Zoll	mm								
1/2	10	25	17	38	4,2	93	103	4027 1305 10	W
1/2	11	25	18,2	38	4,9	97	125	4027 1305 11	W
1/2	12	25	19,5	38	5,6	99	148	4027 1305 12	W
1/2	13	25	20,7	38	6	102	174	4027 1305 13	W
1/2	14	25	22	38	6,4	105	201	4027 1305 14	W
1/2	15	30	23,2	38	6,8	141	280	4027 1305 15	V
1/2	16	30	24,5	38	7	145	350	4027 1305 16	V
1/2	17	30	25,7	38	7,5	145	400	4027 1305 17	V
1/2	18	30	27	38	7,8	148	455	4027 1305 18	V
1/2	19	30	28,2	38	8	147	455	4027 1305 19	V
1/2	21	30	30,7	38	8	165	455	4027 1305 21	V

Steckschlüssel, Sechskant mit Magnet, ROTACTION





		Ø Antrieb d mm	Ø Abtrieb D mm	Länge L mm	Tiefe T mm	Gewicht g	max. Drehmoment Nm	Bestell- nummer	Steckschlüssel Abdeckung Ref.	Ersatzhülsen Bestellnummer*
Zoll	mm									
1/2	10	28	20	38	4,2	97	103	4027 1360 10	C28	4027 2982 15
1/2	12	28	22,5	38	5,6	102	148	4027 1360 12	C28	4027 2982 16
1/2	13	28	23,7	38	6	104	174	4027 1360 13	C28	4027 2981 14
1/2	14	28	25	38	6,4	102	201	4027 1360 14	C28	4027 2982 17
1/2	15	33	26,2	38	6,8	143	280	4027 1360 15	C33	4027 2982 18
1/2	16	33	27,5	38	7	149	350	4027 1360 16	C33	4027 2981 15
1/2	17	33	28,7	38	7,5	149	400	4027 1360 17	C33	4027 2981 16
1/2	18	33	30	38	7,8	151	455	4027 1360 18	C33	4027 2981 17
1/2	19	33	31,2	38	8	152	455	4027 1360 19	C33	4027 2981 18
1/2	21	33	33,7	38	8	164	455	4027 1360 21	C33	4027 2982 19

*Ersatzhülsen werden als 2er Satz mit Montageanleitung geliefert.

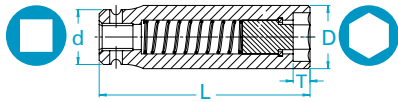
Steckschlüssel, Sechskant mit federndem Magnet*





		Ø Antrieb d mm	Ø Abtrieb D mm	Länge L mm	Tiefe T mm	Gewicht g	max. Drehmoment Nm	Bestell- nummer	Stift und O-Ring Ref.
Zoll	mm								
1/2	10	25	17	60	4,5	110	103	4027 1307 10	W
1/2	10	25	17	80	4,5	139	103	4027 1340 10	W
1/2	12	25	19,5	60	6	120	148	4027 1307 12	W
1/2	12	25	19,5	80	6	166	148	4027 1340 12	W
1/2	13	25	20,7	60	6,5	134	174	4027 1307 13	W
1/2	13	25	20,7	80	6,5	185	174	4027 1340 13	W
1/2	14	25	22	60	7	140	201	4027 1307 14	W
1/2	14	25	22	80	7	191	201	4027 1340 14	W
1/2	15	30	23,2	60	7	200	280	4027 1307 15	V
1/2	15	30	23,2	80	7	246	280	4027 1340 15	V
1/2	16	30	24,5	60	7,5	180	350	4027 1307 16	V
1/2	16	30	24,5	80	7,5	270	350	4027 1340 16	V
1/2	17	30	25,7	60	8	200	400	4027 1307 17	V
1/2	17	30	25,7	80	8	270	400	4027 1340 17	V
1/2	18	30	27	60	8,5	220	455	4027 1307 18	V
1/2	18	30	27	80	8,5	290	455	4027 1340 18	V
1/2	19	30	28,2	60	9	210	455	4027 1307 19	V
1/2	19	30	28,2	80	9	308	455	4027 1340 19	V
1/2	21	30	30,7	60	10	250	455	4027 1307 21	V
1/2	21	30	30,7	80	10	305	455	4027 1340 21	V
1/2	22	30	32	65	11	270	455	4027 1307 22	V
1/2	22	30	32	85	11	366	455	4027 1340 22	V
1/2	24	30	34,5	65	13	310	455	4027 1307 24	V
1/2	24	30	34,5	85	13	417	455	4027 1340 24	V

* Federweg ca. 20 mm

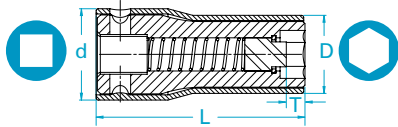
Steckschlüssel, Sechskant mit federndem Magnet*, ROTACTION



		Ø Antrieb d mm	Ø Abtrieb D mm	Länge L mm	Tiefe T mm	Gewicht g	max. Drehmoment Nm	Bestell- nummer	Steckschlüssel Abdeckung Ref.	Ersatzhülsen Bestellnummer*
Zoll	mm									
1/2	10	28	20	60	4,5	119	103	4027 1362 10	C28	4027 2981 68
1/2	10	28	20	80	4,5	160	103	4027 1365 10	C28	4027 2984 74
1/2	12	28	22,5	60	6	128	148	4027 1362 12	C28	4027 2983 80
1/2	12	28	22,5	80	6	182	148	4027 1365 12	C28	4027 2983 89
1/2	13	28	23,7	60	6,5	133	174	4027 1362 13	C28	4027 2981 66
1/2	13	28	23,7	80	6,5	190	174	4027 1365 13	C28	4027 2981 39
1/2	14	28	25	60	7	143	201	4027 1362 14	C28	4027 2983 81
1/2	14	28	25	80	7	199	201	4027 1365 14	C28	4027 2983 90
1/2	15	33	26,2	60	7	200	280	4027 1362 15	C33	4027 2981 67
1/2	15	33	26,2	80	7	250	280	4027 1365 15	C33	4027 2984 72
1/2	16	33	27,5	60	7,5	187	350	4027 1362 16	C33	4027 2983 82
1/2	16	33	27,5	80	7,5	273	350	4027 1365 16	C33	4027 2983 91
1/2	17	33	28,7	60	8	210	400	4027 1362 17	C33	4027 2983 83
1/2	17	33	28,7	80	8	271	400	4027 1365 17	C33	4027 2983 92
1/2	18	33	30	60	8,5	222	455	4027 1362 18	C33	4027 2983 84
1/2	18	33	30	80	8,5	320	455	4027 1365 18	C33	4027 2984 73
1/2	19	33	31,2	60	9	221	455	4027 1362 19	C33	4027 2983 85
1/2	19	33	31,2	80	9	334	455	4027 1365 19	C33	4027 2983 93
1/2	21	33	33,7	60	10	254	455	4027 1362 21	C33	4027 2983 86
1/2	21	33	33,7	80	10	350	455	4027 1365 21	C33	4027 2983 94
1/2	22	33	35	65	11	277	455	4027 1362 22	C33	4027 2983 87
1/2	22	33	35	85	11	370	455	4027 1365 22	C33	4027 2983 95
1/2	24	33	37,5	65	13	317	455	4027 1362 24	C33	4027 2983 88
1/2	24	33	37,5	85	13	427	455	4027 1365 24	C33	4027 2983 96

* Federweg ca. 20 mm

**Ersatzhülsen werden als 2er Satz mit Montageanleitung geliefert.

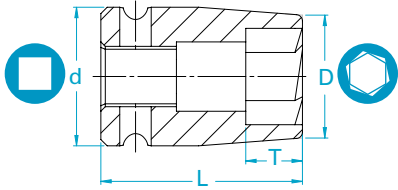

Steckschlüssel, Sechskant mit Einführschrägen



		Ø Antrieb d mm	Ø Abtrieb D mm	Länge L mm	Tiefe T mm	Gewicht g	max. Drehmoment Nm	Bestell- nummer	Stift und O-Ring Ref.
Zoll	mm								
1/2	13	25	20,7	38	9	88	174	4027 1318 13	W
1/2	13	25	20,7	80	9	170	174	4027 1319 13	W
1/2	14	25	22	38	11	86	201	4027 1318 14	W
1/2	14	25	22	80	11	178	201	4027 1319 14	W
1/2	15	30	23,2	38	11	131	280	4027 1318 15	V
1/2	15	30	23,2	80	11	237	280	4027 1319 15	V
1/2	16	30	24,5	38	11	131	350	4027 1318 16	V
1/2	16	30	24,5	80	11	245	350	4027 1319 16	V
1/2	17	30	25,7	38	12	132	400	4027 1318 17	V
1/2	17	30	25,7	80	12	263	400	4027 1319 17	V
1/2	18	30	27	38	13	128	455	4027 1318 18	V
1/2	18	30	27	80	13	268	455	4027 1319 18	V
1/2	19	30	28,2	38	13	128	455	4027 1318 19	V
1/2	19	30	28,2	80	13	270	455	4027 1319 19	V
1/2	21	30	30,7	38	14	128	455	4027 1318 21	V
1/2	21	30	30,7	80	14	287	455	4027 1319 21	V
1/2	22	30	32	38	15	132	455	4027 1318 22	V
1/2	22	30	32	85	15	314	455	4027 1319 22	V
1/2	24	30	34,5	38	15	135	455	4027 1318 24	V
1/2	24	30	34,5	85	15	335	455	4027 1319 24	V

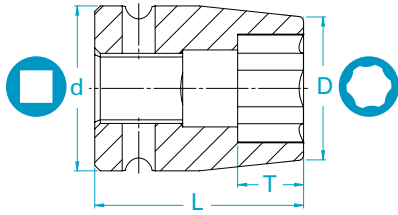

Steckschlüssel, Surface Drive



		Ø Antrieb d mm	Ø Abtrieb D mm	Länge L mm	Tiefe T mm	Gewicht g	max. Drehmoment Nm	Bestell- nummer	Stift und O-Ring Ref.
Zoll	mm								
1/2	10	25	17	38	7	85	103	4027 1308 10	W
1/2	10	25	17	80	10	136	103	4027 1310 10	W
1/2	11	25	18,2	38	8	85	125	4027 1308 11	W
1/2	11	25	18,2	80	11	148	125	4027 1310 11	W
1/2	12	25	19,5	38	9	85	148	4027 1308 12	W
1/2	12	25	19,5	80	12	156	148	4027 1310 12	W
1/2	13	25	20,7	38	10	85	174	4027 1308 13	W
1/2	13	30	19	57	12	138	174	4027 1309 13	V
1/2	13	25	20,7	80	13	158	174	4027 1310 13	W
1/2	14	25	22	38	10	86	201	4027 1308 14	W
1/2	14	25	22	80	14	170	201	4027 1310 14	W
1/2	15	30	23,2	38	11	130	280	4027 1308 15	V
1/2	15	30	23,9	57	14	164	280	4027 1309 15	V
1/2	15	30	23,2	80	15	225	280	4027 1310 15	V
1/2	16	30	24,5	38	11	130	350	4027 1308 16	V
1/2	16	30	26	57	15	172	350	4027 1309 16	V
1/2	16	30	24,5	80	16	228	350	4027 1310 16	V
1/2	17	30	25,7	38	12	130	400	4027 1308 17	V
1/2	17	30	26	57	16	173	400	4027 1309 17	V
1/2	17	30	25,7	80	17	232	400	4027 1310 17	V
1/2	18	30	27	38	13	130	455	4027 1308 18	V
1/2	18	30	28	57	16	189	455	4027 1309 18	V
1/2	18	30	27	80	18	230	455	4027 1310 18	V
1/2	19	30	28,2	38	13	125	455	4027 1308 19	V
1/2	19	30	28	57	16	182	455	4027 1309 19	V
1/2	19	30	28,2	80	19	252	455	4027 1310 19	V
1/2	21	30	30,7	38	14	128	455	4027 1308 21	V
1/2	21	30	30	57	18	175	455	4027 1309 21	V
1/2	21	30	30,7	80	21	260	455	4027 1310 21	V
1/2	22	30	32	38	14	135	455	4027 1308 22	V
1/2	22	30	32	85	22	290	455	4027 1310 22	V
1/2	24	30	34,5	38	14	135	455	4027 1308 24	V
1/2	24	30	34,5	85	24	322	455	4027 1310 24	V
1/2	27	30	38,2	40	16	160	455	4027 1308 27	V
1/2	27	30	38,2	85	27	380	455	4027 1310 27	V
1/2	30	30	42	42	17	190	455	4027 1308 30	V
1/2	30	30	42	85	30	450	455	4027 1310 30	V

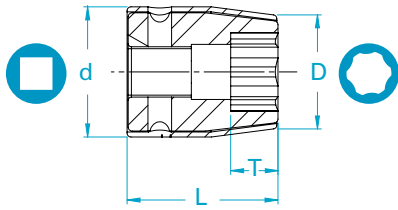

Steckschlüssel, Surface Drive, ROTACTION

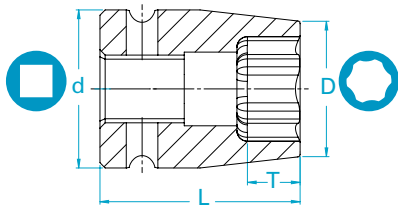

		Ø Antrieb d mm	Ø Abtrieb D mm	Länge L mm	Tiefe T mm	Gewicht g	max. Drehmoment Nm	Bestell- nummer	Steckschlüssel Abdeckung Ref.	Ersatzhülsen Bestellnummer*
Zoll	mm									
1/2	10	28	20	38	7	90	103	4027 1311 10	C28	4027 2981 19
1/2	10	28	20	80	10	143	103	4027 1371 10	C28	4027 2981 45
1/2	11	28	21,2	38	8	91	125	4027 1311 11	C28	4027 2982 32
1/2	11	28	21,2	80	11	141	125	4027 1371 11	C28	4027 2982 86
1/2	12	28	22,5	38	9	91	148	4027 1311 12	C28	4027 2984 12
1/2	12	28	22,5	80	12	151	148	4027 1371 12	C28	4027 2982 87
1/2	13	28	23,7	38	10	90	174	4027 1311 13	C28	4027 2981 20
1/2	13	28	23,7	80	13	165	174	4027 1371 13	C28	4027 2981 46
1/2	14	28	25	38	10	93	201	4027 1311 14	C28	4027 2981 84
1/2	14	28	25	80	14	166	201	4027 1371 14	C28	4027 2982 89
1/2	15	33	26,2	38	11	134	280	4027 1311 15	C33	4027 2982 34
1/2	15	33	26,2	80	15	211	280	4027 1371 15	C33	4027 2982 90
1/2	16	33	27,5	38	11	137	350	4027 1311 16	C33	4027 2981 21
1/2	16	33	27,5	80	16	236	350	4027 1371 16	C33	4027 2981 47
1/2	17	33	28,7	38	12	137	400	4027 1311 17	C33	4027 2981 22
1/2	17	33	28,7	80	17	241	400	4027 1371 17	C33	4027 2981 48
1/2	18	33	30	38	13	134	455	4027 1311 18	C33	4027 2981 23
1/2	18	33	30	80	18	241	455	4027 1371 18	C33	4027 2981 49
1/2	19	33	31,2	38	13	132	455	4027 1311 19	C33	4027 2981 24
1/2	19	33	31,2	80	19	261	455	4027 1371 19	C33	4027 2981 50
1/2	21	33	33,7	38	14	133	455	4027 1311 21	C33	4027 2981 25
1/2	21	33	33,7	80	21	269	455	4027 1371 21	C33	4027 2981 51
1/2	22	33	35	38	14	133	455	4027 1311 22	C33	4027 2982 36
1/2	22	33	35	85	22	301	455	4027 1371 22	C33	4027 2982 91
1/2	24	33	37,5	38	14	138	455	4027 1311 24	C33	4027 2982 37
1/2	24	33	37,5	85	24	327	455	4027 1371 24	C33	4027 2982 92
1/2	27	33	41,2	40	16	168	455	4027 1311 27	C33	4027 2982 38
1/2	27	33	41,2	85	27	363	455	4027 1371 27	C33	4027 2982 88

Steckschlüssel, Surface Drive, LongLife





		Ø Antrieb d mm	Ø Abtrieb D mm	Länge L mm	Tiefe T mm	Gewicht g	max. Drehmoment Nm	Bestell- nummer	Stift und O-Ring Ref.
Zoll	mm								
1/2	13	25	20,7	38	8	84	174	4027 1314 13	W
1/2	16	30	24,5	38	10	128	350	4027 1314 16	V
1/2	17	30	25,7	38	10	127	400	4027 1314 17	V
1/2	18	30	27	38	11	128	455	4027 1314 18	V
1/2	19	30	28,2	38	11	126	455	4027 1314 19	V
1/2	21	30	30	38	12	120	455	4027 1314 21	V

*Ersatzhülsen werden als 2er Satz mit Montageanleitung geliefert.

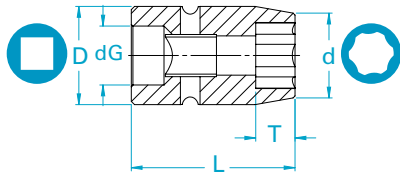
Steckschlüssel, Surface Drive, geführt



		Ø Antrieb d mm	Ø Abtrieb D mm	Ø Führung d _G mm	Länge L mm	Tiefe T mm	Gewicht g	max. Drehmoment Nm	Bestell- nummer	Stift und O-Ring Ref.
Zoll	mm									
1/2	10	25	17	18	50	7	102	103	4027 1312 10	W
1/2	10	25	17	18	100	10	200	103	4027 1313 10	W
1/2	12	25	19,5	18	50	9	112	148	4027 1312 12	W
1/2	12	25	19,5	18	100	12	215	148	4027 1313 12	W
1/2	13	25	20,7	18	50	10	112	174	4027 1312 13	W
1/2	13	25	20,7	18	100	13	220	174	4027 1313 13	W
1/2	14	25	22	18	50	10	112	201	4027 1312 14	W
1/2	14	25	22	18	100	14	225	201	4027 1313 14	W
1/2	16	30	24,5	18	50	11	175	350	4027 1312 16	V
1/2	16	30	24,5	18	100	16	230	350	4027 1313 16	V
1/2	17	30	25,7	18	50	12	176	400	4027 1312 17	V
1/2	17	30	25,7	18	100	17	250	400	4027 1313 17	V
1/2	19	30	28,2	18	50	13	176	455	4027 1312 19	V
1/2	19	30	28,2	18	100	19	275	455	4027 1313 19	V

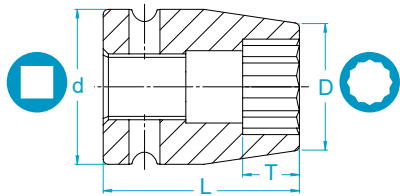

Steckschlüssel, Doppelsechskant

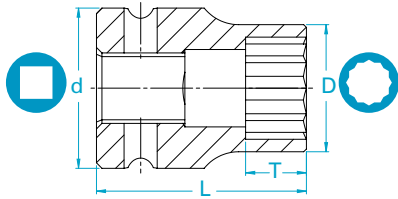

		Ø Antrieb d mm	Ø Abtrieb D mm	Länge L mm	Tiefe T mm	Gewicht g	max. Drehmoment Nm	Bestell- nummer	Stift und O-Ring Ref.
Zoll	mm								
1/2	10	25	17	38	7	86	103	4027 1315 10	W
1/2	10	25	17	80	10	140	103	4027 1317 10	W
1/2	11	25	18,2	38	8	84	125	4027 1315 11	W
1/2	11	25	18,2	80	11	156	125	4027 1317 11	W
1/2	12	25	19,5	38	9	84	148	4027 1315 12	W
1/2	12	25	19,5	80	12	162	148	4027 1317 12	W
1/2	13	25	20,7	38	10	84	174	4027 1315 13	W
1/2	13	25	20,7	80	13	162	174	4027 1317 13	W
1/2	14	25	22	38	10	84	201	4027 1315 14	W
1/2	14	25	22	80	14	174	201	4027 1317 14	W
1/2	15	30	23,2	38	11	130	280	4027 1315 15	V
1/2	15	30	23,2	80	15	220	280	4027 1317 15	V
1/2	16	30	24,5	38	11	127	350	4027 1315 16	V
1/2	16	30	24,5	80	16	232	350	4027 1317 16	V
1/2	17	30	25,7	38	12	128	400	4027 1315 17	V
1/2	17	30	25,7	80	17	232	400	4027 1317 17	V
1/2	18	30	27	38	13	130	455	4027 1315 18	V
1/2	18	30	27	80	18	232	455	4027 1317 18	V
1/2	19	30	28,2	38	13	125	455	4027 1315 19	V
1/2	19	30	28,2	80	19	259	455	4027 1317 19	V
1/2	21	30	30,7	38	14	128	455	4027 1315 21	V
1/2	21	30	30,7	80	21	265	455	4027 1317 21	V
1/2	22	30	32	38	14	130	455	4027 1315 22	V
1/2	22	30	32	85	22	290	455	4027 1317 22	V
1/2	24	30	34,5	38	14	133	455	4027 1315 24	V
1/2	24	30	34,5	85	24	329	455	4027 1317 24	V
1/2	27	30	38,2	40	16	157	455	4027 1315 27	V
1/2	27	30	38,2	85	27	385	455	4027 1317 27	V
1/2	30	30	42	42	17	190	455	4027 1315 30	V
1/2	30	30	42	85	30	457	455	4027 1317 30	V
1/2	32	30	44,5	42	18	216	455	4027 1315 32	V
1/2	32	30	44,5	85	32	542	455	4027 1317 32	V

Steckschlüssel, dünnwandig, Doppelsechskant



		Ø Antrieb d mm	Ø Abtrieb D mm	Länge L mm	Tiefe T mm	Gewicht g	max. Drehmoment Nm	Bestell- nummer	Stift und O-Ring Ref.
Zoll	mm								
1/2	10	24	15,5	38	7	62	103	4027 1316 10	W
1/2	11	24	16,7	38	8	62	125	4027 1316 11	W
1/2	12	24	18	38	9	63	148	4027 1316 12	W
1/2	13	24	19,2	38	10	66	174	4027 1316 13	W
1/2	14	24	20,5	38	10	67	201	4027 1316 14	W
1/2	15	29	21,7	38	11	102	231	4027 1316 15	V
1/2	16	29	23	38	11	102	264	4027 1316 16	V
1/2	17	29	24,2	38	12	105	298	4027 1316 17	V
1/2	18	29	25,5	38	13	105	334	4027 1316 18	V
1/2	19	29	26,7	38	13	107	372	4027 1316 19	V
1/2	21	29	29,2	38	14	109	398	4027 1316 21	V
1/2	22	29	30,5	38	14	113	398	4027 1316 22	V
1/2	24	29	33	38	14	122	398	4027 1316 24	V
1/2	27	29	36,7	40	16	145	398	4027 1316 27	V
1/2	30	29	40,5	42	17	178	398	4027 1316 30	V
1/2	32	29	43	42	18	188	398	4027 1316 32	V

Steckschlüssel, für Torx®-Schrauben

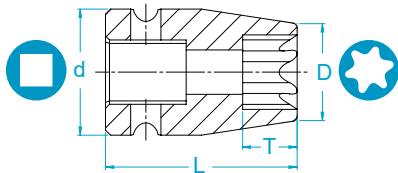

		Ø Antrieb d mm	Ø Abtrieb D mm	Länge L mm	Tiefe T mm	Gewicht g	max. Drehmoment Nm	Bestell- nummer	Stift und O-Ring Ref.
Zoll									
1/2	E10	25	14,2	38	7,2	86	62	4027 1320 10	W
1/2	E10	25	14,2	80	7,2	136	62	4027 1321 10	W
1/2	E12	25	15,2	38	8,3	85	129	4027 1320 12	W
1/2	E12	25	15,2	80	8,3	141	129	4027 1321 12	W
1/2	E14	25	18,2	38	9,6	88	153	4027 1320 14	W
1/2	E14	25	18,2	80	9,6	147	153	4027 1321 14	W
1/2	E16	25	19,2	38	10,8	86	233	4027 1320 16	W
1/2	E16	25	19,2	80	10,8	151	233	4027 1321 16	W
1/2	E18	25	22,2	38	12	88	327	4027 1320 18	W
1/2	E18	25	22,2	80	12	218	327	4027 1321 18	W
1/2	E20	30	24,2	38	13,4	136	455	4027 1320 20	V
1/2	E20	30	24,2	80	13,4	225	455	4027 1321 20	V

Torx®, Torx Plus® sind eingetragene Warenzeichen von Acument Intellectual Properties, LLC.

Steckschlüssel, für Torx®-Schrauben, ROTACTION

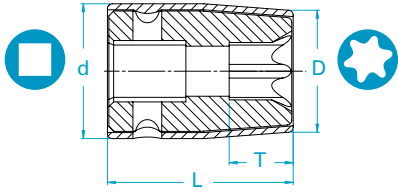

		Ø Antrieb d mm	Ø Abtrieb D mm	Länge L mm	Tiefe T mm	Gewicht g	max. Drehmoment Nm	Bestell- nummer	Steckschlüssel Abdeckung Ref.	Ersatzhülsen Bestellnummer*
Zoll										
1/2	E10	28	17,3	38	7,2	90	62	4027 1364 10	C28	4027 2981 26
1/2	E10	28	17,2	80	7,2	125	62	4027 1381 10	C28	4027 2982 94
1/2	E12	28	18,2	38	8,3	89	129	4027 1364 12	C28	4027 2981 27
1/2	E12	28	18,2	80	8,3	120	129	4027 1381 12	C28	4027 2981 80
1/2	E14	28	21,2	38	9,6	92	153	4027 1364 14	C28	4027 2981 28
1/2	E14	28	21,2	80	9,6	150	153	4027 1381 14	C28	4027 2981 77
1/2	E16	28	22,2	38	10,8	92	233	4027 1364 16	C28	4027 2981 29
1/2	E18	28	25,2	38	12	93	327	4027 1364 18	C28	4027 2981 30
1/2	E20	33	27,2	38	13,4	140	455	4027 1364 20	C33	4027 2982 40

Steckschlüssel, für Torx®-Schrauben mit Magnet

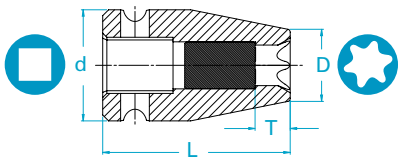

		Ø Antrieb d mm	Ø Abtrieb D mm	Länge L mm	Tiefe T mm	Gewicht g	max. Drehmoment Nm	Bestell- nummer	Stift und O-Ring Ref.
Zoll									
1/2	E10	25	14,2	38	6	90	62	4027 1380 10	W
1/2	E12	25	15,2	38	6	90	129	4027 1380 12	W
1/2	E14	25	18,2	38	7,5	94	153	4027 1380 14	W
1/2	E16	25	19,2	38	8,5	95	233	4027 1380 16	W
1/2	E18	25	22,2	38	9,5	100	327	4027 1380 18	W
1/2	E20	30	24,2	38	11	146	455	4027 1380 20	V

Steckschlüssel, für Torx®-Schrauben mit Magnet, ROTACTION

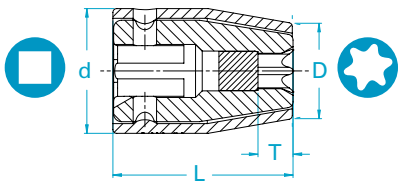

		Ø Antrieb d mm	Ø Abtrieb D mm	Länge L mm	Tiefe T mm	Gewicht g	max. Drehmoment Nm	Bestell- nummer	Steckschlüssel Abdeckung Ref.	Ersatzhülsen Bestellnummer*
Zoll										
1/2	E10	28	17,2	38	6	83	62	4027 1380 60	C28	4027 2983 59
1/2	E12	28	18,2	38	6	93	129	4027 1380 62	C28	4027 2983 60
1/2	E14	28	21,2	38	7,5	98	153	4027 1380 64	C28	4027 2983 61
1/2	E16	28	22,2	38	8,5	94	233	4027 1380 66	C28	4027 2983 62
1/2	E18	28	25,2	38	9,5	98	327	4027 1380 68	C28	4027 2983 63
1/2	E20	33	27,2	38	11	147	455	4027 1380 70	C33	4027 2983 64

*Ersatzhülsen werden als 2er Satz mit Montageanleitung geliefert.

Torx®, Torx Plus® sind eingetragene Warenzeichen von Acument Intellectual Properties, LLC.

Steckschlüssel, für TorxPlus®-Schrauben

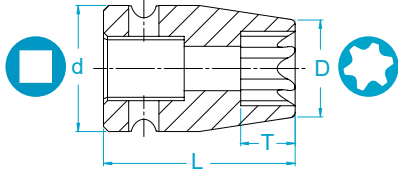

		Ø Antrieb d mm	Ø Abtrieb D mm	Länge L mm	Tiefe T mm	Gewicht g	max. Drehmoment Nm	Bestell- nummer	Stift und O-Ring Ref.
Zoll									
1/2	10EPL	25	14,5	38	5,2	86	79	4027 1322 10	W
1/2	12EPL	25	17	38	6,2	86	161	4027 1322 12	W
1/2	14EPL	25	18,2	38	7,1	88	192	4027 1322 14	W
1/2	16EPL	25	20,7	38	8,2	88	292	4027 1322 16	W
1/2	18EPL	25	22	40	9,2	90	409	4027 1322 18	W
1/2	20EPL	30	24,5	42	10,2	135	455	4027 1322 20	V

Gelenkschlüssel, Sechskant**



		Ø Antrieb d mm	Ø Abtrieb D mm	Länge L mm	Tiefe T mm	Gewicht g	Bestell- nummer	Stift und O-Ring Ref.
Zoll	mm							
1/2	13	25	23,8	57	8	137	4027 1331 13	W
1/2	13	25	23,8	100	8	165	4027 1332 13	W
1/2	13	25	23,8	150	8	215	4027 1333 13	W
1/2	14	25	25,2	60	9	154	4027 1331 14	W
1/2	14	25	25,2	100	9	190	4027 1332 14	W
1/2	14	25	25,2	150	9	230	4027 1333 14	W
1/2	15	30	26,6	64	9	203	4027 1331 15	V
1/2	15	30	26,6	100	9	258	4027 1332 15	V
1/2	15	30	26,6	150	9	297	4027 1333 15	V
1/2	16	30	29,4	66	10	242	4027 1331 16	V
1/2	16	30	29,4	100	10	297	4027 1332 16	V
1/2	16	30	29,4	150	10	344	4027 1333 16	V
1/2	17	30	29,4	66	10	244	4027 1331 17	V
1/2	17	30	29,4	100	10	300	4027 1332 17	V
1/2	17	30	29,4	150	10	347	4027 1333 17	V
1/2	18	30	32,2	70	12	285	4027 1331 18	V
1/2	18	30	32,2	100	12	341	4027 1332 18	V
1/2	18	30	32,2	150	12	402	4027 1333 18	V
1/2	19	30	32,2	70	12	285	4027 1331 19	V
1/2	19	30	32,2	100	12	336	4027 1332 19	V
1/2	19	30	32,2	150	12	397	4027 1333 19	V
in	in							
1/2	1/2	25	23,8	100	8	170	4027 1332 86	W
1/2	9/16	25	25,2	100	9	185	4027 1332 84	W
1/2	5/8	30	29,4	100	10	302	4027 1332 83	V
1/2	11/16	30	29,4	100	10	294	4027 1332 82	V
1/2	3/4	30	32,2	100	12	336	4027 1332 81	V

Torx®, Torx Plus® sind eingetragene Warenzeichen von Acument Intellectual Properties, LLC.

**Aufgrund der Drehmomentbegrenzungen für Universal-Steckschlüssel wird die stattdessen Verwendung eines Pendeladapters mit Steckschlüssel empfohlen.

Bit Steckschlüssel, für Innensechskant-Schrauben

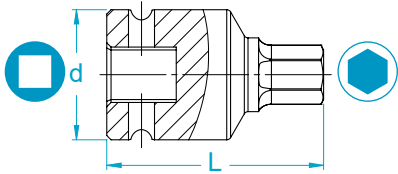

		Ø Antrieb d mm	Länge L mm	Gewicht g	max. Drehmoment Nm	Bestell- nummer	Stift und O-Ring Ref.
Zoll	mm						
1/2	6	25	42	79	43	4027 1323 06	W
1/2	7	25	42	81	68	4027 1323 07	W
1/2	8	25	42	81	98	4027 1323 08	W
1/2	10	25	44	89	179	4027 1323 10	W
1/2	12	30	50	161	336	4027 1323 12	V
1/2	14	30	50	162	455	4027 1323 14	V
1/2	17	30	50	176	455	4027 1323 17	V

Bit Steckschlüssel, für Innensechskant-Schrauben, geführt

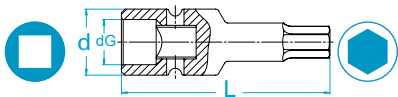

		Ø Antrieb d mm	Ø Führung d _g mm	Länge L mm	Gewicht g	max. Drehmoment Nm	Bestell- nummer	Stift und O-Ring Ref.
in	mm							
1/2	8	25	18	60	105	98	4027 1389 08	W
1/2	10	25	18	60	112	179	4027 1389 10	W
1/2	12	30	18	60	200	336	4027 1389 12	W

Bit Steckschlüssel, für Torx®-Schrauben

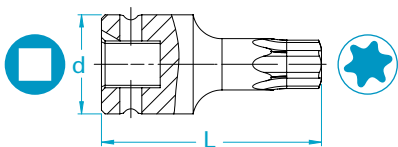

		Ø Antrieb d mm	Länge L mm	Gewicht g	max. Drehmoment Nm	Bestell- nummer	Stift und O-Ring Ref.
Zoll							
1/2	T30	25	60	77	26	4027 1326 30	W
1/2	T30	25	100	94	26	4027 1327 30	W
1/2	T30	25	150	114	26	4027 1328 30	W
1/2	T40	25	60	85	46	4027 1326 40	W
1/2	T40	25	100	100	46	4027 1327 40	W
1/2	T40	25	150	119	46	4027 1328 40	W
1/2	T45	25	60	86	72	4027 1326 45	W
1/2	T45	25	100	101	72	4027 1327 45	W
1/2	T45	25	150	120	72	4027 1328 45	W
1/2	T50	25	60	90	111	4027 1326 50	W
1/2	T50	25	100	115	111	4027 1327 50	W
1/2	T50	25	150	147	111	4027 1328 50	W
1/2	T55	27	60	116	180	4027 1326 55	V
1/2	T55	27	100	151	180	4027 1327 55	V
1/2	T55	27	150	194	180	4027 1328 55	V
1/2	T60	27	60	128	312	4027 1326 60	V
1/2	T60	27	100	176	312	4027 1327 60	V
1/2	T60	27	150	237	312	4027 1328 60	V

Torx®, Torx Plus® sind eingetragene Warenzeichen von Acument Intellectual Properties, LLC.

Bit Steckschlüssel, für Torx®-Schrauben, ROTACTION

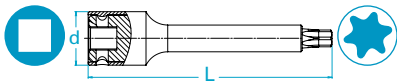

		Ø Antrieb d mm	Länge L mm	Gewicht g	max. Drehmoment Nm	Bestell- nummer	Steckschlüssel Abdeckung Ref.	Ersatzhülsen Bestellnummer*
Zoll								
1/2	T30	28	60	86	26	4027 1372 30	C28	4027 2983 41
1/2	T30	28	100	100	26	4027 1356 30	C28	4027 2983 36
1/2	T30	28	150	116	26	4027 1373 30	C28	4027 2983 44
1/2	T40	28	60	89	46	4027 1372 40	C28	4027 2983 42
1/2	T40	28	100	106	46	4027 1356 40	C28	4027 2983 37
1/2	T40	28	150	128	46	4027 1373 40	C28	4027 2983 45
1/2	T45	28	60	99	72	4027 1372 45	C28	4027 2981 73
1/2	T45	28	100	107	72	4027 1356 45	C28	4027 2983 38
1/2	T45	28	150	129	72	4027 1373 45	C28	4027 2983 46
1/2	T50	28	60	100	111	4027 1372 50	C28	4027 2981 70
1/2	T50	28	100	123	111	4027 1356 50	C28	4027 2983 39
1/2	T50	28	150	156	111	4027 1373 50	C28	4027 2983 47
1/2	T55	33	60	122	180	4027 1372 55	C33	4027 2983 43
1/2	T55	33	100	157	180	4027 1356 55	C33	4027 2983 40
1/2	T55	33	150	201	180	4027 1373 55	C33	4027 2983 48

Bit Steckschlüssel, für Torx®-Schrauben mit Ringmagnet, ROTACTION

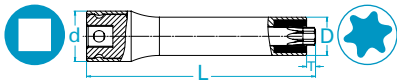



		Ø Antrieb d mm	Ø Abtrieb D mm	Länge L mm	Tiefe T mm	Gewicht g	max. Drehmoment Nm	Bestell- nummer	Steckschlüssel Abdeckung Ref.
Zoll									
1/2	T30	28	13,7	60	3,2	88	26	4027 1326 31	C28
1/2	T30	28	13,7	100	3,2	104	26	4027 1327 31	C28
1/2	T30	28	13,7	150	3,2	124	26	4027 1328 31	C28
1/2	T40	28	16,7	60	3,4	92	46	4027 1326 41	C28
1/2	T40	28	16,7	100	3,4	114	46	4027 1327 41	C28
1/2	T40	28	16,7	150	3,4	141	46	4027 1328 41	C28
1/2	T45	28	16,7	60	3,9	93	72	4027 1326 46	C28
1/2	T45	28	16,7	100	3,9	115	72	4027 1327 46	C28
1/2	T45	28	16,7	150	3,9	142	72	4027 1328 46	C28
1/2	T50	28	19,7	60	4,6	120	111	4027 1326 51	C28
1/2	T50	28	19,7	100	4,6	160	111	4027 1327 51	C28
1/2	T50	28	19,7	150	4,6	205	111	4027 1328 51	C28
1/2	T55	33	22,2	60	5,1	127	180	4027 1326 56	C33
1/2	T55	33	22,2	100	5,1	170	180	4027 1327 56	C33
1/2	T55	33	22,2	150	5,1	270	180	4027 1328 56	C33

*Ersatzhülsen werden als 2er Satz mit Montageanleitung geliefert.

Torx®, Torx Plus® sind eingetragene Warenzeichen von Acument Intellectual Properties, LLC.

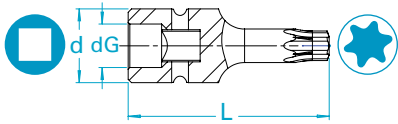

Bit Steckschlüssel, für Torx®-Schrauben, geführt



		Ø Antrieb d mm	Ø Führung d _G mm	Länge L mm	Gewicht g	max. Drehmoment Nm	Bestell- nummer	Stift und O-Ring Ref.
Zoll	mm							
1/2	T30	25	18	70	97	26	4027 1329 30	W
1/2	T30	25	18	110	111	26	4027 1330 30	W
1/2	T40	25	18	70	104	46	4027 1329 40	W
1/2	T40	25	18	110	119	46	4027 1330 40	W
1/2	T45	25	18	70	106	72	4027 1329 45	W
1/2	T45	25	18	110	120	72	4027 1330 45	W
1/2	T50	25	18	70	109	111	4027 1329 50	W
1/2	T50	25	18	110	134	111	4027 1330 50	W
1/2	T55	27	18	70	144	180	4027 1329 55	V
1/2	T55	27	18	110	180	180	4027 1330 55	V
1/2	T60	27	18	70	154	312	4027 1329 60	V
1/2	T60	27	18	110	203	312	4027 1330 60	V

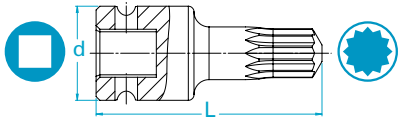

Bit Steckschlüssel, für XZN-Schrauben

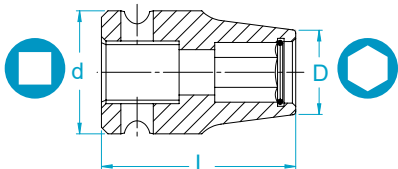

		Ø Antrieb d mm	Länge L mm	Gewicht g	max. Drehmoment Nm	Bestell- nummer	Stift und O-Ring Ref.
Zoll							
1/2	08	25	60	71	43	4027 1324 08	W
1/2	08	25	125	105	43	4027 1325 08	W
1/2	10	25	60	93	98	4027 1324 10	W
1/2	10	25	125	153	98	4027 1325 10	W
1/2	12	25	60	110	154	4027 1324 12	W
1/2	12	25	125	173	154	4027 1325 12	W
1/2	14	25	60	110	259	4027 1324 14	W
1/2	14	25	125	179	259	4027 1325 14	W

Bithalter, Vierkantantrieb, für Bits mit Sechskant Form C



		Ø Antrieb d mm	Ø Abtrieb D mm	Länge L mm	Gewicht g	Bestell- nummer	Stift und O-Ring Ref.
Zoll	Zoll						
1/2	1/4	25	11	35	60	4027 1335 00	W
1/2	5/16	25	14	35	62	4027 1335 01	W

Bithalter, Vierkanttrieb, für Bits mit Sechskant Form C, ROTACTION

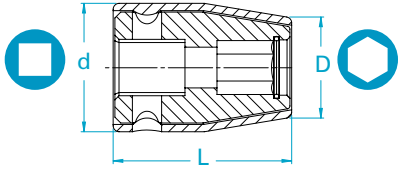

		Ø Antrieb d mm	Ø Abtrieb D mm	Länge L mm	Gewicht g	Bestell- nummer	Steckschlüssel Abdeckung Ref.	Ersatzhülsen Bestellnummer*
Zoll	Zoll							
1/2	1/4	28	14	35	69	4027 1335 70	C28	4027 2984 86
1/2	5/16	28	17	38	68	4027 1335 71	C28	4027 2980 86

Bithalter, Vierkanttrieb, für Bits mit Sechskant Form C mit Magnet

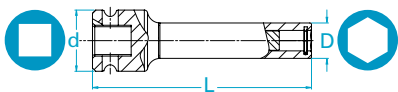

		Ø Antrieb d mm	Ø Abtrieb D mm	Länge L mm	Gewicht g	Bestell- nummer	Stift und O-Ring Ref.
Zoll	Zoll						
1/2	1/4	25	11	70	80	4027 1335 90	W
1/2	5/16	25	14	70	100	4027 1335 92	W

Bithalter, Vierkanttrieb, für Bits mit Sechskant Form C mit Magnet, ROTACTION

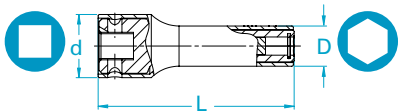

		Ø Antrieb d mm	Ø Abtrieb D mm	Länge L mm	Gewicht g	Bestell- nummer	Steckschlüssel Abdeckung Ref.	Ersatzhülsen Bestellnummer*
Zoll	Zoll							
1/2	1/4	28	14	70	95	4027 1335 80	C28	4027 2984 96
1/2	5/16	28	17	70	105	4027 1335 82	C28	4027 2984 97

Bithalter, Vierkanttrieb, für 11 mm Sechskant-Bits

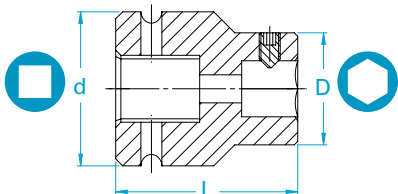



		Ø Antrieb d mm	Ø Abtrieb D mm	Länge L mm	Gewicht g	Bestell- nummer	Stift und O-Ring Ref.
Zoll	mm						
1/2	11	30	22	38	126	4027 1335 10	V

*Ersatzhülsen werden als 2er Satz mit Montageanleitung geliefert.

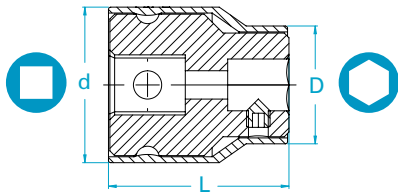

Bithalter, Vierkanttrieb, für 11 mm Sechskant-Bits, ROTACTION



		Ø Antrieb d mm	Ø Abtrieb D mm	Länge L mm	Gewicht g	Bestell- nummer	Steckschlüssel Abdeckung Ref.	Ersatzhülsen Bestellnummer*
Zoll	mm							
1/2	11	33	25	38	130	4027 1335 15	C33	4027 2984 75

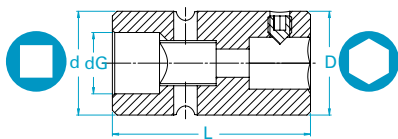

Bithalter, Vierkanttrieb, für 11 mm Sechskant-Bits, geführt

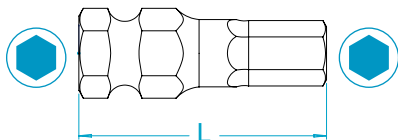

		Ø Antrieb d mm	Ø Abtrieb D mm	Ø Führung d _G mm	Länge L mm	Gewicht g	Bestell- nummer	Stift und O-Ring Ref.
Zoll	mm							
1/2	11	30	22	18	48	160	4027 1390 10	V

Bits, mit 11 mm Sechskantantrieb, für Innensechskant-Schrauben





		Länge L mm	Gewicht g	max. Drehmoment Nm	Bestell- nummer
mm	mm				
11	4	35	16	13	4027 1250 04
11	5	35	16	25	4027 1250 05
11	6	35	18	43	4027 1250 06
11	7	35	20	68	4027 1250 07
11	8	35	22	98	4027 1250 08
11	10	35	26	179	4027 1250 10
11	12	35	31	229	4027 1250 12
11	14	35	36	229	4027 1250 14
11	17	35	50	229	4027 1250 17
11	19	35	56	229	4027 1250 19

*Ersatzhülsen werden als 2er Satz mit Montageanleitung geliefert.

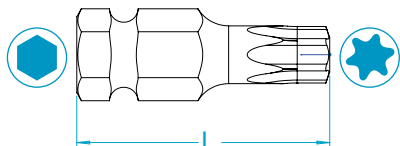

Bits, mit 11 mm Sechskantantrieb, für Torx®-Schrauben



		Länge L mm	Gewicht g	max. Drehmoment Nm	Bestell- nummer
mm					
11	T30	35	18	26	4027 1252 30
11	T40	35	20	46	4027 1252 40
11	T45	35	22	72	4027 1252 45
11	T50	35	26	111	4027 1252 50
11	T55	35	31	180	4027 1252 55
11	T60	35	38	312	4027 1252 60

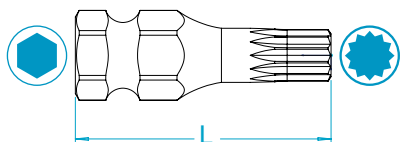

Bits, mit 11 mm Sechskantantrieb, für XZN-Schrauben



		Länge L mm	Gewicht g	max. Drehmoment Nm	Bestell- nummer
mm					
11	04	35	20	5,3	4027 1251 04
11	05	35	20	13	4027 1251 05
11	06	35	22	25	4027 1251 06
11	08	35	26	43	4027 1251 08
11	10	35	31	98	4027 1251 10
11	12	35	38	154	4027 1251 12

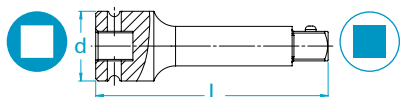

Verlängerung, Außenvierkant mit Stiftarretierung



		Ø Antrieb d mm	Länge L mm	Gewicht g	Bestell- nummer	Stift und O-Ring Ref.
Zoll	Zoll					
1/2	1/2	30	50	144	4027 1334 00	V
1/2	1/2	30	75	188	4027 1334 01	V
1/2	1/2	30	100	231	4027 1334 02	V
1/2	1/2	30	125	272	4027 1334 03	V
1/2	1/2	30	150	314	4027 1334 04	V
1/2	1/2	30	200	397	4027 1334 06	V
1/2	1/2	30	250	480	4027 1334 07	V
1/2	1/2	30	300	563	4027 1334 09	V

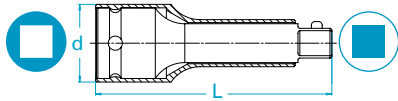

Verlängerung, Außenvierkant mit Stiftarretierung, ROTACTION

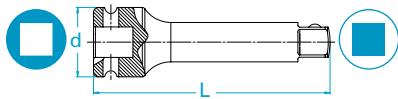

		Ø Antrieb d mm	Länge L mm	Gewicht g	Bestell- nummer	Steckschlüssel Abdeckung Ref.	Ersatzhülsen Bestellnummer*
Zoll	Zoll						
1/2	1/2	33	50	150	4027 1334 20	C33	4027 2980 37
1/2	1/2	33	75	192	4027 1334 21	C33	4027 2980 38
1/2	1/2	33	100	235	4027 1334 22	C33	4027 2980 39
1/2	1/2	33	125	277	4027 1334 23	C33	4027 2980 40
1/2	1/2	33	150	319	4027 1334 24	C33	4027 2980 41
1/2	1/2	33	200	406	4027 1334 26	C33	4027 2980 42
1/2	1/2	33	250	489	4027 1334 27	C33	4027 2980 43
1/2	1/2	33	300	572	4027 1334 29	C33	4027 2983 65

Verlängerung, Außenvierkant mit Kugelarretierung**





		Ø Antrieb d mm	Länge L mm	Gewicht g	Bestell- nummer	Stift und O-Ring Ref.
Zoll	Zoll					
1/2	1/2	30	50	144	4027 1334 40	V
1/2	1/2	30	75	188	4027 1334 41	V
1/2	1/2	30	100	231	4027 1334 42	V
1/2	1/2	30	125	272	4027 1334 43	V
1/2	1/2	30	150	314	4027 1334 44	V
1/2	1/2	30	200	397	4027 1334 46	V
1/2	1/2	30	250	480	4027 1334 47	V
1/2	1/2	30	300	563	4027 1334 49	V

Vierkanttrieb
1/2"

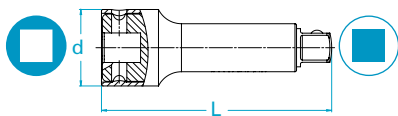
Verlängerung, Außenvierkant mit Kugelarretierung, ROTACTION





		Ø Antrieb d mm	Länge L mm	Gewicht g	Bestell- nummer	Steckschlüssel Abdeckung Ref.	Ersatzhülsen Bestellnummer*
Zoll	Zoll						
1/2	1/2	33	50	150	4027 1334 30	C33	4027 2984 21
1/2	1/2	33	75	192	4027 1334 31	C33	4027 2984 22
1/2	1/2	33	100	235	4027 1334 32	C33	4027 2984 23
1/2	1/2	33	125	277	4027 1334 33	C33	4027 2984 24
1/2	1/2	33	150	319	4027 1334 34	C33	4027 2984 25
1/2	1/2	33	200	406	4027 1334 36	C33	4027 2984 26
1/2	1/2	33	250	489	4027 1334 37	C33	4027 2984 27
1/2	1/2	33	300	572	4027 1334 39	C33	4027 2984 28

*Ersatzhülsen werden als 2er Satz mit Montageanleitung geliefert.

**Das an einem Vierkanttrieb mit Kugelarretierung angebrachte Gewicht darf 1 kg nicht überschreiten.

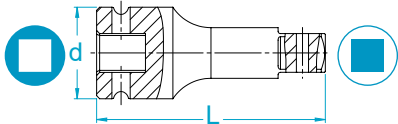

Verlängerung, Außenvierkant mit Durchgangsbohrung



		Ø Antrieb d mm	Länge L mm	Gewicht g	Bestell- nummer	Stift und O-Ring Ref.
Zoll	Zoll					
1/2	1/2	30	75	188	4027 1334 11	V
1/2	1/2	30	100	230	4027 1334 12	V
1/2	1/2	30	125	272	4027 1334 13	V
1/2	1/2	30	150	314	4027 1334 14	V
1/2	1/2	30	200	397	4027 1334 16	V
1/2	1/2	30	250	480	4027 1334 17	V



Verlängerung, Außenvierkant mit Durchgangsbohrung, geführt

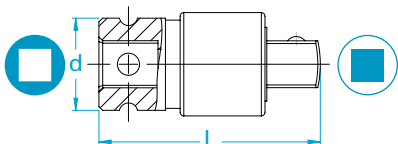

		Ø Antrieb d mm	Ø Führung d _g mm	Länge L mm	Gewicht g	Bestell- nummer	Stift und O-Ring Ref.
Zoll	Zoll						
1/2	1/2	26	16	75	161	4023 3602 02	W
1/2	1/2	26	16	100	199	4023 3602 01	W
1/2	1/2	26	16	150	275	4023 3603 01	W
1/2	1/2	26	16	200	337	4023 3604 01	W
1/2	1/2	26	16	250	434	4023 3614 01	W
1/2	1/2	26	16	300	513	4023 3615 01	W
1/2	1/2	26	18	75	165	4023 3605 02	W
1/2	1/2	26	18	100	212	4023 3605 01	W
1/2	1/2	26	18	150	311	4023 3606 01	W
1/2	1/2	26	18	200	412	4023 3607 01	W
1/2	1/2	26	18	250	506	4023 3616 01	W
1/2	1/2	26	18	300	611	4023 3617 01	W

Schnellwechselfutter, für Vierkantantriebe



		Ø Antrieb d mm	Länge L mm	Gewicht g	Bestell- nummer	Stift und O-Ring Ref.
Zoll	Zoll					
1/2	1/2	25	60	128	4027 1336 10	W

Schnellwechselfutter, für Vierkantantriebe, ROTACTION

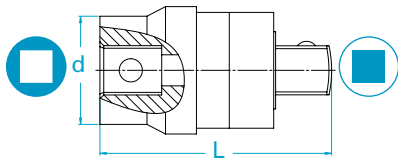

		Ø Antrieb d mm	Länge L mm	Gewicht g	Bestell- nummer	Steckschlüssel Abdeckung Ref.
Zoll	Zoll					
1/2	1/2	28	60	150	4027 1336 30	C28

Gelenk Adapter, Außenvierkant mit Stiftarretierung

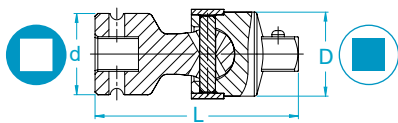

		Ø Antrieb d mm	Ø Abtrieb D mm	Länge L mm	Gewicht g	Bestell- nummer	Stift und O-Ring Ref.
Zoll	Zoll						
1/2	1/2	30	28	74	210	4027 1335 40	V

Wobble Adapter mit Feder

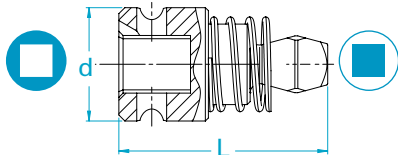

		Ø Antrieb d mm	Länge L mm	Gewicht g	max. Drehmoment Nm	Bestell- nummer	Stift und O-Ring Ref.
Zoll	Zoll						
1/2	1/2	25	50	95	132	4027 1335 50	W

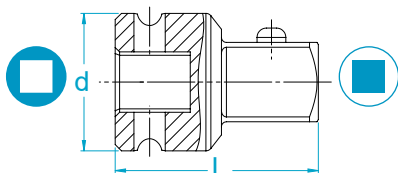

Adapter, Außenvierkant mit Stiftarretierung



		Ø Antrieb d mm	Länge L mm	Gewicht g	Bestell- nummer	Stift und O-Ring Ref.
Zoll	Zoll					
1/2	3/8	25	37,5	68	4027 1335 30	W

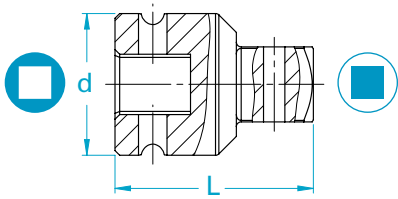

Adapter, Außenvierkant mit Durchgangsbohrung



		Ø Antrieb d mm	Länge L mm	Gewicht g	Bestell- nummer	Stift und O-Ring Ref.
Zoll	Zoll					
1/2	3/8	25	37,5	68	4027 1335 20	W
1/2	5/8	30	42	135	4027 1335 21	V
1/2	3/4	30	44	146	4027 1335 22	V

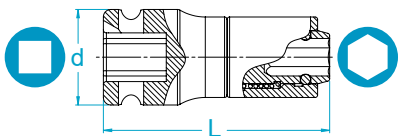

Schnellwechselfutter, Vierkantantrieb, für Bits mit Sechskant Form C



		Ø Antrieb d mm	Länge L mm	Gewicht g	Bestell- nummer	Stift und O-Ring Ref.
Zoll	Zoll					
1/2	1/4	25	55	97	4027 1336 00	W

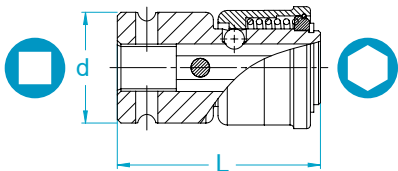

Schnellwechselfutter, Vierkantantrieb, für Bits mit Sechskant Form E



		Ø Antrieb d mm	Länge L mm	Gewicht g	Bestell- nummer	Stift und O-Ring Ref.
Zoll	Zoll					
1/2	7/16	30	55	216	4027 1336 03	V

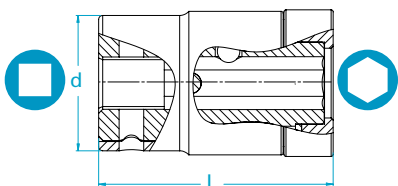

Schnellwechselfutter, Vierkantantrieb, für Bits mit Sechskant Form E, ROTACTION

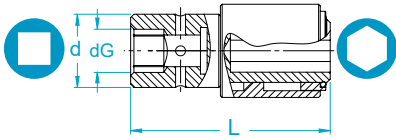

		Ø Antrieb d mm	Länge L mm	Gewicht g	Bestell- nummer	Stift und O-Ring Ref.
Zoll	Zoll					
1/2	7/16	33	55	200	4027 1336 23	C33

Schnellwechselfutter, Vierkantantrieb, für Bits mit Sechskant Form E, geführt



		Ø Antrieb d mm	Ø Führung d _G mm	Länge L mm	Gewicht g	Bestell- nummer	Stift und O-Ring Ref.
Zoll	Zoll						
1/2	7/16	28	18	68	216	4026 4503 00	V

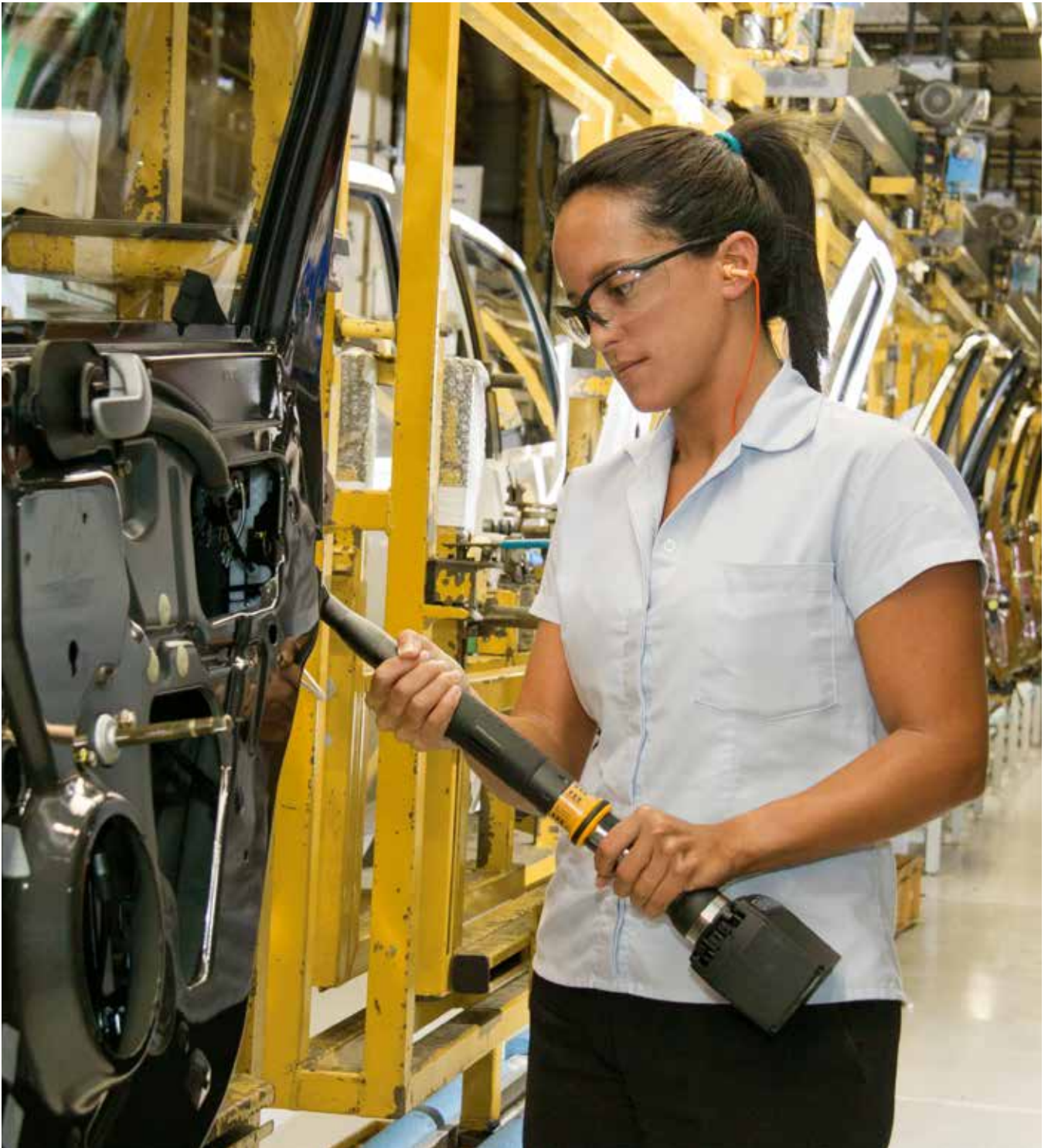

Vierkantantrieb 5/8"

Vierkantantrieb 5/8" 106

Steckschlüssel, Surface Drive, für Radmutternschrauber, mit festsitzender
Schutzhülse..... 107



Schnellwechselfutter, für Vierkantantriebe 107

Adapter, Außenvierkant mit Durchgangsbohrung..... 107

Schnellwechselfutter, Vierkantantrieb, für Bits mit Sechskant Form E 107

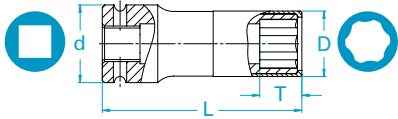

Steckschlüssel, Surface Drive, für Radmutternschrauber, mit festsitzender Schutzhülse



		Ø Antrieb d mm	Ø Abtrieb D mm	Länge L mm	Tiefe T mm	Gewicht g	max. Drehmoment Nm	Bestell- nummer	Stift und O-Ring Ref.
Zoll	mm								
5/8	17	35	27,5	90	17	306	200	4027 1488 17	R
5/8	19	35	29,5	90	19	310	200	4027 1488 19	R
5/8	21	35	31,5	90	21	310	200	4027 1488 21	R

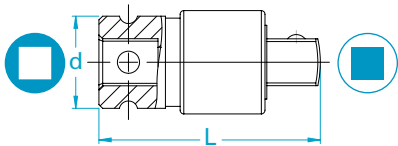

Schnellwechselfutter, für Vierkantantriebe



		Ø Antrieb d mm	Länge L mm	Gewicht g	Bestell- nummer	Stift und O-Ring Ref.
Zoll	Zoll					
5/8	5/8	35	70	306	4027 1436 10	R

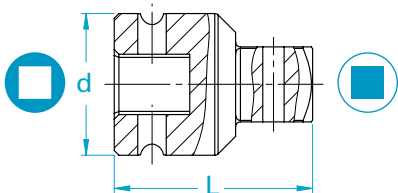

Adapter, Außenvierkant mit Durchgangsbohrung

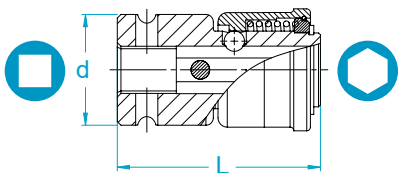

		Ø Antrieb d mm	Länge L mm	Gewicht g	Bestell- nummer	Stift und O-Ring Ref.
Zoll	Zoll					
5/8	1/2	35	46	168	4027 1435 20	R

Schnellwechselfutter, Vierkantantrieb, für Bits mit Sechskant Form E



		Ø Antrieb d mm	Länge L mm	Gewicht g	Bestell- nummer	Stift und O-Ring Ref.
Zoll	Zoll					
5/8	7/16	35	55	249	4027 1436 03	R

Vierkantantrieb 3/4"



Vierkantantrieb 3/4" 108

Steckschlüssel, Sechskant.....	109
Steckschlüssel, Sechskant, ROTACTION.....	110
Steckschlüssel, Sechskant, geführt.....	110
Steckschlüssel, Surface Drive.....	111
Steckschlüssel, Surface Drive, ROTACTION.....	111
Steckschlüssel, Doppelsechskant.....	112
Steckschlüssel, für Torx®-Schrauben.....	112
Steckschlüssel, für Torx®-Schrauben, ROTACTION.....	113
Steckschlüssel, für TorxPlus®-Schrauben.....	113
Bit Steckschlüssel, für Innensechskant-Schrauben.....	113
Bit Steckschlüssel, für Innensechskant-Schrauben, geführt.....	114
Bithalter, Vierkantantrieb, für 16 mm und 22 mm Sechskant-Bits.....	114
Bithalter, Vierkantantrieb, für 16 mm Sechskant-Bits, ROTACTION.....	114
Bithalter, Vierkantantrieb, für 16 mm Sechskant-Bits, geführt.....	114
Bits, mit 16 mm und 22 mm Sechskantantrieb, für Innensechskant-Schrauben.....	115
Bits, mit 16 mm und 22 mm Sechskantantrieb, für Torx®-Schrauben.....	115
Bits, mit 16 mm und 22 mm Sechskantantrieb, für XZN-Schrauben.....	115
Verlängerung, Außenvierkant mit Durchgangsbohrung.....	116
Verlängerung, Außenvierkant mit Durchgangsbohrung, ROTACTION.....	116
Verlängerung, Außenvierkant mit Durchgangsbohrung, geführt.....	116
Schnellwechselfutter, für Vierkantantriebe.....	117
Schnellwechselfutter, für Vierkantantriebe, ROTACTION.....	117
Gelenk Adapter, Außenvierkant mit Durchgangsbohrung.....	117
Wobble Adapter mit Feder.....	117
Adapter, Außenvierkant mit Stiftarretierung.....	118
Adapter, Außenvierkant mit Durchgangsbohrung.....	118

Steckschlüssel, Sechskant

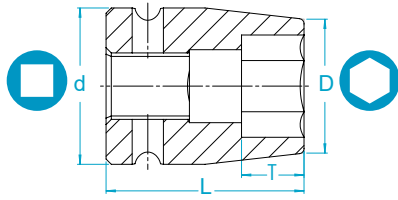

		Ø Antrieb d mm	Ø Abtrieb D mm	Länge L mm	Tiefe T mm	Gewicht g	max. Drehmoment Nm	Bestell- nummer	Stift und O-Ring Ref.
Zoll	mm								
3/4	16	44	28,8	50	11	378	600	4027 1500 16	U
3/4	16	44	28,8	100	16	514	600	4027 1503 16	U
3/4	17	44	30	50	12	370	760	4027 1500 17	U
3/4	17	44	30	100	17	534	760	4027 1503 17	U
3/4	18	44	31,3	50	13	382	924	4027 1500 18	U
3/4	18	44	31,3	100	18	560	924	4027 1503 18	U
3/4	19	44	32,5	50	13	379	1080	4027 1500 19	U
3/4	19	44	32,5	100	19	572	1080	4027 1503 19	U
3/4	21	44	35	50	15	380	1400	4027 1500 21	U
3/4	21	44	35	100	21	603	1400	4027 1503 21	U
3/4	22	44	36,3	50	15	374	1440	4027 1500 22	U
3/4	22	44	36,3	100	22	626	1440	4027 1503 22	U
3/4	24	44	38,8	50	16	382	1540	4027 1500 24	U
3/4	24	44	38,8	100	24	652	1540	4027 1503 24	U
3/4	27	44	42,5	50	16	381	1540	4027 1500 27	U
3/4	27	44	42,5	100	27	699	1540	4027 1503 27	U
3/4	30	44	46,3	53	18	416	1540	4027 1500 30	U
3/4	30	44	46,3	100	30	768	1540	4027 1503 30	U
3/4	32	44	48,8	53	19	438	1540	4027 1500 32	U
3/4	32	44	48,8	100	32	791	1540	4027 1503 32	U
3/4	33	44	50	55	20	462	1540	4027 1500 33	U
3/4	33	44	50	100	33	765	1540	4027 1503 33	U
3/4	34	44	51,3	55	20	480	1540	4027 1500 34	U
3/4	34	44	51,3	100	34	890	1540	4027 1503 34	U
3/4	36	44	53,8	55	20	510	1540	4027 1500 36	U
3/4	36	44	53,8	100	36	908	1540	4027 1503 36	U
3/4	41	44	60	57	22	609	1540	4027 1500 41	U
3/4	41	44	60	100	41	1115	1540	4027 1503 41	U
3/4	46	44	66,3	62	23	771	1540	4027 1500 46	U
3/4	50	54	71,3	62	30	930	1540	4027 1500 50	Q
Zoll	Zoll								
3/4	11/16	44	30	50	12	365	842	4027 1500 82	U
3/4	3/4	44	32,5	50	13	379	1080	4027 1500 81	U
3/4	3/4	44	32,5	100	19	576	1080	4027 1503 81	U
3/4	13/16	44	35	50	15	385	1337	4027 1500 79	U
3/4	13/16	44	35	100	21	606	1337	4027 1503 79	U
3/4	7/8	44	36,3	50	15	369	1456	4027 1500 78	U
3/4	7/8	44	36,3	100	22	618	1456	4027 1503 78	U
3/4	15/16	44	38,8	50	16	387	1531	4027 1500 77	U
3/4	15/16	44	38,8	100	24	658	1531	4027 1503 77	U
3/4	1	44	40	50	16	369	1540	4027 1500 76	U
3/4	1	44	40	100	25	658	1540	4027 1503 76	U
3/4	1,1/16	44	42,5	50	16	381	1540	4027 1500 99	U
3/4	1,1/16	44	42,5	100	27	704	1540	4027 1503 99	U
3/4	1,1/8	44	45	53	18	417	1540	4027 1500 98	U
3/4	1,1/8	44	45	100	29	756	1540	4027 1503 98	U
3/4	1,1/4	44	48,8	53	19	441	1540	4027 1500 96	U
3/4	1,1/4	44	48,8	100	32	838	1540	4027 1503 96	U
3/4	1,5/16	44	51,3	55	20	495	1540	4027 1500 94	U
3/4	1,7/16	44	55	100	37	982	1540	4027 1503 92	U
3/4	1,1/2	44	56,3	57	20	558	1540	4027 1500 91	U
3/4	1,1/2	44	56,3	100	38	1008	1540	4027 1503 91	U
3/4	1,3/4	44	65	62	23	762	1540	4027 1500 86	U
3/4	1,3/4	44	65	100	38	1264	1540	4027 1503 86	U
3/4	1,7/8	54	68,8	62	23	945	1540	4027 1500 83	Q
3/4	1,7/8	54	68,8	100	38	1496	1540	4027 1503 83	Q

Vierkanttrieb
3/4"

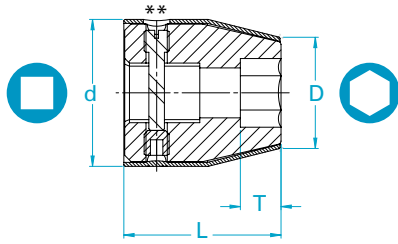

Steckschlüssel, Sechskant, ROTACTION

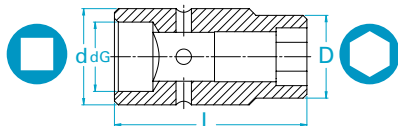

		Ø Antrieb d mm	Ø Abtrieb D mm	Länge L mm	Tiefe T mm	Gewicht g	max. Drehmoment Nm	Bestell- nummer	Steckschlüssel Abdeckung Ref.	Ersatzhülsen Bestellnummer*
Zoll	mm									
3/4	16	47	31,8	50	11	390	600	4027 1563 16	C47	4027 2982 98
3/4	16	47	31,8	100	16	546	600	4027 1544 16	C47	4027 2983 15
3/4	17	47	33	50	12	395	760	4027 1563 17	C47	4027 2982 99
3/4	17	47	33	100	17	570	760	4027 1544 17	C47	4027 2983 16
3/4	18	47	34,3	50	13	395	924	4027 1563 18	C47	4027 2983 00
3/4	18	47	34,3	100	18	589	924	4027 1544 18	C47	4027 2983 17
3/4	19	47	35,5	50	13	396	1080	4027 1563 19	C47	4027 2983 01
3/4	19	47	35,5	100	19	589	1080	4027 1544 19	C47	4027 2983 18
3/4	21	47	38	50	15	395	1400	4027 1563 21	C47	4027 2983 02
3/4	21	47	38	100	21	618	1400	4027 1544 21	C47	4027 2983 19
3/4	22	47	39,3	50	15	396	1440	4027 1563 22	C47	4027 2983 03
3/4	22	47	39,3	100	22	634	1440	4027 1544 22	C47	4027 2983 20
3/4	24	47	41,8	50	16	400	1540	4027 1563 24	C47	4027 2982 97
3/4	24	47	41,8	100	24	673	1540	4027 1544 24	C47	4027 2983 21
3/4	27	47	45,5	50	16	397	1540	4027 1563 27	C47	4027 2983 04
3/4	27	47	45,5	100	27	728	1540	4027 1544 27	C47	4027 2983 22
3/4	30	47	49,3	53	18	438	1540	4027 1563 30	C47	4027 2983 05
3/4	30	47	49,3	100	30	801	1540	4027 1544 30	C47	4027 2983 23

Steckschlüssel, Sechskant, geführt



		Ø Antrieb d mm	Ø Abtrieb D mm	Ø Führung d _g mm	Länge L mm	Tiefe T mm	Gewicht g	max. Drehmoment Nm	Bestell- nummer	Stift und O-Ring Ref.
Zoll	mm									
3/4	18	40	28	25	60	13	304	398	4026 4418 00	U
3/4	19	40	30	25	60	10	320	398	4026 4419 00	U
3/4	24	40	36	25	60	17	301	398	4026 4424 00	U
3/4	30	40	46	25	60	20	394	557	4026 4430 00	U
in	in									
3/4	3/4	40	30	25	60	10	320	398	4026 4419 00	U
3/4	15/16	40	35	25	60	12	323	398	4026 4423 00	U

*Ersatzhülsen werden als 2er Satz mit Montageanleitung geliefert.

**Abnehmbarer Gewindestift als Ersatzteil lieferbar, BestellNr. 4027911238

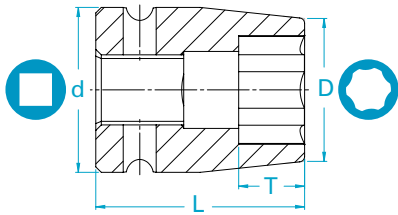

Steckschlüssel, Surface Drive

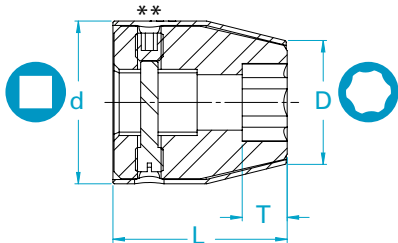

		Ø Antrieb d mm	Ø Abtrieb D mm	Länge L mm	Tiefe T mm	Gewicht g	max. Drehmoment Nm	Bestell- nummer	Stift und O-Ring Ref.
Zoll	mm								
3/4	16	44	28,8	50	11	365	600	4027 1508 16	U
3/4	16	44	28,8	100	16	520	600	4027 1510 16	U
3/4	17	44	30	50	12	370	760	4027 1508 17	U
3/4	17	44	30	100	17	534	760	4027 1510 17	U
3/4	18	44	31,3	50	13	380	924	4027 1508 18	U
3/4	18	44	31,3	100	18	549	924	4027 1510 18	U
3/4	19	44	32,5	50	13	378	1080	4027 1508 19	U
3/4	19	44	32,5	100	19	572	1080	4027 1510 19	U
3/4	21	44	35	50	15	377	1400	4027 1508 21	U
3/4	21	44	35	100	21	600	1400	4027 1510 21	U
3/4	22	44	36,3	50	15	379	1440	4027 1508 22	U
3/4	22	44	36,3	100	22	613	1440	4027 1510 22	U
3/4	24	44	38,8	50	16	382	1540	4027 1508 24	U
3/4	24	44	38,8	100	24	644	1540	4027 1510 24	U
3/4	27	44	42,5	50	16	377	1540	4027 1508 27	U
3/4	27	44	42,5	100	27	692	1540	4027 1510 27	U
3/4	30	44	46,3	53	18	412	1540	4027 1508 30	U
3/4	30	44	46,3	100	30	764	1540	4027 1510 30	U
3/4	32	44	48,8	53	19	429	1540	4027 1508 32	U
3/4	32	44	48,8	100	32	810	1540	4027 1510 32	U
3/4	33	44	50	55	20	466	1540	4027 1508 33	U
3/4	33	44	50	100	33	840	1540	4027 1510 33	U
3/4	36	44	53,8	55	20	515	1540	4027 1508 36	U
3/4	36	44	53,8	100	36	894	1540	4027 1510 36	U

Steckschlüssel, Surface Drive, ROTACTION





		Ø Antrieb d mm	Ø Abtrieb D mm	Länge L mm	Tiefe T mm	Gewicht g	max. Drehmoment Nm	Bestell- nummer	Ref. Typ	Ersatzhülsen Bestellnummer*
Zoll	mm									
3/4	16	47	31,8	50	11	390	600	4027 1511 16	C47	4027 2983 06
3/4	16	47	31,8	100	16	550	600	4027 1571 16	C47	4027 2983 24
3/4	17	47	33	50	12	392	760	4027 1511 17	C47	4027 2983 07
3/4	17	47	33	100	17	563	760	4027 1571 17	C47	4027 2983 25
3/4	18	47	34,3	50	13	393	924	4027 1511 18	C47	4027 2983 08
3/4	18	47	34,3	100	18	578	924	4027 1571 18	C47	4027 2983 26
3/4	19	47	35,5	50	13	393	1080	4027 1511 19	C47	4027 2983 09
3/4	19	47	35,5	100	19	586	1080	4027 1571 19	C47	4027 2983 27
3/4	21	47	38	50	15	392	1400	4027 1511 21	C47	4027 2983 10
3/4	21	47	38	100	21	612	1400	4027 1571 21	C47	4027 2983 28
3/4	22	47	39,3	50	15	392	1440	4027 1511 22	C47	4027 2983 11
3/4	22	47	39,3	100	22	628	1440	4027 1571 22	C47	4027 2983 29
3/4	24	47	41,8	50	16	391	1540	4027 1511 24	C47	4027 2983 14
3/4	24	47	41,8	100	24	664	1540	4027 1571 24	C47	4027 2983 30
3/4	27	47	45,5	50	16	388	1540	4027 1511 27	C47	4027 2983 12
3/4	27	47	45,5	100	27	718	1540	4027 1571 27	C47	4027 2983 31
3/4	30	47	49,3	53	18	430	1540	4027 1511 30	C47	4027 2983 13
3/4	30	47	49,3	100	30	788	1540	4027 1571 30	C47	4027 2983 32

*Ersatzhülsen werden als 2er Satz mit Montageanleitung geliefert.

**Abnehmbarer Gewindestift als Ersatzteil lieferbar, Bestellnr. 4027911238

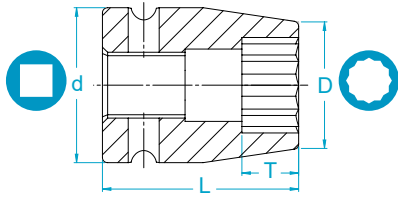
Steckschlüssel, Doppelsechskant



		Ø Antrieb d mm	Ø Abtrieb D mm	Länge L mm	Tiefe T mm	Gewicht g	max. Drehmoment Nm	Bestell- nummer	Stift und O-Ring Ref.
Zoll	mm								
3/4	16	44	28,8	50	11	377	600	4027 1515 16	U
3/4	16	44	28,8	100	16	524	600	4027 1517 16	U
3/4	17	44	30	50	12	367	760	4027 1515 17	U
3/4	17	44	30	100	17	517	760	4027 1517 17	U
3/4	18	44	31,3	50	13	372	924	4027 1515 18	U
3/4	18	44	31,3	100	18	550	924	4027 1517 18	U
3/4	19	44	32,5	50	13	370	1080	4027 1515 19	U
3/4	19	44	32,5	100	19	574	1080	4027 1517 19	U
3/4	21	44	35	50	15	374	1400	4027 1515 21	U
3/4	21	44	35	100	21	602	1400	4027 1517 21	U
3/4	22	44	36,3	50	15	373	1440	4027 1515 22	U
3/4	22	44	36,3	100	22	591	1440	4027 1517 22	U
3/4	24	44	38,8	50	16	370	1540	4027 1515 24	U
3/4	24	44	38,8	100	24	640	1540	4027 1517 24	U
3/4	27	44	42,5	50	16	375	1540	4027 1515 27	U
3/4	27	44	42,5	100	27	684	1540	4027 1517 27	U
3/4	30	44	46,3	53	18	410	1540	4027 1515 30	U
3/4	30	44	46,3	100	30	732	1540	4027 1517 30	U
3/4	32	44	48,8	53	19	428	1540	4027 1515 32	U
3/4	32	44	48,8	100	32	836	1540	4027 1517 32	U
3/4	36	44	53,8	55	20	498	1540	4027 1515 36	U
3/4	36	44	53,8	100	36	922	1540	4027 1517 36	U
in	in								
3/4	1,5/8	44	60	57	22	602	1540	4027 1515 88	U
3/4	1,11/16	44	62,5	62	23	710	1540	4027 1515 87	U
3/4	1,3/4	44	65	62	23	766	1540	4027 1515 86	U
3/4	1,7/8	54	68,8	62	23	926	1540	4027 1515 83	Q

Steckschlüssel, für Torx®-Schrauben

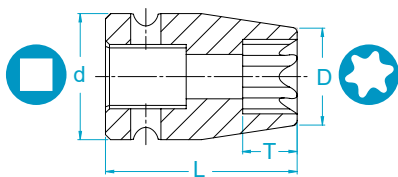

		Ø Antrieb d mm	Ø Abtrieb D mm	Länge L mm	Tiefe T mm	Gewicht g	max. Drehmoment Nm	Bestell- nummer	Stift und O-Ring Ref.
Zoll									
3/4	E18	44	26,3	50	12	359	327	4027 1520 18	U
3/4	E18	44	26,3	100	12	521	327	4027 1521 18	U
3/4	E20	44	28,8	50	13,4	372	455	4027 1520 20	U
3/4	E20	44	28,8	100	13,4	548	455	4027 1521 20	U
3/4	E22	44	31,3	50	14,5	390	629	4027 1520 22	U
3/4	E22	44	31,3	100	14,5	577	629	4027 1521 22	U
3/4	E24	44	32,5	50	16	381	806	4027 1520 24	U
3/4	E24	44	32,5	100	16	616	806	4027 1521 24	U

Torx®, Torx Plus® sind eingetragene Warenzeichen von Acument Intellectual Properties, LLC.

Steckschlüssel, für Torx®-Schrauben, ROTACTION

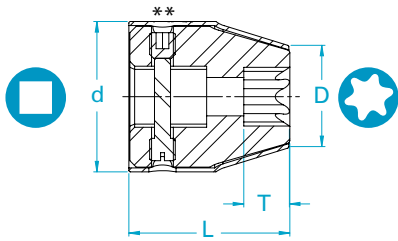

		Ø Antrieb d mm	Ø Abtrieb D mm	Länge L mm	Tiefe T mm	Gewicht g	max. Drehmoment Nm	Bestell- nummer	Steckschlüssel Abdeckung Ref.	Ersatzhülsen Bestellnummer*
Zoll										
3/4	E18	47	29,3	50	12	375	327	4027 1564 18	C47	4027 2983 33
3/4	E20	47	31,8	50	13,4	389	455	4027 1564 20	C47	4027 2983 34
3/4	E24	47	35,5	50	16	403	806	4027 1564 24	C47	4027 2983 35

Steckschlüssel, für TorxPlus®-Schrauben

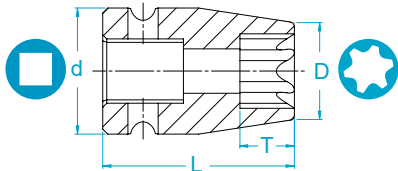

		Ø Antrieb d mm	Ø Abtrieb D mm	Länge L mm	Tiefe T mm	Gewicht g	max. Drehmoment Nm	Bestell- nummer	Stift und O-Ring Ref.
Zoll									
3/4	24EPL	44	32,5	55	12,2	426	1008	4027 1522 24	U
3/4	32EPL	44	40	62	16,1	482	1540	4027 1522 32	U

Bit Steckschlüssel, für Innensechskant-Schrauben

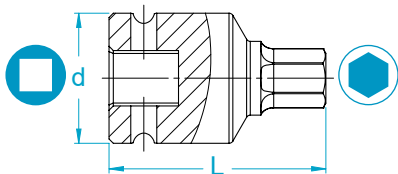

		Ø Antrieb d mm	Länge L mm	Gewicht g	max. Drehmoment Nm	Bestell- nummer	Stift und O-Ring Ref.
Zoll		mm					
3/4	12	44	62	406	336	4027 1523 12	U
3/4	14	44	62	397	479	4027 1523 14	U
3/4	17	44	62	388	796	4027 1523 17	U
3/4	19	44	66	426	1104	4027 1523 19	U
3/4	22	44	66	442	1540	4027 1523 22	U
3/4	24	44	70	504	1540	4027 1523 24	U



*Ersatzhülsen werden als 2er Satz mit Montageanleitung geliefert.

**Abnehmbarer Gewindestift als Ersatzteil lieferbar, Bestellnr. 4027911238

Torx®, Torx Plus® sind eingetragene Warenzeichen von Acument Intellectual Properties, LLC.

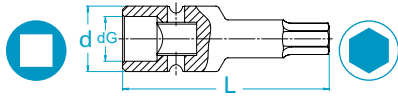

Bit Steckschlüssel, für Innensechskant-Schrauben, geführt



		Ø Antrieb d mm	Ø Führung d _g mm	Länge L mm	Gewicht g	max. Drehmoment Nm	Bestell- nummer	Stift und O-Ring Ref.
Zoll	mm							
3/4	14	44	25	75	490	479	4027 1589 14	U

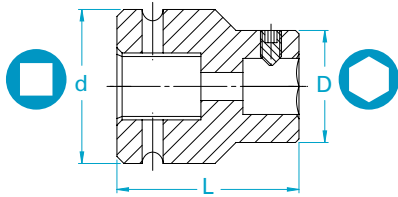

Bithalter, Vierkantantrieb, für 16 mm und 22 mm Sechskant-Bits



		Ø Antrieb d mm	Ø Abtrieb D mm	Länge L mm	Gewicht g	Bestell- nummer	Stift und O-Ring Ref.
Zoll	mm						
3/4	16	44	32	52	354	4027 1535 10	U
3/4	22	44	44	60	547	4027 1535 11	U

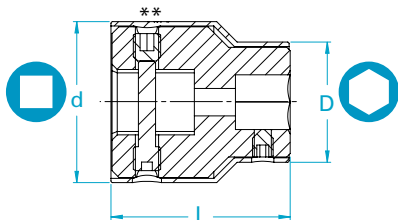

Bithalter, Vierkantantrieb, für 16 mm Sechskant-Bits, ROTACTION

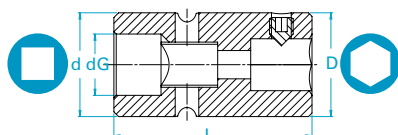

		Ø Antrieb d mm	Ø Abtrieb D mm	Länge L mm	Gewicht g	Bestell- nummer	Steckschlüssel Abdeckung Ref.	Ersatzhülsen Bestellnummer*
Zoll	mm							
3/4	16	47	35	52	390	4027 1535 16	C47	4027 2984 92

Bithalter, Vierkantantrieb, für 16 mm Sechskant-Bits, geführt





		Ø Antrieb d mm	Ø Abtrieb D mm	Ø Abtrieb D mm	Länge L mm	Gewicht g	Bestell- nummer	Stift und O-Ring Ref.
Zoll	mm							
3/4	16	44	32	25	62	440	4027 1590 10	U

*Ersatzhülsen werden als 2er Satz mit Montageanleitung geliefert.

**Abnehmbarer Gewindestift als Ersatzteil lieferbar, Bestellnr. 4027911238

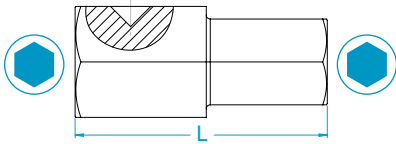

Bits, mit 16 mm und 22 mm Sechskantantrieb, für Innensechskant-Schrauben



		Länge L mm	Gewicht g	max. Drehmoment Nm	Bestell- nummer
mm	mm				
16	10	40	46	179	4027 1550 10
16	12	40	57	336	4027 1550 12
16	14	40	63	479	4027 1550 14
16	16	40	64	715	4027 1550 16
16	17	40	73	715	4027 1550 17
16	19	40	90	715	4027 1550 19
22	17	50	135	796	4027 1650 17
22	19	50	145	1104	4027 1650 19
22	22	50	162	1713	4027 1650 22
22	24	50	178	1713	4027 1650 24
22	27	50	200	1713	4027 1650 27
22	30	50	220	1713	4027 1650 30
22	32	55	268	1713	4027 1650 32

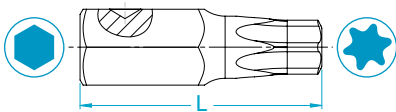

Bits, mit 16 mm und 22 mm Sechskantantrieb, für Torx®-Schrauben

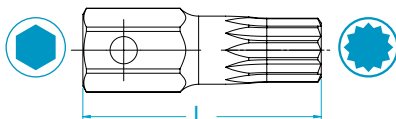

		Länge L mm	Gewicht g	max. Drehmoment Nm	Bestell- nummer
mm					
16	T55	50	59	180	4027 1552 55
16	T60	50	63	312	4027 1552 60
16	T70	50	72	491	4027 1552 70
22	T80	60	142	734	4027 1652 80
22	T90	60	155	1038	4027 1652 90
22	T100	60	170	1434	4027 1652 00

Bits, mit 16 mm und 22 mm Sechskantantrieb, für XZN-Schrauben



		Länge L mm	Gewicht g	max. Drehmoment Nm	Bestell- nummer
mm					
16	14	60	96	259	4027 1551 14
16	16	60	98	413	4027 1551 16
16	18	60	106	413	4027 1551 18

Verlängerung, Außenvierkant mit Durchgangsbohrung

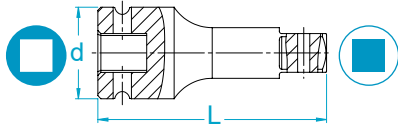

		Ø Antrieb d mm	Länge L mm	Gewicht g	Bestell- nummer	Stift und O-Ring Ref.
Zoll	Zoll					
3/4	3/4	44	125	686	4027 1534 13	U
3/4	3/4	44	175	870	4027 1534 15	U
3/4	3/4	44	250	1147	4027 1534 17	U
3/4	3/4	44	330	1464	4027 1534 18	U

Verlängerung, Außenvierkant mit Durchgangsbohrung, ROTACTION

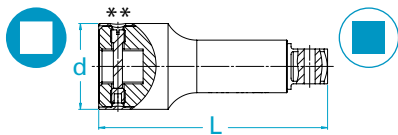

		Ø Antrieb d mm	Länge L mm	Gewicht g	Bestell- nummer	Steckschlüssel Abdeckung Ref.	Ersatzhülsen Bestellnummer*
Zoll	Zoll						
3/4	3/4	47	125	713	4027 1534 53	C47	4027 2984 29
3/4	3/4	47	175	908	4027 1534 55	C47	4027 2984 30
3/4	3/4	47	250	1200	4027 1534 57	C47	4027 2984 31

Verlängerung, Außenvierkant mit Durchgangsbohrung, geführt

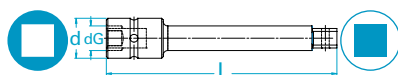

		Ø Antrieb d mm	Ø Führung d _g mm	Länge L mm	Gewicht g	Bestell- nummer	Stift und O-Ring Ref.
Zoll	Zoll						
3/4	3/4	40	25	100	476	4023 3608 01	U
3/4	3/4	40	25	150	667	4023 3609 01	U
3/4	3/4	40	25	200	860	4023 3610 01	U
3/4	3/4	40	25	250	1050	4023 3618 01	U
3/4	3/4	40	25	300	1237	4023 3619 01	U

*Ersatzhülsen werden als 2er Satz mit Montageanleitung geliefert.

**Abnehmbarer Gewindestift als Ersatzteil lieferbar, Bestellnr. 4027911238

Schnellwechselfutter, für Vierkantantriebe

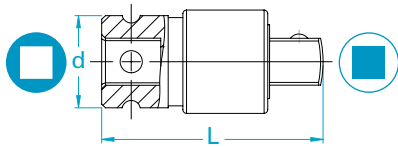

		Ø Antrieb d mm	Länge L mm	Gewicht g	Bestell- nummer	Stift und O-Ring Ref.
Zoll	Zoll					
3/4	3/4	44	75	513	4027 1536 10	U

Schnellwechselfutter, für Vierkantantriebe, ROTACTION

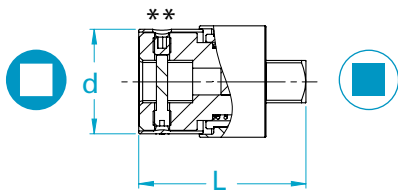

		Ø Antrieb d mm	Länge L mm	Gewicht g	Bestell- nummer	Steckschlüssel Abdeckung Ref.
Zoll	Zoll					
3/4	3/4	47	75	520	4027 1536 30	C47

Gelenk Adapter, Außenvierkant mit Durchgangsbohrung

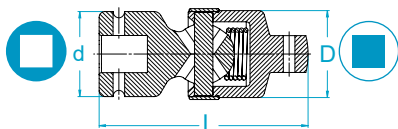

		Ø Antrieb d mm	Ø Abtrieb D mm	Länge L mm	Gewicht g	Bestell- nummer	Stift und O-Ring Ref.
Zoll	Zoll						
3/4	3/4	44	44	106	794	4027 1535 40	U

Wobble Adapter mit Feder

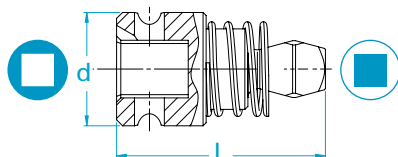



		Ø Antrieb d mm	Länge L mm	Gewicht g	max. Drehmoment Nm	Bestell- nummer	Stift und O-Ring Ref.
Zoll	Zoll						
3/4	3/4	44	75	363	472	4027 1535 50	U

**Abnehmbarer Gewindestift als Ersatzteil lieferbar, Bestellnr. 4027911238

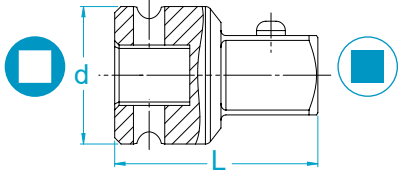

Adapter, Außenvierkant mit Stiftarretierung

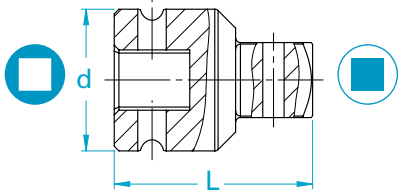

		Ø Antrieb d mm	Länge L mm	Gewicht g	Bestell- nummer	Stift und O-Ring Ref.
Zoll	Zoll					
3/4	1/2	44	54	303	4027 1535 30	U

Adapter, Außenvierkant mit Durchgangsbohrung



		Ø Antrieb d mm	Länge L mm	Gewicht g	Bestell- nummer	Stift und O-Ring Ref.
Zoll	Zoll					
3/4	1/2	44	54	295	4027 1535 20	U
3/4	5/8	44	55,5	332	4027 1535 21	U
3/4	1	44	62	430	4027 1535 22	U



Vierkantantrieb 1"

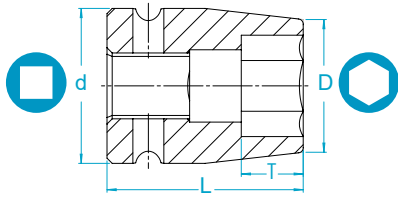

Vierkantantrieb 1"	119
Steckschlüssel, Sechskant	120
Steckschlüssel, Surface Drive	121
Bit Steckschlüssel, für Innensechskant-Schrauben	121
Bithalter, Vierkantantrieb, für 22 mm Sechskant-Bits	122
Bits, mit 22 mm Sechskantantrieb, für Innensechskant-Schrauben	122
Bits, mit 22 mm Sechskantantrieb, für Torx®-Schrauben	122
Verlängerung, Außenvierkant mit Durchgangsbohrung	123
Schnellwechselfutter, für Vierkantantriebe	123
Gelenk Adapter, Außenvierkant mit Durchgangsbohrung	123
Wobble Adapter mit Feder	124
Adapter, Außenvierkant mit Durchgangsbohrung	124

Steckschlüssel, Sechskant



		Ø Antrieb d mm	Ø Abtrieb D mm	Länge L mm	Tiefe T mm	Gewicht g	max. Drehmoment Nm	Bestell- nummer	Stift und O-Ring Ref.
Zoll	mm								
1	21	54	37,8	57	15	626	1400	4027 1600 21	T
1	21	54	37,8	108	21	960	1400	4027 1603 21	T
1	22	54	39	57	15	645	1440	4027 1600 22	T
1	22	54	39	108	22	960	1440	4027 1603 22	T
1	24	54	41,5	57	16	637	1540	4027 1600 24	T
1	24	54	41,5	108	24	944	1540	4027 1603 24	T
1	27	54	45,3	57	16	630	2520	4027 1600 27	T
1	27	54	45,3	108	27	1002	2520	4027 1603 27	T
1	30	54	49	62	21	692	2800	4027 1600 30	T
1	30	54	49	108	30	1152	2800	4027 1603 30	T
1	32	54	51,5	62	21	660	2800	4027 1600 32	T
1	32	54	51,5	108	32	1180	2800	4027 1603 32	T
1	33	54	52,8	62	21	678	2800	4027 1600 33	T
1	33	54	52,8	108	33	1200	2800	4027 1603 33	T
1	34	54	54	62	21	843	2800	4027 1600 34	T
1	36	54	56,5	62	21	713	2800	4027 1600 36	T
1	36	54	56,5	108	36	1232	2800	4027 1603 34	T
1	41	54	62,8	66	25	868	2800	4027 1600 41	T
1	41	54	62,8	108	38	1360	2800	4027 1603 36	T
1	46	54	69	70	29	1013	2800	4027 1600 46	T
1	46	54	69	108	38	1560	2800	4027 1603 41	T
1	50	54	74	70	35	1064	2800	4027 1600 50	T
1	50	54	74	108	66	1580	2800	4027 1603 46	T
1	55	54	80,3	75	39	1281	2800	4027 1600 55	T
1	55	54	80,3	108	63	1760	2800	4027 1603 50	T
1	60	54	86,5	75	39	1375	2800	4027 1600 60	T
1	60	54	86,5	108	60	1957	2800	4027 1603 55	T
1	65	54	92,8	75	38	1630	2800	4027 1600 65	T
1	70	54	99	75	37	1554	2800	4027 1600 70	T
Zoll	Zoll								
1	7/8	54	39	57	15	615	1456	4027 1600 78	T
1	7/8	54	39	108	22	960	1456	4027 1603 78	T
1	15/16	54	41,5	57	16	626	1531	4027 1600 77	T
1	15/16	54	41,5	108	24	950	1531	4027 1603 77	T
1	1	54	42,8	57	16	620	1540	4027 1600 76	T
1	1	54	42,8	108	25	985	1540	4027 1603 76	T
1	1,1/16	54	45,3	57	16	630	2520	4027 1600 99	T
1	1,1/16	54	45,3	108	27	1002	2520	4027 1603 99	T
1	1,1/8	54	47,8	57	18	648	2670	4027 1600 98	T
1	1,3/16	54	49	62	21	647	2800	4027 1600 97	T
1	1,3/16	54	49	108	30	1152	2800	4027 1603 97	T
1	1,1/4	54	51,5	62	21	655	2800	4027 1600 96	T
1	1,1/4	54	51,5	108	32	1200	2800	4027 1603 96	T
1	1,5/16	54	54	62	21	696	2800	4027 1600 94	T
1	1,1/2	54	59	66	25	780	2800	4027 1600 91	T
1	1,1/2	54	59	108	38	1323	2800	4027 1603 91	T
1	1,11/16	54	65,3	68	27	977	2800	4027 1600 87	T
1	1,7/8	54	71,5	70	35	983	2800	4027 1600 83	T
1	2	54	75,3	70	35	1092	2800	4027 1600 81	T
1	2	54	75,3	108	66	1605	2800	4027 1603 81	T
1	2,1/16	54	76,5	75	40	1185	2800	4027 1600 79	T

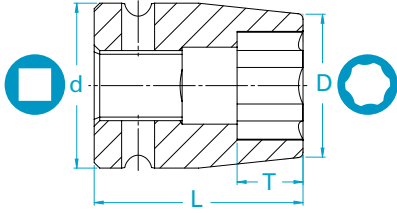

Steckschlüssel, Surface Drive

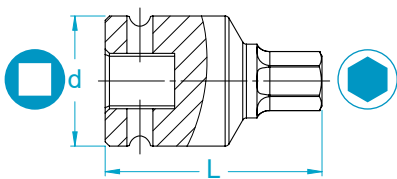

		Ø Antrieb d mm	Ø Abtrieb D mm	Länge L mm	Tiefe T mm	Gewicht g	max. Drehmoment Nm	Bestell- nummer	Stift und O-Ring Ref.
Zoll	mm								
1	21	54	37,8	57	15	585	1400	4027 1608 21	T
1	21	54	37,8	108	21	890	1400	4027 1610 21	T
1	22	54	39	57	15	640	1440	4027 1608 22	T
1	22	54	39	108	22	900	1440	4027 1610 22	T
1	24	54	41,5	57	16	634	1540	4027 1608 24	T
1	24	54	41,5	108	24	948	1540	4027 1610 24	T
1	27	54	45,3	57	16	644	2520	4027 1608 27	T
1	27	54	45,3	108	27	1008	2520	4027 1610 27	T
1	30	54	49	62	21	695	2800	4027 1608 30	T
1	30	54	49	108	30	1057	2800	4027 1610 30	T
1	32	54	51,5	62	21	671	2800	4027 1608 32	T
1	32	54	51,5	108	32	1106	2800	4027 1610 32	T
1	33	54	52,8	62	21	686	2800	4027 1608 33	T
1	33	54	52,8	108	33	1145	2800	4027 1610 33	T
1	34	54	54	62	21	675	2800	4027 1608 34	T
1	34	54	54	108	34	1159	2800	4027 1610 34	T
1	36	54	56,5	62	21	700	2800	4027 1608 36	T
1	36	54	56,5	108	36	1218	2800	4027 1610 36	T
1	41	54	62,8	66	25	846	2800	4027 1608 41	T
1	41	54	62,8	108	38	1383	2800	4027 1610 41	T
1	46	54	69	70	29	994	2800	4027 1608 46	T
1	46	54	69	108	38	1566	2800	4027 1610 46	T

Bit Steckschlüssel, für Innensechskant-Schrauben



		Ø Antrieb d mm	Länge L mm	Gewicht g	max. Drehmoment Nm	Bestell- nummer	Stift und O-Ring Ref.
Zoll	mm						
1	17	54	90	825	796	4027 1623 17	T
1	19	54	90	814	1104	4027 1623 19	T
1	22	54	90	856	1713	4027 1623 22	T
1	24	54	90	876	2233	4027 1623 24	T
1	27	54	90	915	2800	4027 1623 27	T
1	30	54	90	956	2800	4027 1623 30	T

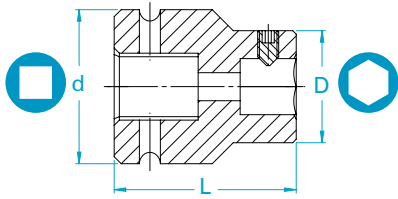

Bithalter, Vierkantantrieb, für 22 mm Sechskant-Bits



		Ø Antrieb d mm	Ø Abtrieb D mm	Länge L mm	Gewicht g	Bestell- nummer	Stift und O-Ring Ref.
Zoll	mm						
1	22	54	44	70	800	4027 1635 11	T

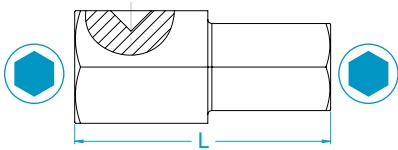

Bits, mit 22 mm Sechskantantrieb, für Innensechskant-Schrauben



		Länge L mm	Gewicht g	max. Drehmoment Nm	Bestell- nummer
mm	mm				
22	17	50	135	796	4027 1650 17
22	19	50	145	1104	4027 1650 19
22	22	50	162	1713	4027 1650 22
22	24	50	178	1713	4027 1650 24
22	27	50	200	1713	4027 1650 27
22	30	50	220	1713	4027 1650 30
22	32	55	268	1713	4027 1650 32

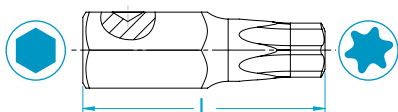

Bits, mit 22 mm Sechskantantrieb, für Torx®-Schrauben



		Länge L mm	Gewicht g	max. Drehmoment Nm	Bestell- nummer
mm					
22	T80	60	142	734	4027 1652 80
22	T90	60	155	1038	4027 1652 90
22	T100	60	170	1434	4027 1652 00

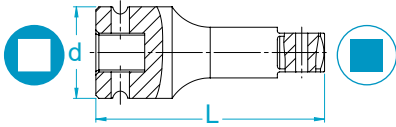

Verlängerung, Außenvierkant mit Durchgangsbohrung



		Ø Antrieb d mm	Länge L mm	Gewicht g	Bestell- nummer	Stift und O-Ring Ref.
Zoll	Zoll					
1	1	54	175	1418	4027 1634 15	T
1	1	54	250	1901	4027 1634 17	T
1	1	54	330	2461	4027 1634 18	T

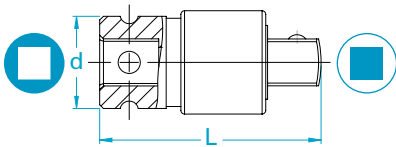

Schnellwechselfutter, für Vierkantantriebe



		Ø Antrieb d mm	Länge L mm	Gewicht g	Bestell- nummer	Stift und O-Ring Ref.
Zoll	Zoll					
1	1	54	95	990	4027 1636 10	T

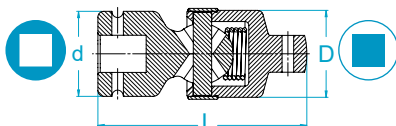

Gelenk Adapter, Außenvierkant mit Durchgangsbohrung



		Ø Antrieb d mm	Ø Abtrieb D mm	Länge L mm	Gewicht g	Bestell- nummer	Stift und O-Ring Ref.
Zoll	Zoll						
1	1	54	52	127	1315	4027 1635 40	T

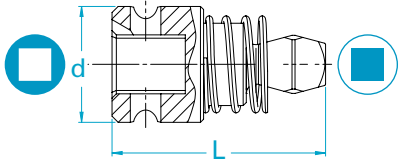

Wobble Adapter mit Feder

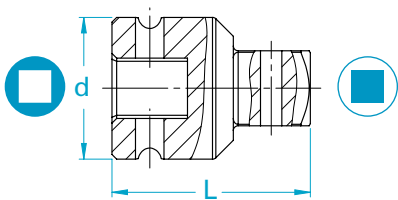

		Ø Antrieb d mm	Länge L mm	Gewicht g	max. Drehmoment Nm	Bestell- nummer	Stift und O-Ring Ref.
Zoll	Zoll						
1	1	54	90	603	784	4027 1635 50	T

Adapter, Außenvierkant mit Durchgangsbohrung



		Ø Antrieb d mm	Länge L mm	Gewicht g	Bestell- nummer	Stift und O-Ring Ref.
Zoll	Zoll					
1	3/4	54	66,5	561	4027 1635 20	T
1	1,1/2	54	80	923	4027 1635 21	T

Vierkantantrieb 1,1/2"

Vierkantantrieb 1,1/2" 125



Steckschlüssel, Sechskant..... 126

Verlängerung, Außenvierkant mit Durchgangsbohrung 126

Adapter, Außenvierkant mit Durchgangsbohrung..... 126

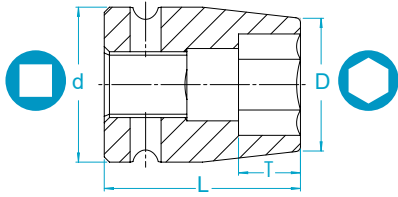

Steckschlüssel, Sechskant



		Ø Antrieb d mm	Ø Abtrieb D mm	Länge L mm	Tiefe T mm	Gewicht g	max. Drehmoment Nm	Bestell- nummer	Stift und O-Ring Ref.
Zoll	mm								
1,1/2	41	86	68	80	22	2295	10570	4027 1700 41	S
1,1/2	42	86	70	80	22	2308	10570	4027 1700 42	S
1,1/2	46	86	74	84	26	2390	10570	4027 1700 46	S
1,1/2	50	86	79	84	27	2418	10570	4027 1700 50	S
1,1/2	52	86	82	84	38	2368	10570	4027 1700 52	S
1,1/2	54	86	84	84	38	2360	10570	4027 1700 54	S
1,1/2	55	86	85	90	44	2490	10570	4027 1700 55	S
1,1/2	58	86	88	90	44	2526	10570	4027 1700 58	S
1,1/2	60	86	91	90	43	2644	10570	4027 1700 60	S
1,1/2	65	86	97	95	48	2978	10570	4027 1700 65	S
1,1/2	70	86	103	100	52	3384	10570	4027 1700 70	S
1,1/2	75	86	108	105	56	3665	10570	4027 1700 75	S
1,1/2	80	86	115	110	60	4170	10570	4027 1700 80	S
1,1/2	85	86	122	110	60	4550	10570	4027 1700 85	S
1,1/2	90	86	128	112	60	4840	10570	4027 1700 90	S
1,1/2	95	127	135	112	52	7737	10570	4027 1700 95	P
1,1/2	100	127	140	115	53	8122	10570	4027 1700 00	P
1,1/2	105	127	146	120	57	8000	10570	4027 1700 05	P
1,1/2	110	127	153	124	60	9200	10570	4027 1700 10	P
1,1/2	115	127	160	128	62	10700	10570	4027 1700 15	P
1,1/2	120	127	166	132	64	11200	10570	4027 1700 20	P
1,1/2	125	127	173	136	67	13000	10570	4027 1700 25	P
1,1/2	130	127	180	140	69	14200	10570	4027 1700 30	P
1,1/2	135	127	186	145	73	14940	10570	4027 1700 35	P
1,1/2	140	127	190	150	76	15600	10570	4027 1700 40	P
1,1/2	150	127	200	160	83	16500	10570	4027 1700 51	P

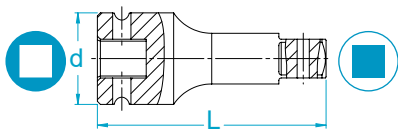

Verlängerung, Außenvierkant mit Durchgangsbohrung

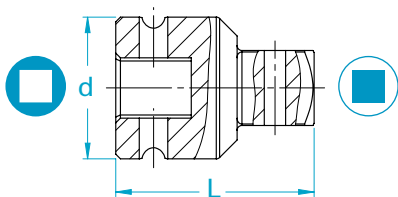

		Ø Antrieb d mm	Länge L mm	Gewicht g	Bestell- nummer	Stift und O-Ring Ref.
Zoll	Zoll					
1,1/2	1,1/2	86	175	3531	4027 1734 15	S
1,1/2	1,1/2	86	250	4500	4027 1734 17	S
1,1/2	1,1/2	86	330	5404	4027 1734 18	S

Adapter, Außenvierkant mit Durchgangsbohrung



		Ø Antrieb d mm	Länge L mm	Gewicht g	Bestell- nummer	Stift und O-Ring Ref.
Zoll	Zoll					
1,1/2	1	86	98	2290	4027 1735 20	S

Vierkantantrieb 2,1/2"





Vierkantantrieb 2,1/2" 127

Steckschlüssel, Sechskant..... 128

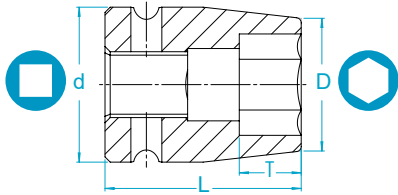
Steckschlüssel, Sechskant



		Ø Antrieb d mm	Ø Abtrieb D mm	Länge L mm	Tiefe T mm	Gewicht g	max. Drehmoment Nm	Bestell- nummer	Stift und O-Ring Ref.
Zoll	mm								
2,1/2	55	137	96	130	72	9220	10570	8434 2054 08	O
2,1/2	60	137	100	130	68	9300	10570	8434 2059 06	O
2,1/2	65	137	104	130	68	9300	10570	8434 2053 86	O
2,1/2	70	137	110	130	68	9300	10570	8434 2053 88	O
2,1/2	75	137	118	130	68	9310	10570	8434 2059 07	O
2,1/2	80	137	126	130	68	9280	10570	8434 2054 12	O
2,1/2	85	137	133	130	68	9300	10570	8434 2054 16	O
2,1/2	90	137	143	140	78	10550	10570	8434 2054 18	O
2,1/2	95	137	148	140	78	10800	10570	8434 2053 94	O
2,1/2	100	137	153	140	78	11100	10570	8434 2053 72	O
2,1/2	105	137	158	150	88	12100	10570	8434 2126 47	O
2,1/2	110	137	166	150	88	13000	10570	8434 2053 74	O
2,1/2	115	137	174	150	88	13900	10570	8434 2053 76	O
2,1/2	120	160	181	150	88	16900	10570	8434 2053 78	N
2,1/2	125	160	187	150	88	17500	10570	8434 2053 80	N
2,1/2	130	160	195	170	106	21500	10570	8434 2053 82	N
2,1/2	135	160	202	170	106	22500	10570	8434 2053 84	N
2,1/2	140	160	208	170	106	23000	10570	8434 2126 50	N
2,1/2	145	160	214	170	106	24000	10570	8434 2059 08	N
2,1/2	150	160	219	170	106	24500	10570	8434 2059 09	N
2,1/2	155	160	224	180	115	29000	10570	8434 2059 10	N
2,1/2	160	160	229	180	115	31000	10570	8434 2059 11	N
2,1/2	165	160	235	180	115	32000	10570	8434 2059 12	N
2,1/2	170	160	240	180	115	32500	10570	8434 2059 13	N
2,1/2	175	160	247	180	115	34500	10570	8434 2059 14	N
2,1/2	180	160	253	225	143	41400	10570	8434 2059 15	N
2,1/2	185	160	258	225	143	42300	10570	8434 2059 16	N
2,1/2	190	160	264	225	143	43600	10570	8434 2059 17	N
2,1/2	200	160	276	225	143	46600	10570	8434 2059 18	N
2,1/2	210	160	287	225	143	49200	10570	8434 2059 19	N
2,1/2	215	160	293	225	143	50800	10570	8434 2059 20	N
2,1/2	235	160	316	225	143	56400	10570	8434 2059 21	N
2,1/2	255	160	339	225	143	63200	10570	8434 2059 22	N
Zoll	Zoll								
2,1/2	2	137	92	130	72	9000	10570	8434 2053 85	O
2,1/2	2,3/16	137	97	130	72	8580	10570	8434 2126 53	O
2,1/2	2,3/8	137	100	130	68	9300	10570	8434 2126 56	O
2,1/2	2,7/16	137	102	130	68	9450	10570	8434 2126 59	O
2,1/2	2,9/16	137	104	130	68	9300	10570	8434 2053 86	O
2,1/2	2,3/4	137	110	130	68	9300	10570	8434 2053 88	O
2,1/2	2,15/16	137	118	130	68	9300	10570	8434 2053 90	O
2,1/2	3	137	120	130	68	9300	10570	8434 2126 62	O
2,1/2	3,1/8	137	126	130	68	9300	10570	8434 2126 65	O
2,1/2	3,1/2	137	142	140	78	10400	10570	8434 2053 92	O
2,1/2	3,5/8	137	145	140	78	10600	10570	8434 2126 68	O
2,1/2	3,3/4	137	148	140	78	10800	10570	8434 2053 94	O
2,1/2	3,7/8	137	151	140	78	11000	10570	8434 2053 96	O
2,1/2	4	137	155	140	78	11300	10570	8434 2053 98	O
2,1/2	4,1/16	137	156	150	88	12846	10570	8434 2053 99	O
2,1/2	4,1/8	137	158	150	88	12100	10570	8434 2054 00	O
2,1/2	4,1/4	137	163	150	88	12800	10570	8434 2054 02	O
2,1/2	4,3/8	137	167	150	88	13300	10570	8434 2126 71	O
2,1/2	4,5/8	160	178	150	88	15200	10570	8434 2054 04	N
2,1/2	5	160	190	170	106	21500	10570	8434 2126 74	N
2,1/2	5,3/16	160	198	170	106	22000	10570	8434 2054 06	N
2,1/2	5,3/8	160	204	170	106	23000	10570	8434 2126 77	N
2,1/2	5,3/4	160	216	170	106	25000	10570	8434 2126 80	N
2,1/2	6,1/8	160	224	180	115	30000	10570	8434 2126 83	N
2,1/2	6,1/2	160	235	180	115	32000	10570	8434 2054 10	N
2,1/2	7	160	250	180	115	35500	10570	8434 2059 23	N
2,1/2	7,5/16	160	260	225	143	47500	10570	8434 2059 24	N
2,1/2	7,13/16	160	273	225	143	49500	10570	8434 2059 25	N
2,1/2	8,7/8	160	304	225	143	62000	10570	8434 2054 14	N
2,1/2	9,1/8	160	312	225	143	65000	10570	8434 2059 26	N
2,1/2	10	160	338	225	143	70000	10570	8434 2059 27	N



Stehbolzen-Einziehwerkzeug

Stehbolzen-Einziehwerkzeug 129

Stehbolzen-Einziehwerkzeug, Vierkantantrieb mit kleinem Außendurchmesser	130
Stehbolzen-Einziehwerkzeug, Sechskantantrieb Form E	130
Stehbolzen-Einziehwerkzeug, Vierkantantrieb	130
Stehbolzen-Einziehwerkzeug, Vierkantantrieb mit Schutzring	131

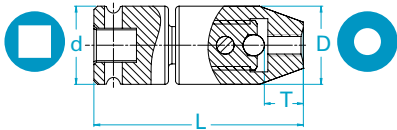

Stehbolzen-Einziehwerkzeug, Vierkantantrieb mit kleinem Außendurchmesser



		Ø Antrieb d mm	Ø Abtrieb D mm	Länge L mm	Tiefe T mm	Gewicht g	Bestell- nummer	Stift und O-Ring Ref.
Zoll								
3/8	M5	22	22	59	11	133	4027 1238 05	X
3/8	M6	22	22	59	11	135	4027 1238 06	X
3/8	M7	22	22	59	11	133	4027 2101 55	X
3/8	M8	22	22	59	11	135	4027 1238 08	X
3/8	M10	22	22	59	11	142	4027 1238 10	X

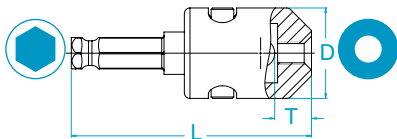

Stehbolzen-Einziehwerkzeug, Sechskantantrieb Form E



		Ø Abtrieb D mm	Länge L mm	Tiefe T mm	Gewicht g	Bestell- nummer
Zoll						
7/16	M8	32	85	13	257	4027 1020 08

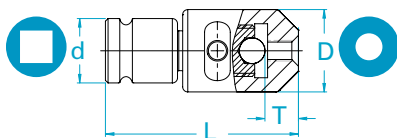

Stehbolzen-Einziehwerkzeug, Vierkantantrieb

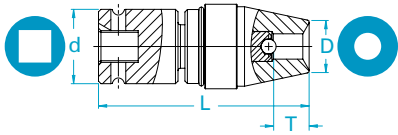

		Ø Antrieb d mm	Ø Abtrieb D mm	Länge L mm	Tiefe T mm	Gewicht g	Bestell- nummer	Stift und O-Ring Ref.
Zoll								
3/8	M8	22	32	70	13	297	4027 1239 08	X
1/2	M8	25	32	75	13	308	4027 1339 08	W
1/2	M10	25	32	75	13	309	4027 1339 10	W
1/2	M12	25	32	75	13	315	4027 1339 12	W

Stehbolzen-Einziehwerkzeug, Vierkantantrieb mit Schutzring



		Ø Antrieb d mm	Ø Abtrieb D mm	Länge L mm	Tiefe T mm	Gewicht g	Bestell- nummer	Stift und O-Ring Ref.
Zoll								
3/8	M5	22	12	70	6,3	274	4027 1237 05	X
3/8	M6	22	13	71	7,3	276	4027 1237 06	X
3/8	M8	22	15	73	9,3	310	4027 1237 08	X
3/8	M10	22	17	75	11,3	296	4027 1237 10	X
3/8	M12	22	19	77	13,3	311	4027 1237 12	X
1/2	M5	30	12	78	6,3	362	4027 1337 05	V
1/2	M6	30	13	79	7,3	366	4027 1337 06	V
1/2	M8	30	15	81	9,3	346	4027 1337 08	V
1/2	M10	30	17	83	11,3	379	4027 1337 10	V
1/2	M12	30	19	85	13,3	392	4027 1337 12	V
1/2	M14	30	20	95	21,3	618	4027 1337 14	V
1/2	M16	30	22	103	29,3	672	4027 1337 16	V
1/2	M18	30	25	103	29,3	848	4027 1337 18	V
1/2	M20	30	27	111	37,3	924	4027 1337 20	V

Stift- und O-Ring-Sets

Stift- und O-Ring-Sets

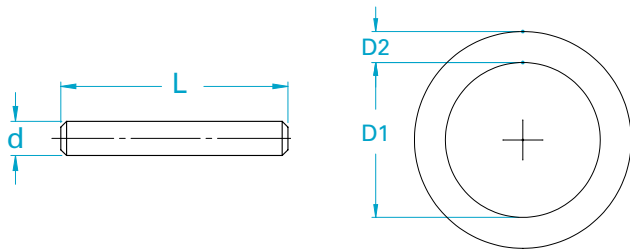

Ref. Buchst.	Ø Stift d mm	Stiftlänge L mm	Ø O-Ring D ₂ mm	Innen-Ø O-Ring D ₁ mm	Bestellnummer
Z	1,5	10	2,5	9	4027 1198 90
Y	2,5	14	3,5	13	4027 1298 90
X	2,5	16	3,5	16	4027 1298 91
W	3	20	4	19	4027 1398 90
V	3	24	4	24	4027 1398 91
R	4	30	4,5	28	4027 1498 90
U	4	36	5	36	4027 1598 90
Q	5,5	45	5	45	4027 1598 91
T	5	45	7	45	4027 1698 90
S	7	75	10	75	4027 1798 90
P	7	110	10	114	4027 1798 91
O	8	125	12	125	4027 1898 90
N	8	145	12	147	4027 1898 91

Steckschlüssel Abdeckungen und Schutzringe für ROTACTION

Steckschlüssel Abdeckungen und Schutzringe, für Vierkantantrieb, ROTACTION

Passende Schutzringe und Steckschlüssel Abdeckungen finden

- Stellen Sie fest, mit welchem Vierkantantrieb und Gewinde Ihr Atlas Copco-Werkzeug arbeitet. Zur Unterstützung befindet sich auf der nächsten Seite eine Auswahlhilfe für Schutzringe. Achten Sie auf den Antriebsdurchmesser des ausgewählten Steckschlüssels.
- In der Tabelle der Schutzringe auf der nächsten Seite finden Sie die passende Abdeckung für den Zwischenraum zwischen Werkzeug und Steckschlüssel bzw. Verlängerung.
- Bei Einsatz einer Verlängerung finden Sie die entsprechende Steckschlüssel Abdeckung für den Spalt zwischen Verlängerung und Steckschlüssel in der unteren Tabelle. Nutzen Sie auch die Referenznummern für die Steckschlüssel Abdeckungen, die in den ROTACTION-Tabellen im vorliegenden Katalog angegeben sind.

Steckschlüssel, Sechskant

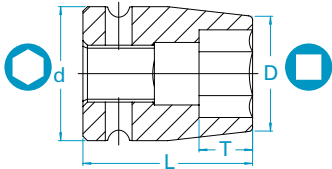

Ø Antrieb d mm		Ø Abtrieb D mm	Länge L mm	
Zoll	mm			
3/8	8	22	16,3	32
3/8	10	22	18,8	32
3/8	13	25	22,5	32
3/8	16	25	26,3	32
3/8	17	25	27,5	32
3/8	18	25	28,8	32

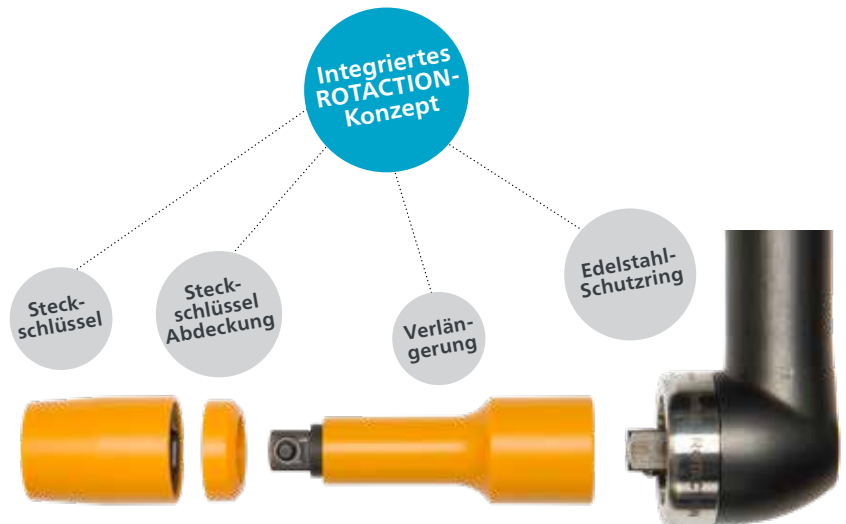

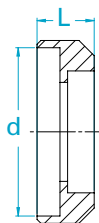

Steckschlüssel Abdeckungen, ROTACTION

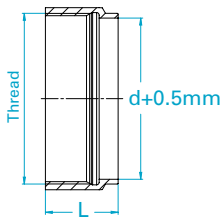

Ref. Code	Ø Antrieb d mm	Länge L mm	Bestell- nummer
	Zoll		
C16	16	5,5	4027 1197 90
C22	22	7,5	4027 1297 90
C25	25	7,5	4027 1297 91
C28	28	7,5	4027 1397 90
C33	33	7,5	4027 1397 91
C47	47	10	4027 1597 90

Schutzringe, für Werkzeuge mit Vierkantantrieb, ROTACTION





	Ø Antrieb d mm	Gewinde	Länge L mm	Gewicht g	Bestell- nummer
Zoll					
3/8	22	M24x1LH	19	50	4027 1297 00
3/8	25	M24x1LH	19	46	4027 1297 01
3/8	22	M27x0,75LH	11,7	12	4027 1297 02
3/8	25	M27x0,75LH	11,7	8	4027 1297 03
3/8	22	M34x0,75LH	11,7	24	4027 1297 04
3/8	25	M34x0,75LH	11,7	21	4027 1297 05
3/8	22	M30x0,75LH	11,7	16	4027 1297 06
3/8	25	M30x0,75LH	11,7	13	4027 1297 07
1/2	28	M30x1LH	13	40	4027 1397 00
1/2	33	M30x1LH	13	34	4027 1397 01
1/2	28	M39x1LH	17	46	4027 1397 02
1/2	33	M39x1LH	17	34	4027 1397 03
1/2	28	M43x1LH	19	70	4027 1397 04
1/2	33	M43x1LH	19	61	4027 1397 05
1/2	28	M48x1LH	19	90	4027 1397 06
1/2	33	M48x1LH	19	79	4027 1397 07
3/4	47	M34x1LH	19	150	4027 1597 00
3/4	47	MH42x1,2LH	19	115	4027 1597 01
3/4	47	MH48x1,5LH	24	135	4027 1597 02
3/4	47	MH52x1LH	19,5	75	4027 1597 03
3/4	47	M62x0,75LH	22	180	4027 1597 04

Auswahlhilfe für Schutzringe, ROTACTION

Modell		Ø Antrieb, mm (Steckschlüssel, Verlängerung usw.)	Bestellnummer
ETD DS9			
ETD DS9-270-20S	3/4	47	4027 1597 02
ETD DS9-450-20S	3/4	47	4027 1597 02
ETP DS9			
ETP DS9-270-20S	3/4	47	4027 1597 02
ETP DS9-350-20SSW	3/4	47	4027 1597 01
ETP DS9-450-20S	3/4	47	4027 1597 02
ETP DS9-500-20SSW	3/4	47	4027 1597 01
ETP DS9-600-20S	3/4	47	4027 1597 02
ETP ST101			
ETP ST101-200-20-F	3/4	47	4027 1597 00
ETP ST101-300-20-F	3/4	47	4027 1597 00
ETP ST101-500-20-F	3/4	47	4027 1597 01
ETP STR61			
ETP STR61-20	3/8	22	4027 1297 00
		25	4027 1297 01
ETP STR61-30	3/8	22	4027 1297 00
		25	4027 1297 01
ETP STR61-50	1/2	28	4027 1397 00
		33	4027 1397 01
ETP STR61-70	1/2	28	4027 1397 00
		33	4027 1397 01
ETP STR61-90	1/2	28	4027 1397 00
		33	4027 1397 01
ETP STR61-120	1/2	28	4027 1397 00
		33	4027 1397 01

Modell		Ø Antrieb, mm (Steckschlüssel, Verlängerung usw.)	Bestellnummer
ETV DS72			
ETV DS72-28	3/8	22	4027 1297 02
		25	4027 1297 03
ETV DS72-30	3/8	22	4027 1297 06
		25	4027 1297 07
ETV DS72-40	3/8	22	4027 1297 04
		25	4027 1297 05
ETV DS72-50	3/8	22	4027 1297 04
		25	4027 1297 05
ETV DS72-70	1/2	28	4027 1397 02
		33	4027 1397 03
ETV DS72-100	1/2	28	4027 1397 04
		33	4027 1397 05
ETV DS72-160	1/2	28	4027 1397 06
		33	4027 1397 07
ETV DS72-180	1/2	28	4027 1397 06
		33	4027 1397 07
ETV DS72-200-20	3/4	47	4027 1597 03
ETV DS92			
ETV DS92-100	1/2	28	4027 1397 06
		33	4027 1397 07
ETV DS92-180	1/2	28	4027 1397 06
		33	4027 1397 07
ETV DS92-270-20	3/4	47	4027 1597 03
ETV DS92-370-20	3/4	47	4027 1597 04
ETV ES21			
ETV ES21-20	3/8	22	4027 1297 02
		25	4027 1297 03

Modell		Ø Antrieb, mm (Steckschlüssel, Verlängerung usw.)	Bestellnummer
ETV ES61			
ETV ES61-25	3/8	22 25	4027 1297 02 4027 1297 03
ETV ES61-30	3/8	22 25	4027 1297 06 4027 1297 07
ETV ES61-40	3/8	22 25	4027 1297 04 4027 1297 05
ETV ES61-50	3/8	22 25	4027 1297 04 4027 1297 05
ETV ES61-70	1/2	28 33	4027 1397 02 4027 1397 03
ETV ES61-100	1/2	28 33	4027 1397 04 4027 1397 05
ETV ES61-150	1/2	28 33	4027 1397 06 4027 1397 07
ETV ES61-180	1/2	28 33	4027 1397 06 4027 1397 07
ETV ES61-200-20	3/4	47	4027 1597 03
ETV SB33			
ETV SB33-10	3/8	22 25	4027 1297 02 4027 1297 03
ETV SB33-15	3/8	22 25	4027 1297 02 4027 1297 03
ETV SB33-30	3/8	22 25	4027 1297 06 4027 1297 07
ETV SB63			
ETV SB63-40	3/8	22 25	4027 1297 04 4027 1297 05
ETV SB63-50	3/8	22 25	4027 1297 04 4027 1297 05
ETV SB63-70	1/2	28 33	4027 1397 02 4027 1397 03
ETV SB63-100	1/2	28 33	4027 1397 04 4027 1397 05
ETV SB63-140	1/2	28 33	4027 1397 06 4027 1397 07
ETV SL21			
ETV SL21-20	3/8	22 25	4027 1297 02 4027 1297 03
ETV ST31			
ETV ST31-20	3/8	22 25	4027 1297 02 4027 1297 03
ETV ST61			
ETV ST61-28	3/8	22 25	4027 1297 02 4027 1297 03
ETV ST61-30	3/8	22 25	4027 1297 06 4027 1297 07
ETV ST61-40	3/8	22 25	4027 1297 04 4027 1297 05
ETV ST61-50	3/8	22 25	4027 1297 04 4027 1297 05
ETV ST61-70	1/2	28 33	4027 1397 02 4027 1397 03
ETV ST61-100	1/2	28 33	4027 1397 04 4027 1397 05
ETV ST61-150	1/2	28 33	4027 1397 06 4027 1397 07
ETV ST61-180	1/2	28 33	4027 1397 06 4027 1397 07
ETV ST61-200-20	3/4	47	4027 1597 03
ETV ST81			
ETV ST81-50	3/8	22 25	4027 1297 04 4027 1297 05
ETV ST81-70	1/2	28 33	4027 1397 02 4027 1397 03
ETV ST81-100	1/2	28 33	4027 1397 04 4027 1397 05
ETV ST81-150	1/2	28 33	4027 1397 06 4027 1397 07
ETV ST81-180	1/2	28 33	4027 1397 06 4027 1397 07
ETV ST81-200-20	3/4	47	4027 1597 03

Modell		Ø Antrieb, mm (Steckschlüssel, Verlängerung usw.)	Bestellnummer
ETV ST101			
ETV ST101-100	1/2	28 33	4027 1397 04 4027 1397 05
ETV ST101-180	1/2	28 33	4027 1397 06 4027 1397 07
ETV ST101-200-20	3/4	47	4027 1597 03
ETV ST101-200-20F	3/4	47	4027 1597 03
ETV ST101-270-20	3/4	47	4027 1597 04
ETV ST101-270-20F	3/4	47	4027 1597 04
ETV ST101-370-20	3/4	47	4027 1597 04
ETV ST101-370-20F	3/4	47	4027 1597 04
ETV STB33			
ETV STB33-20	3/8	22 25	4027 1297 02 4027 1297 03
ETV STB33-30	3/8	22 25	4027 1297 06 4027 1297 07
ETV STB34			
ETV STB34-30	3/8	22 25	4027 1297 06 4027 1297 07
ETV STB63			
ETV STB63-30	3/8	22 25	4027 1297 06 4027 1297 07
ETV STB63-40	3/8	22 25	4027 1297 04 4027 1297 05
ETV STB63-50	3/8	22 25	4027 1297 04 4027 1297 05
ETV STB63-70	1/2	28 33	4027 1397 02 4027 1397 03
ETV STB63-100	1/2	28 33	4027 1397 04 4027 1397 05
ETV STB64			
ETV STB64-50	3/8	22 25	4027 1297 04 4027 1297 05
ETV STB64-70	1/2	28 33	4027 1397 02 4027 1397 03
ETV STB64-100	1/2	28 33	4027 1397 04 4027 1397 05
ETV STR61			
ETV STR61-25	3/8	22 25	4027 1297 02 4027 1297 03
ETV-STR61-30	3/8	22 25	4027 1297 06 4027 1297 07
ETV STR61-40	3/8	22 25	4027 1297 04 4027 1297 05
ETV STR61-50	3/8	22 25	4027 1297 04 4027 1297 05
ETV STR61-70	1/2	28 33	4027 1397 02 4027 1397 03
ETV STR61-100	1/2	28 33	4027 1397 04 4027 1397 05
ETV STR61-150	1/2	28 33	4027 1397 06 4027 1397 07
ETV STR61-180	1/2	28 33	4027 1397 06 4027 1397 07
ETV STR61-200-20	3/4	47	4027 1597 03
LMP61			
LMP61 H230-19	3/4	47	4027 1597 00
LMP61 H350-20	3/4	47	4027 1597 01
LMP61 H500-20	3/4	47	4027 1597 01
LMP61 HR230-19	3/4	47	4027 1597 00
LMP61 HR350-20	3/4	47	4027 1597 01
LMP61 HR500-20	3/4	47	4027 1597 01
LTP61			
LTP61 H230-19	3/4	47	4027 1597 00
LTP61 H350-20	3/4	47	4027 1597 01
LTP61 H500-20	3/4	47	4027 1597 01
LTP61 HR230-19	3/4	47	4027 1597 00
LTP61 HR230-19-MT	3/4	47	4027 1597 00
LTP61 HR350-20	3/4	47	4027 1597 01
LTP61 HR350-20-MT	3/4	47	4027 1597 01
LTP61 HR500-20	3/4	47	4027 1597 01
LTP61 HR500-20-MT	3/4	47	4027 1597 01
LTP61 PH230-19	3/4	47	4027 1597 00
LTP61 PH350-20	3/4	47	4027 1597 01
LTP61 PH500-20	3/4	47	4027 1597 01

Schutzringe, für Sechskantantrieb, ROTACTION

Passenden Schutzring für Werkzeuge mit 1/4"-Schnellwechselkupplung finden

1. Die in der Produkttabelle angegebene Referenz für den Schutzring verwenden.
2. Referenz aus der Auswahlhilfe für die Schutzringe hinzufügen.
3. Passenden Schutzring auswählen.

Beispiel:

- ① 1/4" Bit T20 4027 1041 31 → TC10
- ② BCP BL-2-106 → TC.3
- ③ Beide Referenzen kombinieren → TC10.3 (4027 1097 06)

Bit Steckschlüssel, für Torx®-Schrauben, mit Ringmagnet, ROTACTION



		Ø Abtrieb D mm	Länge L mm	Tiefe T mm	Gewicht g	max. Drehmoment Nm	Bestell- nummer	Werkzeugabdeckung Ref.
Zoll								
1/4	T10	9,7	150	2,1	38	3,2	4027 1043 11	TC10
1/4	T20	11,2	50	2,3	15	8,9	4027 1040 21	TC10
1/4	T20	11,2	75	2,3	20	8,9	4027 1041 21	TC10
1/4	T20	11,7	100	2,3	28	8,9	4027 1042 21	TC10
1/4	T20	11,8	150	2,3	40	8,9	4027 1043 21	TC10
1/4	T25	11,2	50	3	15	13	4027 1040 26	TC10
1/4	T25	11,2	75	3	20	13	4027 1041 26	TC10
1/4	T25	11,7	100	3	28	13	4027 1042 26	TC10
1/4	T25	11,8	150	3	40	13	4027 1043 26	TC10
1/4	T30	13,2	50	3,2	19	26	4027 1040 31	TC10
1/4	T30	13,2	75	3,2	25	26	4027 1041 31	TC10
1/4	T30	13,7	100	3,2	32	26	4027 1042 31	TC10
1/4	T30	13,8	150	3,2	48	26	4027 1043 31	TC10

Schutzringe, für Werkzeuge mit Sechskantantrieb, ROTACTION

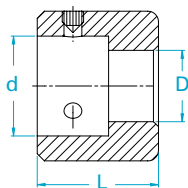

Ref. Code		Ø Antrieb d mm	Ø Abtrieb D mm	Länge L mm	Bestell- nummer
Zoll					
TC10.1	1/4	13,5	10	17	4027 1097 00
TC16.1	1/4	13,5	16	14	4027 1097 01
TC12.1	1/4	13,5	12	17	4027 1097 02
TC10.2	1/4	16,1	10	20	4027 1097 03
TC16.2	1/4	16,1	16	17	4027 1097 04
TC12.2	1/4	16,1	12	20	4027 1097 05
TC10.3	1/4	18,2	10	28	4027 1097 06
TC16.3	1/4	18,2	16	25	4027 1097 07
TC12.3	1/4	18,2	12	28	4027 1097 08
TC10.4	1/4	18/20	10	34,5	4027 1097 09
TC16.4	1/4	18/20	16	31,5	4027 1097 10
TC12.4	1/4	18/20	12	34,5	4027 1097 11

Auswahlhilfe für Schutzringe

TC.3

②

Für Modellreferenz	
BCP	
BCP BL-2-I06	TC.3
BCP BL-2L-I06	TC.3
BCP BL-6-I06	TC.3
BCP BL-6L-I06	TC.3
BCP BL-8-I06	TC.3
BCP BL-12-I06	TC.3
BCP BL-12L-I06	TC.3
BCV	
BCV BL-07-I06-QC	TC.2
EBL	
EBL20	TC.1
Winkelkopf EBL20	TC.2
EBL21	TC.1
Winkelkopf EBL21	TC.2
EBL25	TC.1
Winkelkopf EBL25	TC.2
EBL35	TC.1
Winkelkopf EBL35	TC.2
EBL45	TC.1
Winkelkopf EBL45	TC.2
EBL55	TC.1
Winkelkopf EBL55	TC.2
EP	
EP4PTX9 HR42	TC.4
EP4PTX9 SR42	TC.4
EP5PTS12 HR42	TC.4
EP5PTX12 SR42	TC.4
EP5PTX13 HR42	TC.4
EP5PTX14 SR42	TC.4
EP5PTX17 HR42	TC.4
EP5XS HR42	TC.2
EP6PS HR42	TC.4
EP6PTS20 HR42	TC.4
EP6PTX16 SR42	TC.4
EP6PTX18 SR42	TC.4
EP6PTX22 HR42	TC.4
EP6PTX28 HR42	TC.4
EP6XS HR42	TC.4
EP6XS SR42	TC.4
EP7PTS30 HR42	TC.4
EP7PTX28 SR42	TC.4
EP7XS HR42	TC.4
EP7XS SR42	TC.4
EP8PTS40 HR42	TC.4
EP8PTX38 SR42	TC.4
EP8XS HRX42	TC.4
EP8XS SR42	TC.4
ETD	
ETD ES21-02-I06	TC.2
ETD ES21-04-I06	TC.2
ETD ES21-07-I06	TC.2
ETD ES21-12-I06	TC.2
ETD M 120 ABL V2	TC.1
ETD M 200 ABL V2	TC.1
ETD M 250 ABL V2	TC.1
ETD SR21-07-I06-PS	TC.2
ETD SR21-16-I06-PS	TC.2
ETD ST31-05-I06	TC.2
ETD ST61-15-I06	TC.2

Für Modellreferenz	
ETP	
ETP DS42-20-I06S	TC.2
ETP DL21-01-I06-PS-H	TC.2
ETP DL21-04-I06	TC.2
ETP DL21-07-I06	TC.2
ETP DL21-10-I06	TC.2
ETP ES21-02-I06-PS	TC.2
ETP ES21-04-I06-PS	TC.2
ETP ES21-07-I06-PS	TC.2
ETP ES21-12-I06-PS	TC.2
ETP-ST32-05-I06	TC.2
ETP-ST32-10-I06	TC.2
ETP-ST32-20-I06	TC.2
ETP STB33-06-I06	TC.2
ETP STB33-12-I06	TC.2
ETP STB34-06-I06	TC.2
ETP STB34-12-I06	TC.2
ETP STR61-20-I06	TC.2
ETV	
ETV ES21-04-I06-QC	TC.2
ETV ES21-07-I06-QC	TC.2
ETV ES21-12-I06-QC	TC.2
ETV SL21-04-I06-QC	TC.2
ETV SL21-07-I06-QC	TC.2
ETV SL21-12-I06-QC	TC.2
LTD	
LTD13 R05-RR	TC.2
LTD13 R08-RR	TC.2
LTV	
LTV009 R05-Q	TC.2
LTV009 R07-Q	TC.2
LTV009 R07-Q-SH	TC.2
LTV009 R09-Q	TC.2
LTV009 R11-Q	TC.2
LTV009 R025-Q	TC.2
LTV009 R035-Q	TC.2
LTV19 R15-Q	TC.2
LTV28 R07-Q	TC.2
LTV28 R15-Q	TC.2
LTV29-2 R12-Q	TC.2
LTV29-2 R16-Q	TC.2
LUD	
LUD12 HRX	TC.2
LUD22 HR	TC.2
LUM	
LUM12 HRF	TC.2
LUM12 HRX	TC.2
LUM22 HR	TC.2
LUM22 HRX	TC.2
LUM32 HR	TC.2
LUM10 PR	TC.2
LUM12 PR	TC.2
LUM22 PR	TC.2
LUM12 SR	TC.2
LUM22 SR	TC.2
TWIST	
TWIST HRF	TC.2
TWIST12 HRF	TC.2
TWIST12 SR	TC.2
TWIST22 HR	TC.2
TWIST22 HRX	TC.2
TWIST22 PR	TC.2
TWIST22 SR	TC.2

Atlas Copco bietet ein breites Spektrum an Hold-and-Drive-Werkzeugen (HAD) an. Diese halten die Gewindebolzen sicher fest, während die Mutter festgezogen wird. Das Profil in dem Gewindebolzen greift in ein passendes Gegenstück bzw. in einen Bit, sodass eine Drehung des Gewindebolzens verhindert wird. Im neuen Katalog für Atlas Copco Industrial Tools & Solutions wird unser Angebot an HAD-Montagewerkzeugen und Standard-Zubehör ausführlich vorgestellt.

Schnellwechsel-Lösungen

Bei einigen Montagesituationen trägt eine speziell entwickelte, auf die jeweilige Anwendung zugeschnittene Lösung zur Steigerung der Wirtschaftlichkeit bei. Ein Beispiel hierfür sind die Schnellwechsel-Lösungen für HAD-Steckschlüssel-Bit-Kombinationen. Hier können zwei Verbindungen mit unterschiedlichen Steckschlüssel-Bit-Kombinationen mithilfe eines einzigen Montagewerkzeugs hergestellt werden.

Am ETV-HAD-Werkzeug von Atlas Copco ist ein Schnellwechseladapter (A) dauerhaft montiert. Auf diesen Adapter können verschiedene Steckschlüssel (B) aufgesetzt werden.

Diese Steckschlüssel (B) verfügen über eine integrierte Schnellwechselkupplung und können problemlos vom Adapter abgenommen oder auf diesen aufgesetzt werden. In den Schraubeinsatz ist auch eine Aufnahme für den Bit (C) integriert.

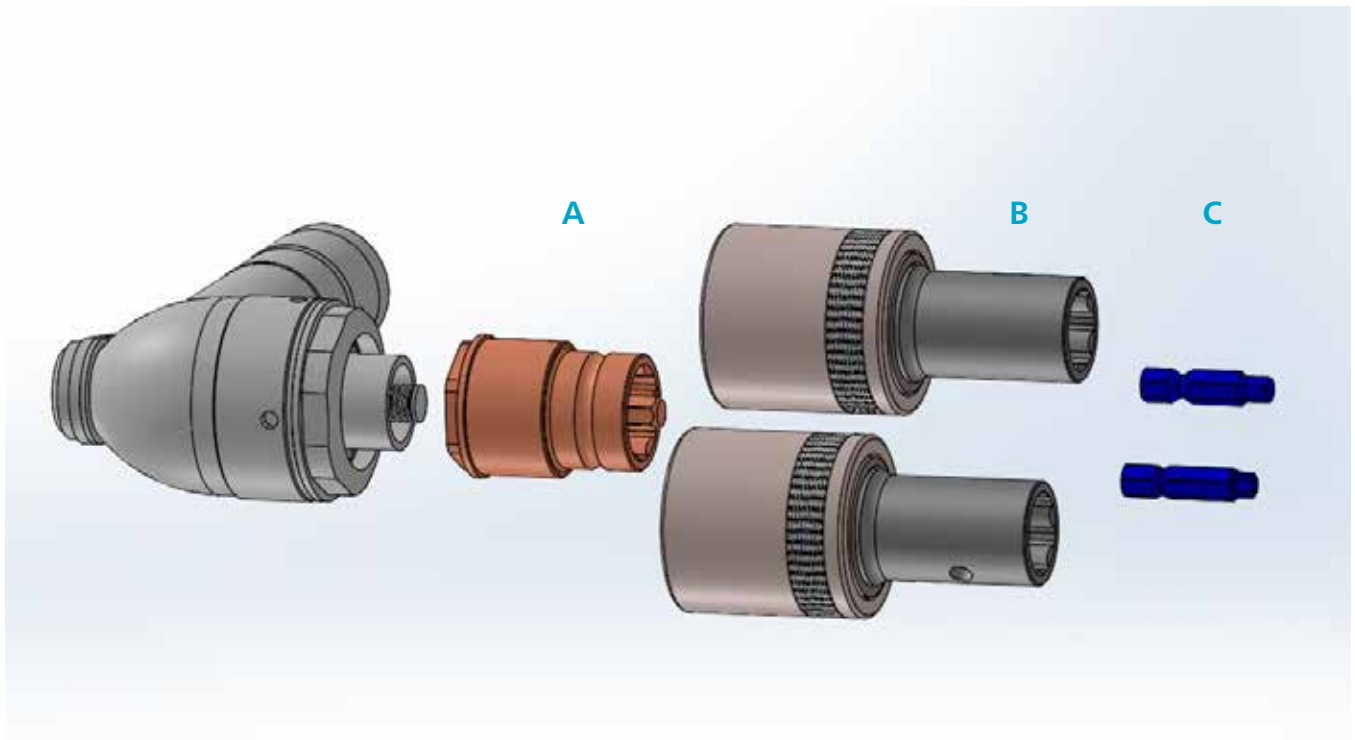

Beispiel: Schnellwechsel-Lösung für ETV STR61-50HAD

(A) Schnellwechseladapter 4027 2900 01

Erste Steckschlüssel-Bit-Kombination (Surface Drive 18 mm/Außensechskant 5 mm)

(B) auswechselbarer Steckschlüssel SD 18 mm 4027 2900 12

(C) Bit Außensechskant 5 mm 4027 2900 25

Zweite Steckschlüssel-Bit-Kombination (Surface Drive 21 mm/Torx T40)

(B) auswechselbarer Steckschlüssel SD 21 mm 4027 2900 14

(C) Bit Torx T40 4027 2900 21

(A) Schnellwechseladapter

Bestellnummer	Innen-Ø Sicherungsmutter mm	Länge (A) mm	Geeignet für
4027 2900 01	D=22	60	ETV ST61 & STR61 & ST81 up to 50-HAD
4027 2900 02	D=27	60	ETV ST61 & STR61 & ST81-100 HAD
4027 2900 03	D=35	60	ETV ST61 und STR61 und ST81-120 bis 180 HAD

(B) HAD-Steckschlüssel mit Schnellwechselfunktion

Bestellnummer	Größe Abtrieb mm	Länge (B) mm	Länge (B+C) mm	Länge (A+B+C) mm
4027 2900 10	SD16	95	100	140
4027 2900 11	SD17	95	100	140
4027 2900 12	SD18	95	100	140
4027 2900 13	SD19	95	100	140
4027 2900 14	SD21	95	100	140

(C) HAD-Bit

Bestellnummer	Größe Abtrieb	Länge (C) mm
4027 2900 20	Torx T30	35
4027 2900 21	Torx T40	35
4027 2900 22	Torx T45	35
4027 2900 23	Torx T50	35
4027 2900 24	Außensechskant 4 (mm)	35
4027 2900 25	Außensechskant 5 (mm)	35
4027 2900 26	Außensechskant 6 (mm)	35
4027 2900 27	XZN-05	35
4027 2900 28	XZN-06	35
4027 2900 29	XZN-08	35



Grundlegende Produktinformationen

Sicherheitshinweise

- Zur Gewährleistung der Sicherheit bei der Arbeit die Steckschlüssel und Bits vor der Verwendung mittels Sichtprüfung auf Schäden, Risse und Verschleiß kontrollieren.
- Steckschlüssel und Bits, die Beschädigungen bzw. Risse aufweisen oder defekt sind, dürfen nicht mehr verwendet werden und sind unverzüglich auszutauschen.
- ROTACTION-Schutzhülsen, die Beschädigungen bzw. Risse aufweisen oder defekt sind, dürfen nicht mehr verwendet werden und sind unverzüglich auszutauschen.
- Steckschlüssel und Bits mit eindeutigen Verschleißanzeichen (z. B. abgerundete Vierkantantriebe, abgerundete Sechskantprofile) sind unverzüglich auszutauschen.

Standzeit von Steckschlüsseln und Bits

Steckschlüssel und Bits sind naturgemäß Verschleißteile, die abhängig von ihrer Qualität und Verwendungshäufigkeit regelmäßig auszutauschen sind. Die nachfolgend aufgeführten Faktoren wirken sich erheblich auf die Standzeit von Steckschlüsseln aus.

Angelegtes Drehmoment

- Das angelegte Drehmoment wirkt sich auf die Standzeit aus. Je höher das Drehmoment, desto geringer die Standzeit.
- Standard-Steckschlüssel werden nach DIN 3121/3129 produziert. In diesen Normen sind die Mindest-Torsionsmomente für Prüfungen definiert.

Für Steckschlüssel und Bits in Standardausführung wird eine dauerhafte Belastung von nicht mehr als 70 % des Prüfmoments empfohlen. Dieses empfohlene maximale Drehmoment ist im Katalog angegeben.

Seitenkräfte für Steckschlüssel und Bits

Seitenkräfte wirken beispielsweise, wenn eine Vorrichtung zur Radmontage an der Montagelinie entlanggezogen wird. Die Steckschlüssel und Bits bilden die Verbindung zwischen dem sich bewegenden Fahrzeug, das sich in einer Fördereinrichtung befindet, und der mitgezogenen Radmontagevorrichtung. Diese Vorrichtung kann mit Teleskop, Dämpfung und Schienensystem schnell 300 kg und mehr auf die Waage bringen.

Versatz zwischen Steckschlüssel und Schraubenachse

Dies kann ein Winkel- und/oder Seitenversatz sein und verkürzt die Standzeit.

Speziell entwickelte/angepasste Steckschlüssel und Bits

Speziell entwickelte Steckschlüssel und Bits können von den eingangs erwähnten Standards abweichen. Dünnwandige Steckschlüssel weisen beispielsweise aufgrund der dünneren Wandstärke eine kürzere Standzeit auf als „normale“ Steckschlüssel. Hier ist ein Kompromiss zwischen Zugänglichkeit und Haltbarkeit eingegangen worden.

Material

Unser Angebot umfasst auch Steckschlüssel in „LongLife“-Versionen. Die Standzeit dieser Steckschlüssel beträgt das 7- bis 10-fache der Standzeit von Steckschlüsseln in „normaler“ Qualität und ist damit ein ausgezeichnetes Beispiel für nachhaltige Produktivität.

Garantie

Atlas Copco garantiert aufgrund der hohen Standards die Maße und Herstellungsprozesse.

Unser Lieferprogramm:

- **Industrie:** Hochwertige Industrierwerkzeuge, Druckluftwerkzeuge, Druckluftmotoren, Drehmomentarme und Handlingsysteme
- **Automotiv:** Druckluftwerkzeuge, Armaturen, Farbspritztechnik und Filtertechnik
- **Service:** Markenunabhängiger Reparaturservice für handgehaltene Druckluftwerkzeuge, Sonderanfertigungen von Druckluftwerkzeugen und Handlingsgeräten

Wir freuen uns auf Sie!

Schäffner GmbH

Bahnhofstr. 119
73430 Aalen
Baden-Württemberg
Deutschland

Tel.: +49 (0) 73 61 - 96 96 59

Fax: +49 (0) 73 61 - 96 96 61

post@schaeffner-tools.de

www.schaeffner-tools.de